

PRINCIPLES AND APPLICATIONS
IN ENGINEERING SERIES

OCCUPATIONAL ERGONOMICS

Design and Management
of Work Systems

EDITED BY

Waldemar Karwowski
William S. Marras



CRC PRESS

*Occupational Ergonomics: Design and Management of
Work Systems*

(half title)

*Occupational Ergonomics: Design and Management of
Work Systems*

Edited by

Waldemar Karwowski
University of Louisville
Louisville, Kentucky

and

William S. Marras
Ohio State University
Columbus, Ohio



CRC Press
Boca Raton New York

The material in this book was first published in *The Occupational Ergonomics Handbook*, CRC Press, Boca Raton, FL, 1999.

Library of Congress Cataloging-in-Publication Data

Occupational ergonomics : design and management of work systems / edited by Waldemar Karwowski, William S. Marras.

p. cm. — (Principles and applications in engineering ; 15)

Includes bibliographical references and index.

ISBN 0-8493-1801-7 (alk. paper)

1. Human engineering. 2. Work design. I. Karwowski, Waldemar. II. Marras, William S. (William Steven), 1952- III. Series.

TA166.0256 2003

620.8'2—dc21

2002041398

This book contains information obtained from authentic and highly regarded sources. Reprinted material is quoted with permission, and sources are indicated. A wide variety of references are listed. Reasonable efforts have been made to publish reliable data and information, but the authors and the publisher cannot assume responsibility for the validity of all materials or for the consequences of their use.

Neither this book nor any part may be reproduced or transmitted in any form or by any means, electronic or mechanical, including photocopying, microfilming, and recording, or by any information storage or retrieval system, without prior permission in writing from the publisher.

All rights reserved. Authorization to photocopy items for internal or personal use, or the personal or internal use of specific clients, may be granted by CRC Press LLC, provided that \$1.50 per page photocopied is paid directly to Copyright Clearance Center, 222 Rosewood Drive, Danvers, MA 01923 USA The fee code for users of the Transactional Reporting Service is ISBN 0-8493-1801-7/03/\$0.00+\$1.50. The fee is subject to change without notice. For organizations that have been granted a photocopy license by the CCC, a separate system of payment has been arranged.

The consent of CRC Press LLC does not extend to copying for general distribution, for promotion, for creating new works, or for resale. Specific permission must be obtained in writing from CRC Press LLC for such copying.

Direct all inquiries to CRC Press LLC, 2000 N.W. Corporate Blvd., Boca Raton, Florida 33431.

Trademark Notice: Product or corporate names may be trademarks or registered trademarks, and are used only for identification and explanation, without intent to infringe.

Visit the CRC Press Web site at www.crcpress.com

© 2003 by CRC Press LLC

No claim to original U.S. Government works

International Standard Book Number 0-8493-1801-7

Library of Congress Card Number 2002041398

Printed in the United States of America 1 2 3 4 5 6 7 8 9 0

Printed on acid-free paper

The Editors

Waldemar Karwowski, Ph.D., P.E., C.P.E., is Professor of Industrial Engineering and Director of the Center for Industrial Ergonomics at the University of Louisville, Kentucky. He holds an M.S. (1978) in production management from Technical University of Wroclaw, Poland, and a Ph.D. (1982) in Industrial Engineering from Texas Tech University. His research, teaching, and consulting activities focus on prevention of low back injury and cumulative trauma disorders, human and safety aspects of advanced manufacturing, fuzzy sets and systems, and theoretical aspects of ergonomics.

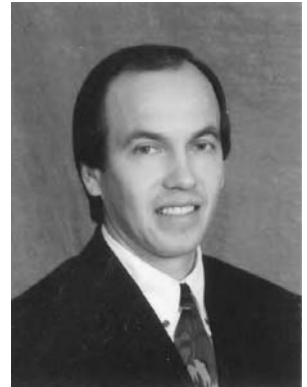

Dr. Karwowski currently serves as President of the International Ergonomics Association (2000–2003). He is an editor of many international journals, including *Human Factors and Ergonomics in Manufacturing*, and *Theoretical Issues in Ergonomics Science*, and consulting editor of *Ergonomics*. He is the author or co-author of more than 200 scientific publications, including 30 books.

Dr. Karwowski is the founder and chairman of the International Conference on Human Aspects of Advanced Manufacturing and Hybrid Automation. He was the recipient of the Outstanding Young Engineer of the Year Award, given by the Institute of Industrial Engineering. He was also a Fulbright Scholar at Tampere University of Technology in Finland. He received the President's Award for Outstanding Scholarship, Research, and Creative Activity in the category of Basic and Applied Science at the University of Louisville.

William S. Marras, Ph.D., C.P.E., holds the Honda Endowed Chair in Transportation in the Department of Industrial, Welding, and Systems Engineering at Ohio State University, Columbus. He is also the director of the biodynamics laboratory and holds appointments in the departments of physical medicine and biomedical engineering. Professor Marras is also the co-director of the Ohio State University Institute for Ergonomics.



Dr. Marras received his Ph.D. in bioengineering and ergonomics from Wayne State University in Detroit, Michigan. His research centers around biomechanical epidemiologic studies, laboratory biomechanic studies, mathematical modeling, and clinical studies of the back and wrist.

His findings have been published in more than 100 refereed journal articles and 12 book chapters. He also holds two patents, including one for the lumbar motion monitor (LMM). His work has also attracted national and international recognition. He has won the prestigious Swedish Volvo Award for Low Back Pain Research and Austria's Vienna Award for Physical Medicine.

Contributors

Thomas J. Albin

3M Center
St. Paul, MN

David C. Alexander

Auburn Engineers, Inc.
Auburn, AL

James R. Buck

Department of Industrial Engineering
University of Iowa
Iowa City, IA

Ahmet Cakir

Ergonomics Institute for Social and
Occupational Sciences
Berlin, Germany

John G. Casali

Industrial/Systems Engineering
Virginia Tech
Blacksburg, VA

Marvin J. Dainoff

Psychology Department
Miami University
Oxford, OH

Colin G. Drury

State University of New York
at Buffalo
Department of Industrial
Engineering
Buffalo, NY

Susan Evans

Sue Evans & Associates, Inc.
Ann Arbor, MI

Chris Forsythe

Statistics and Human Factors
Sandia National Labs
Albuquerque, NM

Sean Gallagher

National Institute for Occupational
Safety and Health
Pittsburgh, PA

Robert L. Getty

Lockheed Martin Tactical Aircraft
Systems
Ft. Worth, TX

Antonio Grieco

Istituto di Medicina del Lavoro
Universita di Milano
Milan, Italy

Eric Grose

Statistics and Human Factors
Sandia National Laboratories
Albuquerque, NM

Peter A. Hancock

Human Factors Research Laboratory
University of Minnesota
Minneapolis, MN

Martin G. Helander

Department of Mechanical
Engineering
Linkoping Institute of Technology
Linkoping, Sweden

Roger C. Jensen

Ergonomics Services Group
UES, Inc.
Dayton, OH

Bradley S. Joseph

Ford Motor Company
Dearborn, MI

Marilyn Joyce

Joyce Institute
Arthur D. Little, Inc.
Cambridge, MA

Karol Kerns

The MITRE Corporation
McLean, VA

Åsa Kilbom

National Institute for Working Life
Solna, Sweden

Udo Konradt

Ruhr-Universität Bochum
Bochum, Germany

Richard J. Koubek

Wright State University
Dayton, OH

Sheau-Farn Liang

Purdue University
West Lafayette, IN

William E. Lischeid

Travelers Insurance Company
Hartford, CT

Barbara Majonica

Ruhr-Universität Bochum
Bochum, Germany

C. Elaine McCoy

Ohio University
Athens, OH

Dwight P. Miller

Sandia National Laboratories
Albuquerque, NM

Giovanni Molteni

Istituto di Medicina del Lavoro
Universita di Milano
Milan, Italy

Mitsuo Nagamachi

Kure National Institute
of Technology
Hiroshima, Japan

Kageyu Noro
Ergonomics Department
Waseda University
Mikashima, Japan

Judith Orasanu
NASA
Ames Research Center
Palo Alto, CA

Gary B. Orr
US Department of Labor
OSHA
Washington, DC

Nils F. Petersson
National Institute for Working Life
Solna, Sweden

Mansour Rahimi
University of Southern California
Industrial and Systems Engineering
Los Angeles, CA

Gary S. Robinson
Industrial/Systems Engineering
Virginia Tech
Blacksburg, VA

David J. Roy
Travelers Insurance Company
Hartford, CT

Jorma Saari
University of Waterloo
Waterloo, Ontario, Canada

Steven L. Sauter
Taft Laboratories
National Institute for Occupational
Safety and Health
Cincinnati, OH

Scott P. Schneider
Ergonomics Program Director
Center to Protect Workers' Rights
Washington, DC

Juraj Sinay
Technika Universita Kosice
Kosice, Slovakia

Philip J. Smith
The Ohio State University
Columbus, OH

Carolyn M. Sommerich
Department of Industrial
Engineering
North Carolina State University
Raleigh, NC

Carol Stuart-Buttle
Stuart-Buttle Ergonomics
Philadelphia, PA

Naomi G. Swanson
Taft Laboratories
National Institute for Occupational
Safety and Health
Cincinnati, OH

Donald I. Tepas
Ergonomics Laboratory
Department of Psychology
University of Connecticut
Storrs, CT

Steven W. Thompson
United Parcel Service
Atlanta, GA

Ioannis Vasmatzidis
iNautix Technologies, Inc.
Jersey City, NJ

Donald E. Wasserman
D.E. Wasserman, Inc.
Cincinnati, OH

David G. Wilder
University of Iowa
Iowa Spine Research Center
Iowa City, IA

Bengt Å. Willén
Department of Mechanical
Engineering
Division of Industrial Ergonomics
Linköping Institute of Technology
Linköping, Sweden

Bernhard Zimolong
Ruhr-Universität Bochum
Bochum, Germany

Contents

PART I ORGANIZATIONAL DESIGN

SECTION I Ergonomics Quality and Cost-Benefit Issues

- 1 Human Factors and TQM *Colin G. Drury*.....1-1
- 2 Participatory Ergonomics *Kageyu Noro*2-1
- 3 Tuttava: A Participatory Method to Improve Ergonomics and Safety Through Better Housekeeping *Jorma Saari*.....3-1
- 4 Quality and Ergonomics: Application of Ergonomics to Continuous Improvement Is Integral to the Goals of Business *Robert L. Getty*.....4-1
- 5 Corporate Cost Avoidance Using Sound Ergonomics Technology and Quality-Based Customer Services *Dwight P. Miller*.....5-1
- 6 Economic Analysis for Ergonomics Programs *Carolyn M. Sommerich*6-1
- 7 Economic Justification of the Ergonomics Process *David C. Alexander and Thomas J. Albin*.....7-1
- 8 Economic Aiding and Economic–Ergonomic Interactions in Design and Management *James R. Buck*.....8-1
- 9 The Cost Benefit of Ergonomics: A Corporate Perspective *William E. Lischeid and David J. Roy*9-1

SECTION II Ergonomics Processes

- 10 Success Factors for Industrial Ergonomics Programs *David C. Alexander and Gary B. Orr*10-1

11	Elements of the Ergonomic Process	<i>Åsa Kilbom and Nils F. Petersson</i>	11-1
12	An Ergonomics Process: A Large Industry Perspective	<i>Bradley S. Joseph and Susan Evans</i>	12-1
13	How to Set Up Ergonomic Processes: A Small-Industry Perspective	<i>Carol Stuart-Buttle</i>	13-1
14	The Role of Ergonomics Training in Industry	<i>Marilyn Joyce</i>	14-1
15	Training Issues in Industrial Ergonomics	<i>Richard J. Koubek and Sheau-Farn Liang</i>	15-1

PART II ENVIRONMENTAL ISSUES IN ERGONOMICS

16	Noise in Industry: Auditory Effects, Measurement, Regulations, and Management	<i>John G. Casali and Gary S. Robinson</i>	16-1
17	Vibrometry	<i>Donald E. Wasserman and David G. Wilder</i>	17-1
18	On the Behavioral Basis for Stress Exposure Limits: The Foundational Case of Thermal Stress	<i>Peter A. Hancock and Ioannis Vasmatazidis</i>	18-1
19	Work Shift Usability Testing	<i>Donald I. Tepas</i>	19-1

PART III ERGONOMICS AND THE WORKING ENVIRONMENT

SECTION I The Office Environment

20	Ergonomics of Seating and Chairs	<i>Marvin J. Dainoff</i>	20-1
21	Seating and Posture in VDT Work	<i>Antonio Grieco and Giovanni Molteni</i>	21-1
22	Human–Computer Interface Requirements	<i>Ahmet Çakir</i>	22-1
23	Psychosocial Factors and Musculoskeletal Disorders in Computer Work	<i>Naomi G. Swanson and Steven L. Sauter</i>	23-1
24	User-Centered Software Development: Methodology and Usability Issues	<i>Udo Konradt, Bernhard Zimolong and Barbara Majonica</i>	24-1

SECTION II Manufacturing Systems

25 Kansei Engineering: A New Consumer-Oriented Technology for Product Development
Mitsuo Nagamachi.....25-1

26 Design for Human Assembly (DHA) *Martin G. Helander and Bengt Å. Willén*26-1

27 Human Factors in Agile Manufacturing *Chris Forsythe and Eric Grose*.....27-1

28 Occupational Safety in Robotics *Mansour Rahimi*28-1

29 Ergonomics Issues in Mining *Sean Gallagher*29-1

30 Risk Assessment and Safety Management in Industry *Juraj Sinay*30-1

SECTION III Service Systems

31 Ergonomics in Health Care Organizations *Roger C. Jensen*.....31-1

32 Ergonomics Efforts in the Package Delivery Industry *Steven W. Thompson*.....32-1

33 Ergonomics in the Construction Industry *Scott P. Schneider*.....33-1

34 Ergonomics Issues in Air Traffic Management *Karol Kerns, Philip J. Smith, C. Elaine McCoy and Judith Orasanu*.....34-1

Index I-1

Preface

Ergonomics (or human factors) is defined by the International Ergonomics Association (www.iea.cc) as *the scientific discipline concerned with the understanding of interactions among humans and other elements of a system, and the profession that applies theory, principles, data and methods to design in order to optimize human well-being and overall system performance. Ergonomists contribute to the design and evaluation of tasks, jobs, products, environments and systems in order to make them compatible with the needs, abilities and limitations of people.*

Currently, there is substantial and convincing evidence that the proficient application of ergonomics knowledge, in a system context, will help to improve system effectiveness and reliability, increase productivity, reduce employee healthcare costs, and improve the quality of work processes, products and working life for all employees. As ergonomics promotes a holistic approach in which considerations of physical, cognitive, social, organizational, environmental and other relevant factors are taken into account, the professional ergonomist should have a broad understanding of the full scope of the discipline. Development of this book was motivated by the quest to facilitate a wider acceptance of ergonomics as an effective methodology for work-system design aimed at improving the overall quality of life for millions of workers with a variety of needs and expectations.

This book focuses on selected issues in the area of occupational macroergonomics, with an emphasis on design and management of industrial work systems. This volume contains a total of 34 chapters divided in to three parts/five sections.

Part I introduces macroergonomics concepts in the design and management of work systems. Section I focuses on the quality and cost benefit issues in ergonomics management including participatory ergonomics, human aspects of total quality management (TQM), benefits of ergonomics principles applied to continuous business improvements, quality-based customer service, economic analysis and justification of ergonomics programs and corporate perspective on the cost benefit of ergonomics implementation. Section II reviews the ergonomics processes that are critical to the successful implementation of ergonomics in various industries. The discussion covers success factors of ergonomics programs, design of ergonomics process in the small and large businesses, and ergonomics training issues.

Part II of this book is concerned with environmental design including protection against noise and vibration, thermal stress, and usability of various work/shift plans.

Part III discusses applications of ergonomics principles of work design in the office environment, manufacturing and service industry. The knowledge covered in the first section includes design of seating and office chairs evaluation, posture when working with VDTs, human-computer interface design, and related psychosocial factors of musculoskeletal disorders. This section also describes methodology and

usability issues in the user-center design. The section on manufacturing systems includes a discussion about Kansei engineering, design for human assembly in manufacturing, robotics safety, and risk assessment and safety management. The last section focuses on ergonomics in service systems including healthcare, package/delivery industry, construction industry, and air traffic management.

We hope that this volume will be useful to a large number of professionals, students, and practitioners who strive to improve product and process quality, worker health and safety, and productivity in a variety of industries and businesses. We trust that the knowledge presented in this volume will help the reader learn and apply the principles on macroergonomics in the design and management of a variety of work systems.

Waldemar Karwowski
University of Louisville
Louisville, Kentucky

William S. Marras
The Ohio State University
Columbus, Ohio

Part I
Organizational Design

Section I
Ergonomics Quality and Cost-Benefit Issues

1

Human Factors and TQM

Colin G. Drury
*State University of New York
at Buffalo*

1.1	Introduction: TQM and Human Factors Programs in Industry.....	1-1
1.2	Fundamentals: The Basic Tenets of TQM and Human Factors.....	1-2
1.3	Applications of TQM and Ergonomics to Each Other.....	1-4
1.4	Summary	1-6

1.1 Introduction: TQM and Human Factors Programs in Industry

Over the past decade the pace of change in industry has been remarkable. Whether in manufacturing or service, industry has moved on an unprecedented scale to new technologies, new forms of organization, and new programs (Mize, 1992). It has not done this from an innate love of change, but because of strategic imperatives. The removal of tariff barriers and creation of trading blocs (EU, NAFTA, etc.) in the 1980s and 1990s has exposed even the smaller companies to unprecedented competition. One response in industrial countries has been to join the competition rather than fight it, for example by using manufacturing (and service) facilities in areas of relatively low labor costs. Thus, European and Japanese automobile plants have appeared in the U.S., while American apparel plants have been built in Central and South America. Even service operations, such as data entry and computer programming, have been moved “offshore” using modern communication links.

However, many companies have chosen to remain in their traditional locations and compete by application of more advanced knowledge to their business. For example, Kleiner and Drury (1996) show how a number of companies in a rust-belt region chose to remain and expand by exploiting regional knowledge and skills.

One area in which global competition has benefited companies has been the free flow of ideas, matching the freer flow of goods and services. Thus, developments in microprocessor-based technology, productivity software, organizational change, cellular manufacturing, and quality solutions arising in one country have been rapidly emulated throughout the developed (and now the developing) world. A major movement within this has been the quality imperative — the realization that without high quality, products will not sell, and the simultaneous realization that organizing for quality will produce benefits in productivity, efficiency, and safety (Crosby, 1979; Dobyns and Crawford-Mason, 1991; Krause, 1993; Deming, 1986).

Through the quality imperative in particular, companies have realized the importance of process control, i.e., ensuring that the process produces its intended output in a highly reliable manner. As more is learned about the process through quality methodologies (e.g., Statistical Process Control: Grant and Leavenworth,

1995; Designed Experiments: Taguchi, 1986), so the process can change from closed loop control using performance feedback, to open loop control using valid prediction models (Drury and Prabhu, 1994). Predictive control allows the process to operate with minimum setup time after a product change, thus facilitating moves toward just-in-time manufacturing.

The other company response to the quality imperative is the active management of quality. This has comprised both the realization that managerial leadership is important (Witcher, 1995) as are specific policies for managing quality (Deming, 1986). An obvious policy is the use of teams as both a change agent (Blest, Hunt, and Shadle, 1992) and as a natural group for controlling a process (Brennan, 1990).

At the same time that these strategy-driven changes in quality have been taking place, there have been simultaneous programs at other levels. Thus, new technology has been introduced to reduce labor costs and/or improve process capability. In response to both rising costs and public/government pressure, there has been a movement toward managing the costs associated with human errors and injuries. Company responses here have been injury reduction/safety programs (Rahimi, 1995), ergonomics programs (Liker, Joseph and Armstrong, 1984) focusing on workforce injury reduction, and similar programs for reduction of the consequences of human error (e.g., Taylor, 1990). These latter are usually termed “human factors” programs but have many characteristics in common with “industrial ergonomics” programs. Indeed, programs incorporating both injury and error reduction are possible (Drury, 1995). In this chapter the terms “ergonomics” and “human factors” will be used interchangeably.

With few exceptions, programs arising from the quality movement and the human factors movement have been simultaneous but unrelated in industry. They have many similarities and some obvious differences, but there is no *a priori* reason for them to be separate. The remainder of this chapter takes up the managerial challenge of integrating these largely parallel programs so as to gain additional benefits. For a more detailed comparison and discussion of their linkages, see Drury (1996). In particular, that paper looks at many facets of the quality movement, such as TQM, quality awards, the ISO-9000 series, and just-in-time manufacturing, while in the current chapter we concentrate on just one (TQM) for simplicity.

1.2 Fundamentals: The Basic Tenets of TQM and Human Factors

Before we can discuss interactions between the quality movement (e.g., TQM) and human factors/ergonomics, we must at least review their basic beliefs. Both programs “work” in the sense of improving industrial performance. For example, see Larson and Sinha (1995) for TQM and Drury (1992) for ergonomics.

TQM is not a monolithic philosophical structure, but rather a set of beliefs built upon the largely parallel efforts of a number of early practitioners. Rather than debate the merits of including each tenet, a recent review paper will be used to provide a convenient synopsis. Hackman and Wageman (1995) provide a thoughtful review of TQM so we will use their structure of TQM. Table 1.1 provides this in outline form and does not appear to contradict the writings of most TQM practitioners, e.g., Deming’s fourteen points (Deming, 1986). Hackman and Wageman (1995) also note two enhancements routinely used by (at least) U.S. practitioners of TQM: competitive benchmarking and employee involvement (EI). Benchmarking is the measurement of the level of performance of equivalent parts of other organizations to provide goals for those processes in your own organization. Goals are typically seen as being the best available rather than the average. Employee involvement is a generic title for a movement common in at least the larger companies to extend the employee voice in organizational affairs beyond the traditional union/management bargaining and beyond the roles specified in TQM (Russell, 1991). In fact, many companies see benchmarking and EI as integral parts of the TQM process.

Finding an equivalent set of basic beliefs or tenets of ergonomics has proven rather more difficult. As with TQM, human factors has been a largely empirical discipline, which defines what it *does* rather than its basic beliefs. Thus, societies within the International Ergonomics Association have their own definitions of ergonomics, as do textbooks and journals. Although some authors have begun to consider the under-

TABLE 1.1 Tenets of TQM

Assumptions	<ol style="list-style-type: none"> 1. Good quality is less costly to an organization than is poor workmanship. 2. Employees naturally care about quality and will take initiatives to improve it. 3. Organizations are systems of highly interdependent parts: problems cross functional lines. 4. Quality is viewed as ultimately the responsibility of top management.
Change Principles	<ol style="list-style-type: none"> 1. Focus on the work processes. 2. Uncontrolled variability is the primary cause of quality problems: it must be analyzed and controlled. 3. Management by fact: use systematically collected data throughout the problem-solving cycle. 4. The long-term health of the organization depends upon learning and continuous improvement.
Interventions	<ol style="list-style-type: none"> 1. Explicit identification and measurement of customer requirements. 2. Creation of supplier partnerships. 3. Use of cross-functional teams to identify and solve quality problems. 4. Use scientific methods to monitor performance and identify points for process improvement. 5. Use process-management heuristics to enhance team effectiveness.

Adapted from Hackman, J. R. and Wageman, R. 1995. Total quality management: empirical, conceptual, and practical issues, *Administrative Science Quarterly*, 40: 308-342.

TABLE 1.2 Tenets of Ergonomics/Human Factors

Assumptions	<ol style="list-style-type: none"> 1. Errors and stress arise when task demands are mismatched. 2. In any complex system, start with human needs and system needs, and allocate functions to meet these needs. 3. Honor thy user: use measurements and models to provide the detailed technical understanding of how people interact with systems. 4. Changing the system to fit the operator is usually preferable to changing the operator to fit the system. At least develop personnel criteria and training systems in parallel with equipment, environment, and interface. 5. Design for a range of operators rather than an average; accommodate those beyond the design range by custom modifications to equipment. 6. Operators are typically trying to do a good job within the limitations of their equipment, environment, instructions, and interfaces. When errors occur, look beyond the operator for root causes.
Change Principles	<ol style="list-style-type: none"> 1. Begin design with an analysis of system and human needs using function and task analysis. 2. Use the task analyses to discover potential as well as existing human/system mismatches. 3. Operators have an essential role in designing their own jobs and equipment, and are capable of contributing to the design process on equal terms with professional designers. 4. Optimize the job via equipment, environment, and procedures design before optimizing the operator through selection, placement, motivation, and training. 5. Use valid ergonomic techniques to measure human performance and well-being before and after the job change process.
Interventions	<ol style="list-style-type: none"> 1. Prepare well for any technical change, especially at the organizational level. 2. Involve operators throughout the change process, even those in identical jobs and on other shifts. 3. Use teams comprising operators, managers, and ergonomists (at least) to implement the change process.

pinnings of the discipline (e.g., Karwowski, Marek, and Noworol, 1988; Meister, 1996), there is no simple list of tenets similar to Table 1.1. As a working list, Table 1.2 is proposed, keeping the structure of the equivalent TQM list to facilitate comparison. Note that this listing is biased toward design ergonomics, rather than more overtly sociotechnical systems approaches (e.g., Taylor and Felten, 1993).

As is obvious from Table 1.2, ergonomics is a human-oriented process, using detailed knowledge of human functioning as a basis for designing high-performance, safe systems. Indeed, the current book gives many examples of both the detailed human knowledge, and its use in design. We now need to consider the linkages between TQM and ergonomics explicitly, to find how to manage both programs together.

1.3 Applications of TQM and Ergonomics to Each Other

As a point of departure, a comparison of Tables 1.1 and 1.2 is useful in considering the matches between TQM and ergonomics. It is immediately obvious that there are both similarities and differences between the two lists. Under Assumptions, both consider the complexity of the system (#3 for TQM, #2 for ergonomics) as an explicit element in design and analysis. Both also have a belief in the integrity of the human operator in the system (#2 in TQM, #6 in ergonomics).

At the level of change principles, TQM starts with a focus on the work process, typically the *existing* work process (#1 in TQM). Ergonomics similarly starts from the work process (#1 and #2 in ergonomics), but this is typically advocated at a function level in the sense of all possible processes which *could* perform the task, rather than in the sense of the current process.

Neither ergonomics nor TQM advocates starting from the existing *jobs*, i.e., what individuals currently do in the process. This does not stop much of current ergonomics practice being oriented toward small changes in existing jobs. Also within the Change Principles, both TQM and ergonomics advocate a measurement-based approach (#3 in TQM, #5 in ergonomics).

For Interventions, the main point of similarity is in the use of small teams to control the change process (#3 in TQM, #3 in ergonomics). In a similar vein, specific measurements are stressed as #4 in TQM corresponding to #5 in ergonomics, listed, however, under Change Principles.

In those tenets where TQM and ergonomics differ, it is primarily due to differences in level of application. TQM is concerned with the company as a whole, its customers, and suppliers. It advocates a managerial approach, emphasizing responsibility, overall costs, continuous improvement, and managerial heuristics. Human factors/ergonomics in contrast deals with the system defined in narrower mission-oriented technical terms. It advocates particular solutions (hardware before training), detailed task analysis, user involvement and use of specific data on human functioning. Ergonomics is still a technical discipline, perhaps more at a level equivalent to statistical quality/process control in TQM, than at the level of management intervention. As a single glaring example, Drury (1996) notes the almost complete absence of leadership considerations in the ergonomics/human factors literature.

With these similarities and differences in mind, we can explore some of the reported interactions between ergonomics and TQM. Practitioners of TQM have been noticeably silent on ergonomics/human factors. In the management literature, many papers examine the impact of TQM on their discipline, for example Waldman (1994) on a theory of work performance, Grant, Shari, and Krishnan (1994) on management theory, or Costigen (1995) on human resource management, but nothing on ergonomics. However, the human factors literature has reported on how the quality movement affects the human factors profession, for example Zink, Hauer, and Schmidt (1994) on quality awards or Wilson, Neely, and Chew (1993) on the effects of modern manufacturing on worker well-being. This latter is taken further by Bjorkman's (1996) analysis of the similarities and differences between various quality movements and the tenets of modern work organization design. However, there are two relatively well-developed sets of ergonomics/TQM studies. The first uses TQM ideas in safety, while the second provides evaluations of joint TQM/ergonomics programs.

In the traditional safety area, a number of authors have pointed out the similarities between safety and quality (Rahimi, 1995; Roughton, 1993; Smith and Larson, 1991; Krause, 1993). One similarity is that both have departments (safety department, quality department) which may no longer be needed with a TQM approach (Rahimi, 1995). Krause (1993) shows their similarity in the measures they use. Traditionally, both have focused on downstream measures (defects reaching the customer, injury-producing accidents), but both should move toward process measures (SPC charts, behavioral measures) to help control the downstream events nearer to their source.

Two papers show how these ideas have progressed in Finland. Vainio and Mattila (1996) integrated safety concerns within the TQM system for an electrical utility. They made safety and health an integral part of TQM largely by addressing safety and health issues within the total quality handbook. More evaluation data were provided by Saari and Laitinen (1996) in a manufacturing setting. They set up continuous improvement teams for safety, defining best work practices in each area. Then, using the mea-

surement-based TUTTAVA system, the teams set goals, made continuous improvements, and validated the results. A posture survey across the whole plant showed considerable improvement over the course of the project. In addition, injury and illness days lost were reduced by about 90% over three years.

Beyond safety is the safety role of ergonomics, typically designing to avoid injury. Here also considerable literature is developing. Stuebbe and Houshmand (1995) characterize the production system as an inadvertent injury-producing system and advocate applying quality control approaches, such as control charting, Pareto analysis, etc., to an "integrated ergonomic-quality system." This consists of analysis of the task, worker, and environment using these quality control techniques. Getty, Abbott, and Getty (1995) link quality initiatives to ergonomic projects, showing how an intervention to control cumulative trauma disorder in a panel drilling task also had a substantial effect on quality and productivity.

A major program in Sweden, the Quality, Working Environment and Productivity (QPEP) project (Axelsson, 1994; Eklund, 1995), examined specifically the linkages between quality and ergonomics in a car assembly plant. In eight departments, they produced an inventory of ergonomically demanding jobs, both those which were physically demanding and those causing production problems. Two different measures of quality showed significant differences between ergonomically good and ergonomically poor tasks, indicating the close link between ergonomics and quality.

One of the most integrated quality ergonomics efforts so far appears to be the implementation of ergonomic change within the TQM philosophy at the mail order clothing manufacturer and distributor, L. L. Bean (Rooney and Morency, 1992; Rooney, Morency, and Herrick, 1993). Their ergonomic objective was initially to eliminate the cumulative trauma disorder exposures of repetitive sewing production in a 400-person manufacturing plant. TQM was seen as defining the mission, objectives, and responsibility for safety with line management. Ergonomics moved over a six-year period from reacting to employee injuries, through proactive job design using teams, to now become part of the management and employee performance expectations and rewards.

In a follow-on paper, Rooney et al. (1993) were able to tackle some of the more deep-seated problems of repetitive work. They redesigned payment systems (with active operator involvement), replacing direct piece-rates with an annual appraisal system in which units produced were only 35 to 33% of the weighting. More complexity was built into jobs, by using cross-training and team work. Management and supervisor commitment for the ergonomics program was shown by their active support. Rooney et al. (1993) see these changes as a way of incorporating the musculoskeletal injury reduction aspects of ergonomics into a wider framework based upon macroergonomics (Hendrick, 1992) and TQM principles.

We can, however, go beyond these examples to provide managerial advice on TQM/human factors interactions, making use of similarities where they exist and exploiting differences to enhance each program. Starting with the similarities between the tenets of TQM and ergonomics (Tables 1.1 and 1.2) we can suggest, with some combining of categories:

1. *Study and Measure the Process.* Start from a systems focus rather than the current process (also advocated in Business Process Reengineering, Hammer and Champy, 1990). Use this as the basis for a detailed quantitative understanding of the process. Standard quality techniques should be used to measure process parameters, and models of human performance and well-being to measure and understand the role of the operator in the system. Use these measurements as the basis for directing and quantifying continuous improvement.
2. *Honor Thy User* (to quote Kantowitz and Sorkin, 1987). Respect the operators in the system as people trying to do their best, and having an inherent stake in performing well. Do not necessarily blame the operator alone for poor quality/productivity/safety. Tap the potential for operator-empowered improvement by giving real power to small teams which include operators. The rewards will be improvements in performance, safety, and job satisfaction.

From differences between TQM and ergonomics, we can show first how ergonomics can learn from TQM practice. These largely represent a shift from a technical process level of intervention to a more strategic, managerial level. (Longer discussions of each issue are presented in Drury, 1996.)

3. *Consider the Strategic Level.* Understand the forces beyond the process within the factory, such as requirements of the ultimate customer, and active management of the supply chain. Ensure that ergonomic interventions are truly customer-driven by explicitly measuring customer needs.
4. *Understand Leadership.* Any change activity needs responsibility of managers, up to the highest level. Do not take the mechanistic view of an organization which defines each manager by function. Understand the principles of leadership, recognize leaders, and practice leadership. All change projects need a powerful champion.
5. *Use Well-Developed Team Skills.* TQM and many other change disciplines have standard methods of starting, organizing, and running successful teams. Use these methods where they are appropriate. At least understand these methods so that you can build on the teamwork training existing within the organization from TQM programs.

Where TQM can learn from ergonomics is in the area of technical knowledge of the human operator, and how to incorporate this in process design.

6. *Use Allocation of Function Techniques.* A basic building block of human factors is the concept of function allocation, i.e., permanent or flexible assignment of logical functions between human and machine. This has been used by ergonomists at levels ranging from the whole complex system (Older, Clegg, and Waterson, 1996) to a single human-machine system (Drury, 1994). Without an explicit treatment of function allocation, technology can easily fail. For example, consider the baggage handling system at the Denver International Airport.
7. *Error-Free Manufacturing/Service.* While TQM is calling for drastic reductions in error rates, human factors is coming to grips with the causes of human error (e.g., Reason, 1990). In airline flight operations (Wiener and Nagel, 1988) and maintenance (Wenner and Drury, 1997) we have classified errors and derived logical interventions, moving from a consideration only of the accident-precipitating event to a study of root causes and latent pathogens.
8. *Interface Design.* From physical workplace layout to reduce injuries (e.g., Kroemer, Kroemer, and Kroemer-Elbert, 1994) to the interface between software and the user (Helander, 1988), human factors engineers have been designing less error-prone interfaces between people and systems. This set of techniques is largely ignored in the TQM literature, despite the latter's emphasis on error reduction, parts per million, and six-sigma processes.

1.4 Summary

In this chapter, we have examined the relationship between quality programs, specifically TQM on the one hand and ergonomics/human factors programs on the other. Simple listing of their tenets, although these may still be arguable, led to recognition of the similarities and differences between the programs. Examples of use of ergonomics within a TQM context showed that sensible linkages had already been reported.

The aim of the chapter was to find prescriptions which would help the manager exploit the similarities and differences, so as to find new linkages between human factors and TQM. Seven prescriptions are given which can lead to greater integration between the two programs in the future. Readers who *do* use these for successful integration of the human factors and the quality imperative are urged to continue to report their work in the open literature and continue the integration process for the benefit of all.

References

- Axelsson, J. R. C. 1994. Ergonomic aspects on design and quality, *IEA'94*, Vol. 4: 18-21.
- Bjorkman, T. 1996. The rationalisation movement in perspective and some ergonomic implications, *Applied Ergonomics*, 27.2: 71-77.
- Blest, J. P., Hunt, R. G. and Shadle, C. C. 1992. Action teams in the total quality process: experience in a job shop, *National Productivity Review/Spring 1992*, 195-202.

- Brennan, L. 1990. The human dimension to statistical process control within advanced manufacturing systems, in *Ergonomics of Hybrid Automated Systems II*, Eds. W. Karwowski and M. Rahimi, p. 527-534, Elsevier Science Publishers, London.
- Costigan, R. D. 1995. Adaptation of traditional human resources processes for total quality environments, *Quality Management Journal* 95 Spring, 7-23.
- Crosby, P.B. 1979. *Quality is Free, The Art of Making Quality Certain*, McGraw-Hill, New York.
- Deming, W. E. 1986. *Out of the Crisis*, Massachusetts Institute of Technology, Cambridge, Mass.
- Dobyns, L. and Crawford-Mason, C. 1991. *Quality or Else. The Revolution in World Business*, Houghton Mifflin Company, Boston.
- Drury, C. G. 1992. Ergonomics of job and equipment design, *Impact of Science on Society*, 165: 41-52.
- Drury, C. G. 1994. Function allocation in manufacturing, in *Proceedings of the Ergonomics Society 1994 Annual Conference*, Ed. S. A. Robertston, University of Warwick, 19-22 April 1994, p. 2-16.
- Drury, C. G. 1995. Work design, in *Human Factors Guide for Aviation Maintenance*, Ed. M. Maddox, Chapter 6, Federal Aviation Administration/DOT, Washington, D.C.
- Drury, C. G. 1996. Ergonomics and the quality movement. The 1996 Ergonomics Society Lecture, Leicester, U.K., 10-12 April 1996.
- Drury, C. G. and Prabhu, P. V. 1994. Human factors in test and inspection, in *Design of Work and Development of Personnel in Advanced Manufacturing*, Eds. G. Salvendy and W. Karwowski, Chapter 13, p. 355-492, John Wiley & Sons, New York.
- Eklund, J. A. E. 1995. Relationships between ergonomics and quality in assembly work. *Applied Ergonomics*, 26(1): 15-20.
- Evans, J. R. and Lindsay, W. M. 1995. *The Management and Control of Quality*, Third Edition, West Publishing Company, Minneapolis/St. Paul, MN, 143.
- Getty, R. L., Abbott, W. L. and Getty, J. M. 1995. ISO 9000 methodology enhances ergonomics effort: ergonomics becomes a tool for continuous improvement, *ASQC 49th Annual Quality Congress Proceedings*, 904-913.
- Grant, E. L. and Leavenworth, R. S. 1995. *Statistical Quality Control*, McGraw-Hill, 1984, New York.
- Grant, R. M., Shari, R. and Krishnan, R. 1994. TQM's challenge to management theory and practice, *Sloan Management Review/Winter*, 25-35.
- Hackman, J. R. and Wageman, R. 1995. Total quality management: empirical, conceptual, and practical issues, *Administrative Science Quarterly*, 40: 308-342.
- Hammer, M. and Champy, J. 1993. *Reengineering the Corporation*, Harper Business, New York.
- Helander, M., Ed. 1988. *Handbook of Human-Computer Interaction*, Elsevier Science Publishers B.V., Amsterdam, The Netherlands.
- Hendrick, H. W. 1992. A macroergonomic approach to work organization for improved safety and productivity, in *Advances in Industrial Ergonomics and Safety IV*, Ed. S. Kumar, p. 3-10, Taylor & Francis, Hampshire.
- Kantowitz, B. H. and Sorkin, R. D. 1987. Allocation of function, in *Handbook of Human Factors*, Ed. G. Salvendy, p. 355-369, John Wiley & Sons, New York.
- Karwowski, W., Marek, T. and Noworol, C. 1988. Theoretical basis of the science of ergonomics. *Ergonomics International* 88, *Proceedings of the 10th Congress of the International Ergonomics Association*, Sydney, Australia, 1-5 August 1988, Eds. A. S. Adams, R. R. Hall, B. J. McPhee and M. S. Oxenburgh, p. 756-758, Taylor & Francis, London.
- Kleiner, B. M. and Drury, C. G. 1996. Macroergonomics in regional planning and economic development in O. Brown, Jr. and H.W. Hendrick, Eds. *Human Factors in Organizational Design and Management*, 523-528.
- Krause, T. R. 1993. Safety and quality: two sides of the same coin, *Occupational Hazards*, April 1993, 47-50.
- Kroemer, K.H.E., Kroemer, H.J. and Kroemer-Elbert, K.E. 1994. *Ergonomics: How to Design for Ease and Efficiency*, Prentice Hall, Englewood Cliffs, NJ, 430-441.
- Larson, P. D. and Sinha, A. 1995. The TQM impact: a study of quality managers' perceptions, *Quality Management Journal* 95 Spring, 53-66.

- Liker, J. K., Joseph, B. S. and Armstrong, T. J. 1984. From ergonomic theory to practice: Organizational factors affecting the utilization of ergonomic knowledge, in *Human Factors in Organizational Design and Management*, Eds. H. W. Hendrick and O. Brown, Proc. 1st Symp., Honolulu, HI, August 1984, North-Holland, Amsterdam.
- Meister, D. 1996. A new theoretical structure for developmental ergonomics. Paper to 4th Pan-Pacific Conference on Occupational Ergonomics, Taipei 1996.
- Mize, J. H. 1992. Constant change, constant challenge, in *Manufacturing Systems, Foundations of World-Class Practice*, Eds. J. A. Heim and W. D. Compton, p. 196-203, National Academy Press, Washington, D.C.
- Older, M., Clegg, C. W. and Waterson, P. E. 1996. Task allocation in complex systems, in *Advances in Applied Ergonomics*, Eds. A. F. Ozok and G. Salvendy, p. 471-474, U.S.A. Publishing Corp, IN.
- Rahimi, M. 1995. Merging strategic safety, health and environment into total quality management, *International Journal of Industrial Ergonomics*, 16: 83-94, Elsevier, London.
- Reason, J. 1990. *Human Error*, Cambridge University Press, Cambridge, U.K.
- Rooney, E. F. and Morency, R. R. 1992. A practical evaluation method for quantifying ergonomic changes at L. L. Bean, in *Advances in Industrial Ergonomics and Safety IV*, Ed. S. Kumar, p. 475-481, Taylor & Francis, New York.
- Rooney, E. F., Morency, R. R. and Herrick, D. R. 1993. Macroergonomics and total quality management at L. L. Bean: a case study, in *Advances in Industrial Ergonomics and Safety V*, Eds. R. Nielsen and K. Jorgensen, p. 493-498, Taylor & Francis, New York.
- Roughton, J. 1993. TQM Integrating a total quality management system into safety and health programs. *American Society of Safety Engineers*, June 1993, 32-37.
- Russell, S. 1991. Employee involvement aspects of total quality management, *P+ European Participation Monitor*, (2): 29-32.
- Saari, J. and Laitinen, H. 1996. Towards continuous improvement of workplace, in *Advances in Applied Ergonomics*, Eds. A. F. Ozok and G. Salvendy, p. 82-87, U.S.A. Publishing Corp, IN.
- Smith, T. J. and Larson, T. L. 1991. Integrating quality management and hazard management: a behavioral cybernetic perspective, *Proceedings of the Human Factors Society 35th Annual Meeting — 1991*, 903-907.
- Stuebbe, P. A. and Houshmand, A. A. 1995. Quality and ergonomics, *Quality Management Journal 95 Winter*, 52-64.
- Taguchi, G. 1986. *Introduction to Quality Engineering*, UNIPUB, White Plains, NY.
- Taylor, J. C. and Felten, D. F. 1993. *Performance by Design*, Prentice Hall, NJ.
- Taylor, J.C. 1990. Organizational context for aircraft maintenance and inspection, in *Proceedings of the Human Factors Society 34th Annual Meeting, Volume 2*, 1176-1180.
- Vainio, P. and Mattila, M. 1996. Development of a safety and ergonomics oriented total quality system for an electricity company, in *Advances in Applied Ergonomics*, Eds. A. F. Ozok and G. Salvendy, p. 43-46, U.S.A. Publishing Corp, IN.
- Waldman, D. A. 1994. The contributions of total quality management to a theory of work performance, *Academy of Management Review 1994*, 19(3): 510-536.
- Wenner, C. and Drury, C. G. 1997. Deriving targeted interventions for ground damage, *Proceedings of the 1997 SAE Airframe Engine Maintenance & Repair Conference (AEMC '97)* August 1997, SAE Technical Paper Series 972591, Warrendale, PA.
- Wiener, E. L. and Nagel, D. C. Eds. 1988. *Human Factors in Aviation*. Academic Press, Inc., San Diego.
- Wilson, J. R., Neely, A. D. and Chew, T. 1993. Human and production requirements in modern manufacturing: complementary or contradictory? *Journal of Design and Manufacturing (1993)*, 3: 167-175.
- Witcher, B. 1995. The changing scale of total quality management, *Quality Management Journal 95 Summer*, 9-29.

Zink, K. J., Hauer, R. and Schmidt, A. 1994. Quality assessment: instruments for the analysis of quality concepts based on EN 29000, the Malcolm Baldrige Award and the European Quality Award, in *Total Quality Management*, Ed. G. K. Kanji, 5(5): 329-343, Carfax Publishing Company, UK.

For Further Information

The ideas in this chapter were based on the rather fuller treatment in Drury (1996), and the concept of tenets of the discipline reported by Hackman and Wageman (1995). The latter is a good and thoughtful review of TQM from a management viewpoint.

Standard works on TQM are Deming (1986), Evans and Lindsay (1995), and Taguchi (1986).

Excellent evaluations of the social role of TQM can be found in Wilson, Neely, and Chew (1993) and Bjorkman (1996). Comments on TQM from a sociotechnical systems viewpoint are given by Taylor and Felten (1993).

2

Participatory Ergonomics

2.1	Introduction: The Concept of Participatory Ergonomics and its Expanded Interpretation.....	2-1
2.2	Participatory Ergonomics as a Company-Wide Activity.....	2-2
2.3	Steps for Participatory Ergonomics.....	2-3
2.4	Education.....	2-3
2.5	Team Building	2-4
2.6	Measures for Occupational Safety and Health Problems and Human Errors.....	2-4
2.7	Participatory Ergonomics for Product Development and its Users	2-4
2.8	Dialogue-Style VDT Guidelines.....	2-4
2.9	Product Test Charter.....	2-5
2.10	Taking Advantage of the Internet	2-5
2.11	Common Knowledge.....	2-5
2.12	Participatory Ergonomics in Virtual Environment.....	2-7
	Presence Communication and VR • Advent of a Virtual Factory	
2.13	Conclusion: Participatory Ergonomics as Future Ergonomics.....	2-8
	Worker-Oriented Participatory Ergonomics • The Difference between Participatory Ergonomics and Macroergonomics or ODAM • More Effective Methods • Activity Linking the Community, Home and Hospitals	

Kageyu Noro
Waseda University

2.1 Introduction: The Concept of Participatory Ergonomics and its Expanded Interpretation

This chapter begins with an explanation of the conventional participatory ergonomics as applied to workers and users of a product. Then an expanded interpretation of participatory ergonomics as applied to the general public is discussed. Participatory ergonomics enables development of an information loop that facilitates ergonomic activities. Figure 2.1 shows the difference between conventional ergonomics and participatory ergonomics, using a workplace as an example. The worker becomes an actor in the process. A manager can be either an agent or an actor.

The two-way information flow shown in Figure 2.1 is achieved through the workers' active involvement at the workplace. Participatory ergonomics is the workers' active involvement in implementing ergonomic knowledge and procedures in their own workplace.

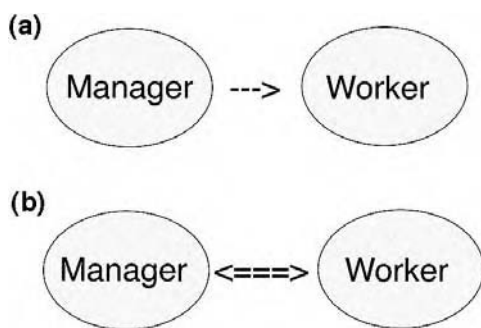

FIGURE 2.1 Two-way information flow in participatory ergonomics.

The concept of participatory ergonomics has its origins in discussions between Noro and Kazutaka Kogi in Singapore in 1983. The term *participatory ergonomics* was proposed by Kogi in a subsequent discussion (Noro and Kogi, 1985). The concept was further solidified in a workshop held by Noro (Noro, 1984) in Toronto. Noro and Imada's joint work began with informal discussions in Sacramento, California, in 1984. This was followed by a workshop which they jointly held at the first ODAM meeting in Hawaii later that year. Noro proposed the term *participatory approach* or *participatory ergonomics* for the Hawaii workshop (Noro and Imada, 1984). The participatory approach has been a major topic at all the IEA Congresses, Human Factors and Ergonomics Society Annual Meetings, and ODAM Symposia from the IEA Congress in Bournemouth in 1985, through the present day.

The original context of participatory ergonomics was workers at workplaces. This means that participatory ergonomics was interpreted as a company-wide activity. Recently, specialists have started to extend the range of application of participatory ergonomics from factory workers to product designers and users. In this latter case, participatory ergonomics aims to enhance the mutual participation of product designers and manufacturers together with the users of the product in each other's "scene." The term *scene* is used to mean the otherwise separate activities of specialists working on designing and manufacturing a product and users using the product.

The range of persons involved is expanded to include the users of a product, and the degree of reliance of the system on organizational design and management is decreased drastically. Instead, in order to function actively, the system relies heavily upon a network with an unspecified number of users and upon a common description method that the nonspecialist users can easily understand.

It is clear that the spread of the participatory approach is closely related to the interest in strengthening management of factories and enterprises since the early 1980s. While participatory ergonomics was first applied in the closed loops and controlled environments of such enterprises, it has recently been applied in the more open environment of the wider society. This change has been made possible largely by having the technological means — for example, email, inter/intranet and virtual reality — to communicate the message of participatory ergonomics. Participatory ergonomics has expanded from a typically company-wide activity to one involving the more diverse activities of members of society as a whole. Since ergonomics plays an increasing role in all aspects of our daily life, this sort of expansion of its approach and application is natural and is set to become a dominant development in ergonomics from now on.

The two types of participatory ergonomics summarized above are further described — first in the context of companies and enterprises and then in the wider context.

2.2 Participatory Ergonomics as a Company-Wide Activity

Noro stated (1991) that participatory ergonomics across the company was rooted in the influence of "small group activity" which started to be employed as part of the product quality control system (kaizen) that had been one of the basic technologies of Japan's rapid economic growth from the 1970s to the 1980s. Noro (1988) carefully examined 313 kaizen-related reports at the Nippon Steel Corporation's

TABLE 2.1 Recommended Steps for Participatory Ergonomics

Step 1: Selecting a theme
Step 2: Establishing a goal
Step 3: Understanding the situation and analyzing the factors
Step 4: Identifying the problems
Step 5: Developing and improving measures to solve the problems
Step 6: Confirming the effects of the measures taken

Source: Noro, K. 1991. Concepts, methods and people, in *Participatory Ergonomics*, Eds. K. Noro and A. Imada, p. 13, Taylor & Francis, London.

Yawata Works in the early 1980s. He found that one third of all the reports were about ergonomics. These reports written by factory workers were included in the first chapter of the resulting book (Noro, 1991). The ergonomic tools described there are a variety of creative and well-devised ideas that actually came from factory workers at their own workplaces and not from specialists or managers. The workers are, in this case, the actors typically working in small groups. Their ideas range from a campaign called “0.1-s Operation” to avoid wasting even 0.1 seconds during work to a fault tree drawn by the workers themselves.

2.3 Steps for Participatory Ergonomics

Noro (1991) recommended the steps listed in Table 2.1 for participatory ergonomics. Table 2.1. As already mentioned, the participatory approach has become one of the most discussed topics in ergonomics, and a number of reports on the subject have been published since the late 1980s. A selection of these publications is reported here. These cases are significantly different from the reports included in Noro's study (1991) mentioned above. Noro included in his report information conveyed from the workers to the management that would be too inconspicuous for a specialist to take notice of but was actually very important. In the following cases specialists, namely “agents,” have carried out participatory ergonomics.

In addition to those listed in Table 2.1, there are other suggestions for the general process of participatory ergonomics. Kuorinka (1995) suggested the following outline for the general process:

1. Clarify the essence of the problem and establish a goal
2. Generalize and prioritize the measures
3. Implement the measures
4. Follow up

A step-by-step approach according to Vink (1995) would be to

1. Prepare (decide the objective and the framework of the project)
2. Analyze work and health
3. Select measures
4. Implement the measures
5. Evaluate

2.4 Education

It is important that not only actors but also agents participate in education in order to carry out participatory ergonomics smoothly. Garmer et al. (1995) report on a coeducational program among workers, technicians, and managers. The program was implemented using a participatory ergonomics approach to promote participation of workers at an automobile assembly factory. In this factory, a tilting car body mounting system was being introduced that rotates and allows workers to adjust its height so that the workers can do 80% of the assembly work while standing upright. Alongside the introduction of this mounting device, a coeducational program among workers, technicians, and managers was developed using a dialogue-style model. In the model, personnel and labor management took the role of the agent and the operator, and the production engineer took the role of the actor.

It is important to give information about better working postures and warnings about postures that are harmful when using the lifting devices in the factory. A real-time posture input system (Kawano, 1996) was developed to instruct workers and to help them to easily and quickly understand the study results while participating for a short period of time. The device allows a worker to check his or her posture with a puppet-like device; the torques acting at body joints are displayed on a monitor. This acted as a support system for consultation regarding working posture.

2.5 Team Building

Building a team generally plays a part in participatory ergonomics as typified in this example from a red meat packing company. The team analyzed musculoskeletal injuries and hazards (Moore and Garg, 1996). The objective was to address previously unsolved problems and a high job turnover rate. A problem-solving method was identified using principles related to the product quality improvement process. The workers participated in the problem solution process. The largest obstacle for this team was in scheduling the meetings.

2.6 Measures for Occupational Safety and Health Problems and Human Errors

Participatory ergonomics is suitable for solving occupational safety, health problems, and human error. Kuorinka (1995) reports an example of a team activity to reduce human errors in handling radioactive material. The essential factors for this team activity were a formal procedure to serve as a guideline for participants, a process analysis methodology creating a customer-oriented culture among the engineering staff and team building techniques (Caccamise, 1995).

Participatory ergonomics is also effective for office work. Participatory ergonomics employed in a salary distribution department in a Dutch government ministry is reported by Vink et al. (1995). The purpose was to reduce mental and physical workload. A strong commitment from management was obtained in this example which used a step-by-step approach. The merit of this step-by-step approach in participatory ergonomics was that it was possible to systemize the process and make all the participants aware of the necessity for improvement. The drawback was that the step-by-step approach took too much time.

2.7 Participatory Ergonomics for Product Development and its Users

Although VDTs and chairs are used largely in the workplace, computers have evolved to be used not only in workplaces but in various other situations. Guidelines on how to use VDTs have been published in many countries by various organizations since the 1960s. Those, however, are for specialists. Guidelines have been developed for use by nonspecialists at their own workplace. These guidelines are introduced below.

2.8 Dialogue-Style VDT Guidelines

A great deal of research has been done on chairs and VDTs, and many geometrical models have been developed of the relationships between workers and their computers in office workplaces. These models attempt, for each office worker, to specify the ideal values for predefined parameters of a workstation by processing selected physical measurements of the worker. These models are thus called “parametric models” (Noro, 1994). The physical dimensions of each worker and the dimensions of chairs, desks and appliances are all easily measured by a specialist. However, it is often “too much trouble” for the user of a chair to measure its dimensions. Therefore, it will be too difficult for a user to use these models to select the right settings of an adjustable chair to suit his/her own physical dimensions.

Noro et al. (1995) proposed a nonparametric method which does not rely on dimensions. The method is based on a database of an abundant record of measurements compiled using parametric models. It does not, however, simply present these measurements to a user so that he can adjust the dimensions to fit his own dimensions by himself. After the final set of optimum measurements is derived, the user expresses his sensation into words. The aim is to make adjustments to the chair based on the verbal values without specific reference to the resulting metric values. This sort of approach will become increasingly important as participatory ergonomics deals more and more with the general public, as will be discussed later. *A Guideline for VDT Operators* published by Waseda University in April 1995 is a VDT guideline based on this method.

The university established a VDT committee which is a team composed of eight workers, selected by the labor union as representatives of VDT users at work, and eight managers. The members of the committee were all nonspecialists. As an advisory body to this committee, a group of specialists was appointed. The guideline leaflet employs a dialogue-style approach with text such as “Which posture is the closest to your present posture?” and a procedure similar to that of a board game; the dialogue proceeds in the same manner in which a game piece moves toward its goal. Figure 2.2 shows the opening of this guideline leaflet.

Each factor from the sitting posture through the keyboard to the display adjustment is checked in a progressive order. It is a pictorial VDT guideline and when the user reaches the goal he is led to the desired posture. Figure 2.3 shows an information loop for communicating research results to individuals who are nonspecialists by converting experimental values into words.

2.9 Product Test Charter

It is difficult to measure and analyze personal information such as a person’s opinion, sensations, and feelings. In participatory ergonomics, more effort should go into developing methods to incorporate peoples’ opinions, sensations, and feelings. The product test laboratory in Sony Corp. has a “product test charter” (Noro, 1992). The following is an extract from the charter. “We shall not use any measuring instruments when we communicate with a user. We shall value the user’s feelings about the product and his/her hearing and visual senses. We shall value the user’s memory and emotional impressions. We shall test a product in an environment where the product will actually be used.” This charter is an example of the effort to enlarge the pipeline of information from the user to an enterprise and encourage the participation of the user.

Participatory ergonomics is directed toward the general public. The concept of networking is central to activities in expanded participatory ergonomics. The development of interactive technology and media that support the concept is, therefore, important. Electronic networks — namely, e-mail, the Internet and intranet — and virtual reality technology provide participatory ergonomics with powerful supportive means.

2.10 Taking Advantage of the Internet

The internet is an extremely effective tool for participatory ergonomics with the general public. Miyamoto created a home page on the Internet as a means to offer and collect information more easily and efficiently. The home page offers ergonomic knowledge regarding chairs to the Internet public and collects information to survey the situation regarding chairs by having the Internet user answer a questionnaire at the same time (Hata and Miyamoto, 1996).

2.11 Common Knowledge

There is ideally a common knowledge or tacit understanding involved in communication between workers in related fields whether the field is product development, office work, or factory work. For example, with the latest optical character recognition systems (OCRs) the tacit understanding is to use material with current commercial laser printer print quality. OCRs’ ability to read documents printed by a

1 Let's adjust the height of the chair.

The chair is strongly related to the image on the display and to various physical factors.

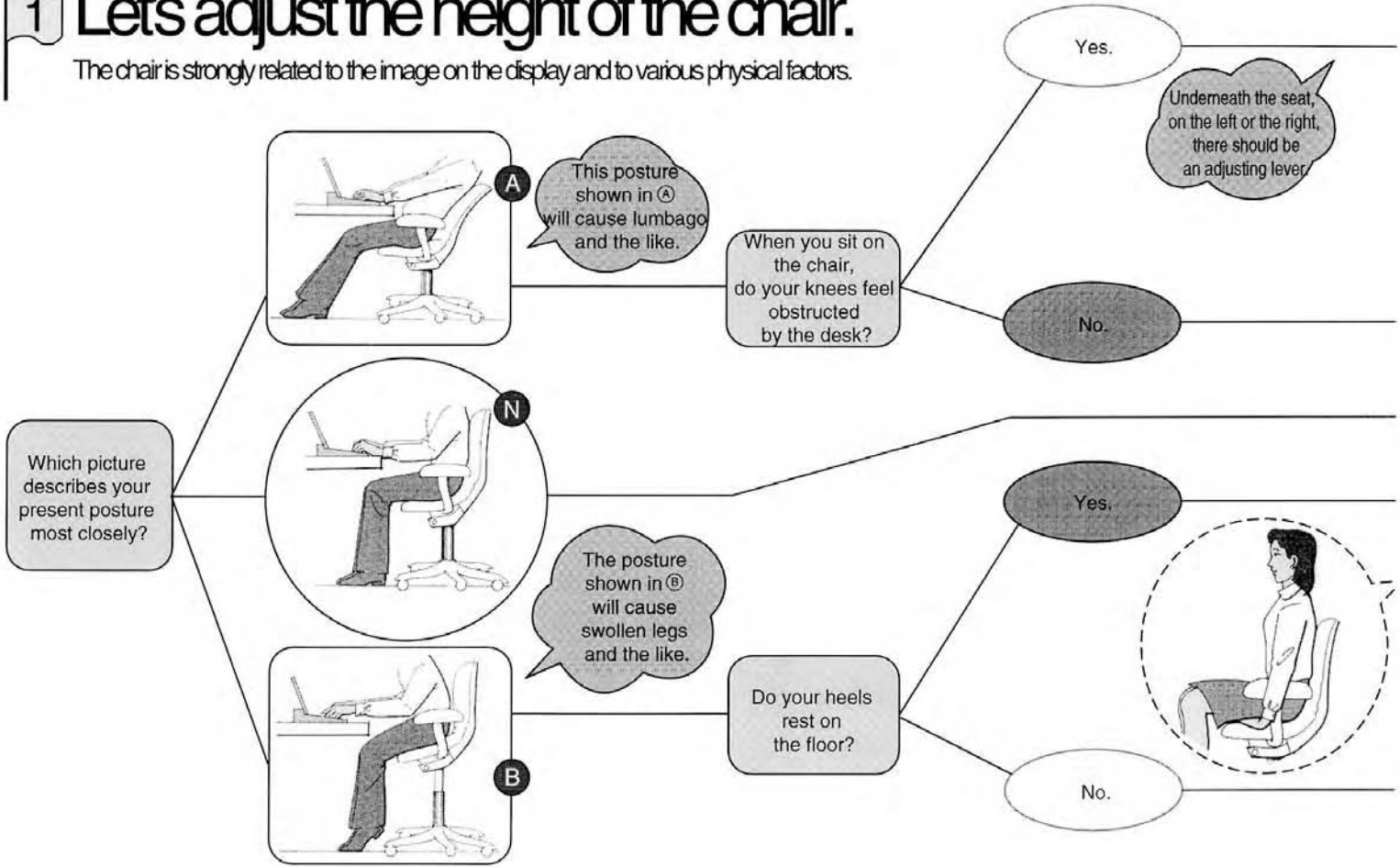

FIGURE 2.2 The opening part of the non-parametric VDT guideline.

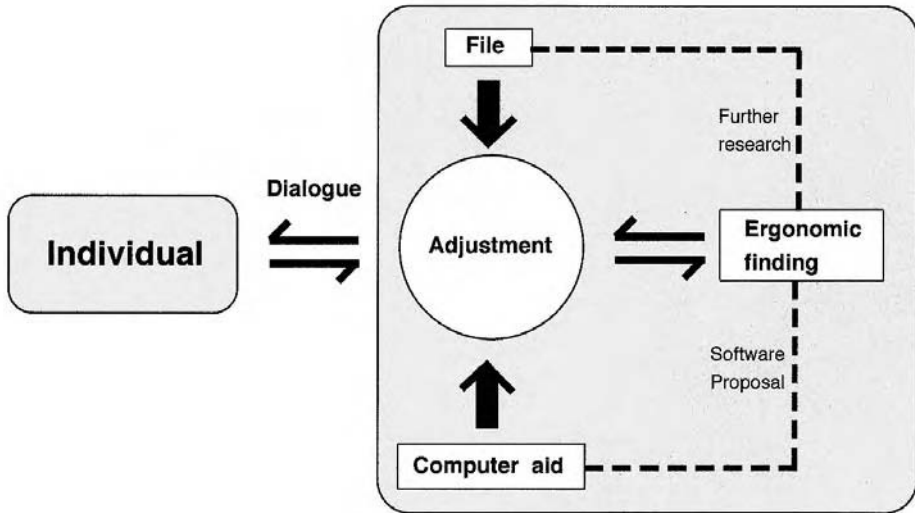

FIGURE 2.3 Information loop for making adjustments.

10-year-old dot matrix printer is drastically lower. The extent of such common knowledge is an aspect which ergonomics must clarify in the 1990s, an era of internationalization, in which countries with differing cultures communicate with each other at an unprecedented level of intensity.

Gill stated (1990) that there is, in a knowledge-based system, a limit to the art of acquisition in trying to understand active knowledge and skills. Based on the experience of conducting case studies with insurance agents and consultants, Gill points out the importance of knowledge of the tacit dimension such as a metaphor, a speaker's emotion, and cultural references that appear in conversation. This concept is called a "human mergence" by technicians who are not familiar with ergonomics (Ebukuro, 1994).

2.12 Participatory Ergonomics in Virtual Environment

Presence Communication and VR

Since the start of the 1990s the capability of computers has increased and a diverse range of peripheral equipment is employed for the user interface. The content transmitted by the interface is also changing, from a dialogue between a user and a computer to communication between many users via computers. A representative form of communication between users is the audiovisual teleconference. The conversation between users in a teleconference is, however, somewhat awkward for several reasons and the will to participate is dampened. A system in which this awkwardness is reduced and a conversation much like face-to-face conversation is possible is called "presence communication" or "telepresence" (Noro, 1996) (Figure 2.4).

Advent of a Virtual Factory

Kao Corporation is planning a "virtual factory" in which nine factories scattered throughout Japan are efficiently managed simultaneously as a single factory. Experiments have been carried out in factories in Wakayama and Kyushu and the experiments on remote control have been successful.

The larger plan is likely to be realized in the future when communication costs go down. The scope of subjects of participatory ergonomics is expanding from specified participants in a single factory or workplace to a wide variety of people across a vast area such as a whole nation, or even beyond national boundaries. In a virtual factory like this one, teamwork will be carried out as if two factories 600 km

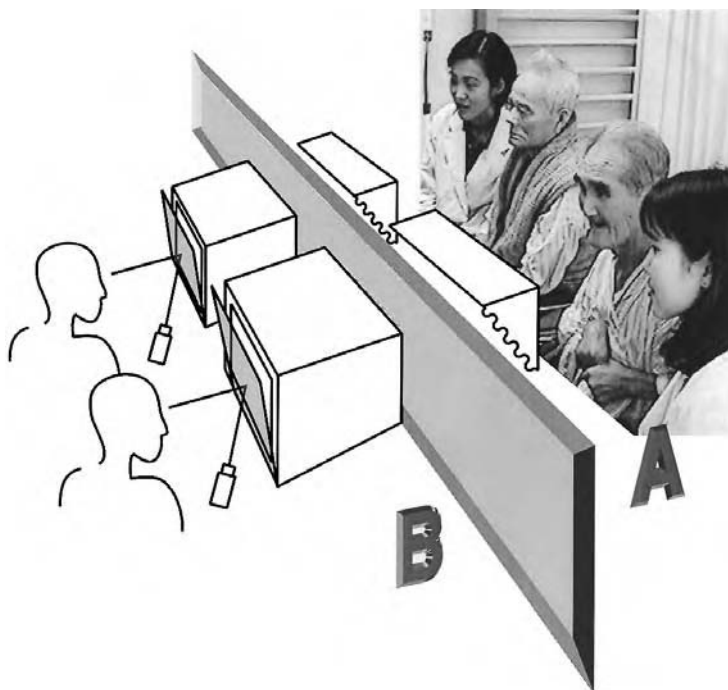

FIGURE 2.4 Presence communication network where participants exchange views. System A and system B shown here together are actually located far apart but connected.

apart were a single workplace. Presence communication will be required in order for people to participate in the teamwork.

2.13 Conclusion: Participatory Ergonomics as Future Ergonomics

Worker-Oriented Participatory Ergonomics

In participatory ergonomics, as a part of the activities of macroergonomics and organizational design and management (ODAM), the worker should be the central figure. Past reports have tended to be procedural theories or success stories from the point of view of a researcher.

The Difference between Participatory Ergonomics and Macroergonomics or ODAM

Macroergonomics and ODAM have a different concept from participatory ergonomics. It is not enough to merely treat participatory ergonomics as a part of the activities in macroergonomics or ODAM. Doing so neglects the extensive applicability of participatory ergonomics and may hinder its future development.

More Effective Methods

One of the tasks for researchers is to develop a more effective method to implement participatory ergonomics.

Activity Linking the Community, Home, and Hospitals

Participatory ergonomics is becoming an activity that extends beyond the boundary of a workplace. Home care is an example of an activity that links the community, home, and hospitals. Ergonomics should increasingly become a field where specialists and nonspecialists have an equal share.

Participatory ergonomics is evolutionary in the sense that it designs the diverse flows of information that relate to ergonomics. Electronic networks that can help to promote these flows are now becoming widespread. Participatory ergonomics should not be confined in a bulky archive of files with records of improvements made at workplaces.

Participatory ergonomics will be acknowledged by people in ergonomics-related fields as the main concept of ergonomics in the networking era.

References

- Caccamise, D. J. 1995. Implementation of a team approach to nuclear criticality and safety: The use of participatory methods in macroergonomics. *International Journal of Industrial Ergonomics* 15, 5, 397-409.
- Ebukuro, R. 1994. Macro-logical management approaches, selected paper of ICC&IE '94. *Computers Industrial Engineering* 27, 1-4, 321-326.
- Garmer, K., Dahlman, S. and Sperling, L. 1995. Ergonomic development work: Co-education as a support for user participation at a car assembly plant. A case study. *Applied Ergonomics* 26, 6, 417-423.
- Gill, S. P. 1990. A dialogical framework for participatory KBS design. *Cybernetics and Systems* 90, 1039-1046. European Meeting on Cybernetics and Systems Research (10th) Vienna.
- Hata, M. and Miyamoto, H. 1996. A home page offering ergonomic knowledge regarding chairs. Annual Kanto chapter meeting, Japan Ergonomics Society, Chiba.
- Kawano, T., Nishida, S., Hashimoto, M., Yamamoto, C., Iwata, K. and Onosato, M. 1996. Study of computer aided consultation system for working posture, using posture input puppet-like device and visualization of joint torque. *Journal of Precision Engineering Society* 62, 5, 1996.
- Kuorinka, I. and Patry, L. 1995. Participation as a means of promoting occupational health. *International Journal of Industrial Ergonomics* 15: 365-370.
- Moore, J. S. and Garg, A. 1996. Use of participatory ergonomics teams to address musculoskeletal hazards in the red meat packing industry. *American Journal of Industrial Medicine* 29 (4): 402-408.
- Noro, K. 1984. A workshop, International Conference on Occupational Ergonomics. May. Toronto.
- Noro, K. and Imada, A. 1984. A workshop on Participatory Approach of Ergonomics, Hawaii. 1st ODAM meeting.
- Noro, K. and Kogi, K. 1985. Invitation to participatory ergonomics, *Anzen* 36, 53-60.
- Noro, K. 1988. Participatory ergonomics, *Japanese Journal of Ergonomics*, 24, 5-10.
- Noro, K. 1991. Concepts, methods and people, in *Participatory Ergonomics*, Eds. Noro, K. and Imada, A. Taylor & Francis, London.
- Noro, K. 1992. Ergonomics for daily living, University of the Air.
- Noro, K. 1994. Sashaku: A user-oriented approach for sealing, in *Hard Facts About Soft Machines* Eds. R. Lueder and K. Noro. Taylor & Francis, London.
- Noro, K., Kawai, T. and Takao, H. 1996. The development of a dummy head for 3-D audiovisual recording for transmitting telepresence. *Ergonomics*, 39, II, 1381-1389.
- Vink, P., Peeters, M., Grundemann, R. W. M., Smuldrers, P. G. W., Kompier, M. A. J., and Dul, J. 1995. A participatory ergonomics approach to reduce mental and physical workload. *International Journal of Industrial Ergonomics* 15, 389-396.
- Waseda University. 1995. *A Guideline for VDT Operators*, Waseda University.

3

Tuttava: A Participatory Method to Improve Ergonomics and Safety Through Better Housekeeping

3.1	Strategies for Improving Workplaces	3-1
3.2	What Housekeeping Really Can Offer for Workplace Improvement	3-2
3.3	Tuttava — A Strategy to Initiate Workplace Improvements.....	3-4
	Organizing Tuttava • Job Analysis and the Identification of Improvement Goals • The Removal of Technical or Organizational Obstacles • Behavioral Changes	
3.4	Why It Is Important to Observe Conditions Instead of Behaviors.....	3-12
3.5	Tuttava Helped a Steel Mill Turn around the Safety Culture	3-12
3.6	Other Proven Benefits.....	3-13

Jorma Saari
University of Waterloo

3.1 Strategies for Improving Workplaces

The purpose of this chapter is to show that housekeeping, when properly understood, can be a very useful vehicle for improving workplace ergonomics and safety. This chapter will describe a process that has been used successfully in hundreds of companies and in several countries. Its primary purpose is to involve employees in analyzing and improving their jobs and workstations, and to initiate a process toward continuous improvement.

First of all, it is important to understand the nature of housekeeping properly. Materials and tools are the core of housekeeping. They also are the core of any manufacturing process. Workers handle tools and materials every day. This gives them the expertise which makes it easy for them to talk about materials and tools. Therefore, tools and materials are a very good topic for a participatory workplace improvement process.

Three groups of people may initiate workplace improvements: management, experts, and employees. In recent years, it has become more widely understood that change processes initiated by employees offer many advantages. Employees know the exact problems of work processes. They accept changes more easily if they have participated in the planning.

Several mechanisms can trigger a process toward workplace improvements. (1) Laws and regulations establish limits, such as exposure values, after which law enforcing authorities force management to take action. Standards, codes of practice, and professional rules may have similar effects. Internal inspections, audits, and monitoring systems ensure the compliance with these external norms. The problem is that, for many exposures, we do not know the limit values (Westgaard and Winkel, 1996). (2) Epidemiological studies or routine monitoring of injuries can make ergonomists, occupational health care professionals, or safety experts aware of a problem, and they then convince management to take action. This is an expert strategy. (3) Management and other professionals in the workplace initiate changes continually. The problem, however, is that both management and experts have different perceptions of problems and needs than the employees. Even when recognizing a problem, management may estimate its magnitude quite differently. In a top-down driven environment, employees initiate changes by presenting complaints, or refusing to perform a dangerous job. Complaints create an immediate negative tone for the situation, and positive solutions become less likely. (4) As employees spend all their working time at the actual place of work, they possess a lot of information on problems at work. Those problems need not be severe enough for workers to present complaints. They may, however, be sufficient to prompt ideas for better ways of getting the work done.

Employee involvement and empowerment have become more topical (Björkman, 1996). More people understand that workers have more education and training and a heightened need for the possibility of having an influence on their own working situation. Employee participation has positive effects in productivity (Doucouliagias, 1995) and satisfaction (Wagner, 1994).

Management and experts do not have enough capacity to become aware of all opportunities for improvements. Workers' observations and ideas are valuable assets in finding better ways of doing the job. The question is *how can an organization create conditions where workers share their ideas and where these ideas lead to action?* The technique I am going to describe provides an answer.

3.2 What Housekeeping Really Can Offer for Workplace Improvement

Housekeeping is a word one can find in almost every textbook on safety. It is one of those words which has been around for so long that people do not realize its full potential. "A place for everything and everything in its place" is a maxim that most managers think they have accomplished in their plant. Housekeeping is, according to textbooks, one of the cornerstones of good safety. However, the concept of housekeeping is in many texts quite narrow and relates primarily to the physical appearance of a workstation, not to the underlying processes. A guide defines housekeeping as (Stewart, 1990):

- Day-to-day clean-up
- Waste disposal
- Removal of unused materials
- Inspections to ensure that clean-up is complete

In this case, housekeeping means housecleaning. One also finds general checklists, such as the one in Table 3.1. These are often prepared for inspectors for auditing purposes. Again, the focus is often on cleanliness. The list in Table 3.1 is broader, but the view is an external auditor's view.

The traditional view emphasizes the maintenance aspect of housekeeping. Is the workplace kept in good condition? There is no doubt that this is an important aspect and that it quickly gives an auditor an overall impression of the quality of maintenance operations.

The other aspect of housekeeping, the most important one, is that *housekeeping actually reflects the quality of management and production processes* at the workplace. The flow of materials and the use of tools are in close relation to these processes. This is an aspect that is often ignored. For example, the checklist in Table 3.1 addresses this aspect with one question only: "Has excess material in-process collected around machines?"

TABLE 3.1 A Housekeeping Checklist (Ontario Meat Packers Safety Council)

-
- Are aisles clearly marked and free from stored materials, idle hand trucks, projecting piles of stock, etc.?
 - Are stairs and ramps free from wall obstructions and stored items? Are hand rails and stair treads in good repair?
 - Are suitable cleaning materials on hand to clean up spills?
 - Has excess material in-process collected around any machines?
 - Are there means for disposing of soft-drink bottles, milk cartons, lunch wrapping, etc.?
 - Has scrap been allowed to accumulate in work areas?
 - Does final disposal of scrap produce fire or other hazards?
 - Are hand and power tools properly stored when not in use?
 - Are there any tools left on machines, overhead beams, or in other locations where they could be jarred off?
 - Is there good personal housekeeping at individual workstations?
 - Are all goggles, face shields, aprons, or other personal protection equipment clean and in acceptable condition for use?
 - Are all cables, ropes, chains, slings, or other gear properly stored when not in use and regularly inspected and repaired?
 - Is all flammable material stored in fireproof receptacles with fusible links or other devices for emergency enclosure?
 - Are all warning and direction signs on machinery and elsewhere clean and legible?
 - Are the bulletin boards clean and attractive?
 - If first aid materials are kept in the department, are they sanitary, of ample supply and fresh?
 - Are there leakages, either from overhead shafting, machine packings, or elsewhere, which are causing hazards?
 - Does the department need a paint job to enhance both appearance and lighting?
 - Is oil and grease regularly removed from all machinery?
 - In wet processes, is the drainage good around machines? Are slat platforms in good condition?
 - Are windows and skylights clean and in good repair?
 - Is the exhaust equipment reasonably free from accumulated dust, lint, or soil?
 - Are lighting fixtures cleaned and up to maximum efficiency? Including emergency lighting installations?
-

The amount, the placement, and the condition of materials in a workstation are some of the most essential aspects of housekeeping, and at the same time, a visible reflection of the quality of the production process. They even reflect the overall organizational performance. Too many components in a workstation may tell us that the purchasing process does not function on time.

Materials and tools provide a window into the “heart” of the whole production system. At the same time, they are in close relation to the ergonomic demands of the workers. Therefore, focusing on materials handling offers a possibility of improving the ergonomic quality of a job and the efficiency of production simultaneously (Salminen and Saari, 1995).

Materials and tools have another nice characteristic. Both *are visible and touchable*, and therefore they are *easy starting points for discussions*. Operators do not usually know enough, for example, about a company’s purchasing process. They do see the timing when the materials are received, and this makes it possible for the operators to contribute to the analysis of purchasing processes.

Housekeeping is a visible indicator for obscured organizational conditions. In the tool department of a plant, I heard continuous complaints about not having enough room for everything; machines, work benches, parts, components, etc. The cupboards were full, neat and in good order though. The top of every cupboard was also full of materials. I told the workers that the top of a cupboard is not a good storage place for two reasons: the objects on the top will often be forgotten, and it is difficult to take anything down safely because of poor visibility.

The workers accepted these arguments but continued to complain about the lack of space. However, this apparently innocent observation and discussion revealed a major flaw in the management culture — conflicting goals. Management expected two incompatible accomplishments. They expected the tool department to remove any problems immediately and not to store so many spare parts, components, and materials. However, the delivery of items which were not in stock could take hours. During this time, production might be down which is absolutely unacceptable for management. A little visual signal led us to some of the root problems of this organization.

The observation of parts and components in inappropriate places actually unveiled organizational values more broadly than a discussion or an interview could do. Therefore, the conflicts between production and safety goals could be discussed more broadly. Materials and tools have tight connections to the management system and to the production system. Therefore, they provide an excellent starting point

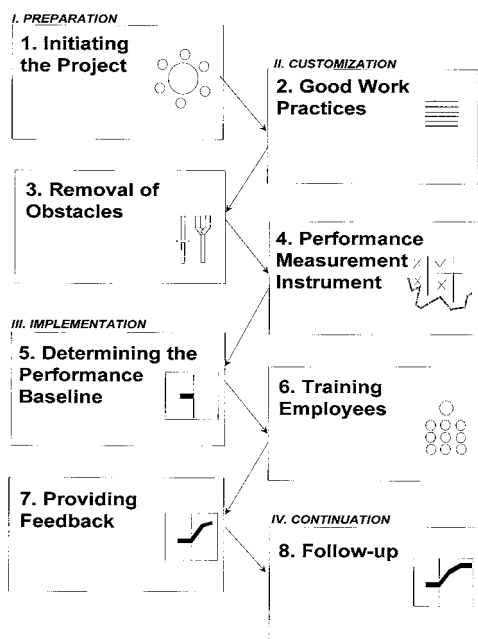

FIGURE 3.1 The steps of Tuttava.

for workplace improvement. They lead straight to systemic core issues and provide a window into the management processes.

This window is important in several ways. (1) In spite of being directly linked to the most important aspects of any production system, *tools and materials are a relatively neutral topic*. (2) It offers a manageable theme for discussions with the workers about workplace problems.

3.3 Tuttava — A Strategy to Initiate Workplace Improvements

The best strategy to initiate positive changes at a workplace is *induction by success*. It means going through several small steps that give *positive experiences* and *reinforce the desire to go further*. The experiences of success lead to more sustainable results than other strategies do. Stepwise progress leads to continuous improvements. Positive results enhance the development of management–labor relations, especially when the improvements result from joint efforts.

To this end, we developed a method and a process which focuses on tools and materials, the most important aspect of housekeeping. It is called *Tuttava*, which is an acronym coming from Finnish words which mean “*safely productive work habits*.” Tuttava is a method for initiating the change toward a better workplace (Figure 3.1). It was developed about ten years ago and it has become widely implemented in Finland (Saari and Näsänen, 1989; Saari 1996). There are also several successful applications internationally. Tuttava has the following distinctive characteristics:

- It affects all kinds of health and safety factors, including ergonomics
- It also helps improve quality and production
- It is a model for participatory improvement
- Its main principle is to keep the process positive
- Using a positive approach, it initiates small changes which then reinforce further improvements

Tuttava is a project-like method. It takes from four to twelve months to complete. The exact time depends on the participants’ previous experience with participatory methods and on the organization’s ability to adopt new directions.

Tuttava is still considered a project even if some companies have also used it as a tool for continuous performance measurement. The purpose is to introduce a permanent change which lasts without further efforts. A clear end signals the attainment of a reasonable new performance level, and thereby provides satisfaction. After the end, other techniques, such as detailed ergonomic analyses, etc. can utilize the new foundation for further improvements. Tuttava has formed a good basis for the implementation of new technologies, new production methods, etc.

Organizing Tuttava

Tuttava starts as any other workplace improvement project does. *The decision to start* is the first step. Experience shows that a company has to “mature” for the process (Harper et al., 1996). Workplace improvement must be perceived as a desirable goal. The company has to be reasonably healthy. If it has major problems, it may not be able to focus on this process, or any other process, intensively enough. Problems may be related to job security, to market, to the reengineering of the company, etc. Workplace issues seem not to be an overriding priority under such circumstances.

Tuttava is well suited to companies with poor management–labor relations. Tuttava is designed to ease problems between management and labor. Actually the best results we have obtained are in companies with rather tense relations. Otherwise the company has to be fairly healthy. Each company has a different culture which determines the roles of management and labor. In a top-down type of culture, consistent commitment and continuous support from the management are essential. The project may fail if the management gives negative reinforcement. In the case of Tuttava, middle managers and supervisors may be afraid of losing part of their power. If so, they have to be put at ease.

I have also seen situations in which employees have initiated the process without input from upper management. In a big company, the workers’ health and safety representative started the process, and the top management came onboard only when positive results were quite clear. The program became a big success in this company, and they use it permanently in their different locations. In this case, the workers’ OHS representative took the leading role. It seems to be important that there is a dedicated person who maintains the momentum. The company is multinational. It has two major locations in Finland. Tuttava has been used with great success in one location where the OHS representative took the leading role. The top management, after becoming convinced, put pressure on the second location to implement the process. In the absence of a leading person, the implementation remained superficial. The good results, however, encouraged other locations in other countries to adopt the process.

It is important to *find someone who will become the Tuttava leader*. Who this person is depends on the local culture. However, if this person’s “ownership” in the process becomes too strong, it may drive users away.

An external expert may be necessary as a neutralizer in those companies where relations are tense or where no previous experience of a similar method exists. Tense relations do not apply just to situations between management and labor. On the contrary, it seems that more often the biggest problems exist between organizational units on the same level, such as production and maintenance. Also it is often found that some individuals cannot “come along.”

Companies have used different models to organize project teams. Normally, *the project team consists of representatives from the project department, both workers and supervisors, as well as representatives from management*. OHS representatives, representatives from maintenance, occupational health services, or the personnel department sometimes supplement the core team. In other cases, all the workers belong to the implementation team. However, a smaller core team makes the preparations easier even if this is the case.

It is important that the group has access to funds or services which make technical and other corrective actions possible. The purpose of the process is to initiate all kinds of changes, new work habits, and technical/organizational improvements. When the workers improve their performance, it is only fair that the management makes funds available for technical improvements. The purpose is to initiate a comprehensive process of improvements. This is important for making the improvements visible, which then reinforces other improvements.

One team covers a work area of 5 to 30 people. We have used *Tuttava* in larger areas too. However, the effectiveness tends to deteriorate since individuals tend to lose sight of their meaning for the whole. It is easy for them to think that their contribution does not matter. The lower limit is to keep the focus on groups instead of individuals. Because the process should be positive, it should not point a finger at any individual. In a group that is too small, it is difficult to meet this requirement.

To make sure that a participatory *Tuttava* succeeds, some conditions have to be fulfilled. (1) There must be a mechanism to elect worker representatives so that the other workers accept them as their representatives (Saari, 1996). (2) Management representatives in teams must have a clear mandate from their superiors.

Especially in hierarchical organizations, a participatory program can induce unnecessary fears. If management thinks a participatory approach takes away their power, an expert-driven implementation might be more justified. The same applies in those cases when there is no way of ensuring that workers accept the worker representatives as their representatives. For example, other workers may see volunteers representing management views more than their views.

An expert-driven implementation may be more justified if the team members cannot obtain a clear mandate from their constituents. Even in this case, a team can and should be formed to advise the expert. The biggest risk in an expert approach is that the expert does not understand what is important at work and what obscured obstacles may exist to deter changes.

A participatory approach gives the best results. However, the expert approach is more advisable, if a participatory implementation team cannot make decisions as a team, and if the other workers or managers do not accept those decisions freely. An expert may have a role in the participatory approach too. In this case, the expert acts as a coach and provides the team(s) with sufficient training. In the following section, I assume that a participatory team implements the program.

Job Analysis and the Identification of Improvement Goals

The first task of the implementation team is a *job and workstation analysis*. Tools and materials are the keywords. The team makes an *inventory of good work practices for tools and materials*.

Hand tools and various work equipment are obvious tools. However, there also are tools that are used infrequently or never. Ladders, work platforms, carts, lifting appliances, etc. are examples of tools that may mostly stay in storage. Fire extinguishers and hoses, emergency exits, eyewash stations, other emergency equipment, including emergency lights and exit signs, are tools for those undesirable extreme situations easily forgotten in the daily routine. Access to this special equipment should be free, and it should be properly maintained.

In one case, an implementation team had a fire extinguisher replaced only one day before a painting box broke into flames. This was lucky timing, since the previous fire extinguisher was of the wrong type and would have only made the fire worse. The team noticed the incompatibility of the extinguisher which had been hanging on the wall of the painting area for a long time.

Typical good work practices for the use of tools are, for example, “put tools back in their designated places after use,” “clean and store tools properly,” “coil hoses and cables if not in use,” “keep access clear to fire extinguishers and other similar emergency equipment.”

Some of the following tasks are done in every workstation: receiving, storing, moving, handling, disposing, and shipping of materials. Storing is often the most essential work practice. Because of traffic requirements, some areas need to stay open all the time. Many times there are no clear rules for appropriate storage places. Typical outcomes of this discussion are: keep aisles open and other areas meant for traffic, keep the access to shelves and cupboards free, etc.

Usually, the identification of good work practices is an easy task for the implementation team. Most often, the result is nothing dramatic. Table 3.2 gives an example from a printing ink factory. The list of good work practices may not include a single new practice. However, these good work practices may not be fully in use. It is common that everybody can accept the list without hesitation.

TABLE 3.2 An Example of Good Work Practices in a Department at a Printing Ink Factory

-
1. Keep aisles open
 2. When possible, always put covers on containers to prevent solvents from evaporating into air
 3. Close bottles after use
 4. Clean and return tools after use
 5. Ground containers when moving flammable substances
 6. Use personal protector specified in the recipe
 7. Use local exhaust
 8. Store in working areas only materials and substances needed immediately
 9. Use only the designated forklift truck in the department making flexographic printing inks
 10. Label all containers
-

There may be several reasons why good work practices are not in use. Some of them may not be technically feasible. Once we studied the equipping phase of a ship. A problem was that workers brought too many materials to the ship. Many jobs were slowed down as materials blocked aisles, or materials had to be removed first. This caused extra work. It also caused unnecessary stress on the musculoskeletal system. To reduce the amount of supplies in the ship, the work practices specified “Store in the ship only materials needed for one day’s work.”

Why this ideal was not met depended on several factors. Bringing more materials to the ship was faster for the workers. The management was happy, because the workers did not go onshore so frequently. On the other hand, they were unhappy about the extra work. There were conflicting motivations, because management had never really specified the practices. In this case, the primary obstacle for good work practices was the lack of set procedures, in other words an organizational deficiency.

In another case, welding light was a problem. The company had movable curtains for preventing the light from reaching the eyes of workers nearby. It was never really thought out who should put up the curtain, the welder or the person hit by the light. Industrial engineers did not give a respective time allowance to either of the workers when setting up time standards which were the basis of wages. Another factor was that the curtains were not technically most suitable for those conditions, and they often fell down even if time was initially spent to put them up. In this case, the obstacles were both organizational and technical.

A very common example of an obstacle is the use of lifting devices. The workers often do not use lifting devices or help from another person even if technically possible. For example, nurses in hospitals lift patients alone or without a lifting device. The background factor often is that they expect their supervisors will praise them for working fast.

These kinds of problems deter the good work practices from becoming routine. The problem sometimes is technical, sometimes just the lack of agreement, or another type of organizational deficiency. Not knowing the best work practice usually is not the obstacle. These obstacles need to be identified and fixed before a permanent improvement in working habits is possible.

Good work practices should be (a) specific, (b) positive and make work easier, (c) generally acceptable, (d) simple and short statements, (e) started with action verbs, and (f) easy to observe and measure. They should give specific instructions; they should not be general warnings or bans.

Good work practices may require modifications later when the team devises a measurement system. The good work practices should be partially in use. In some parts of the application area, they may be in use all the time; in some other parts, partially or not at all. The purpose is to give a positive outset for the process of change. If all good work practices were totally new, or never in use, the process would not appreciate current achievements.

The Removal of Technical or Organizational Obstacles

Simultaneously with the drafting of good work practices, a discussion starts about possible obstacles deterring their use. It would be best if the analysis were done workstation by workstation. This way it is

TABLE 3.3 Examples from Two Departments of a Shipyard. The Percentage of Respondents Accepting After the Implementation the Statement: "Housekeeping Has Improved"

Department	Relation to the Intervention Process	Agree	Undecided	Disagree
A	Group member	100	0	0
A	Not member	57	43	0
J	Group member	72	14	14
J	Not member	35	47	25

From Saarela, K.L. 1990. An intervention program utilizing small groups. *Journal of Safety Research* 21:149-156. With permission.

possible to integrate everyone into the process. This may be essential for the acceptance of the change. Table 3.3 shows a result of an interview study after an intervention at a shipyard (Saarela, 1990). Saarela formed representative improvement groups for each department. Afterwards, the group members and other workers responded to a questionnaire about the results of the process. The group members clearly perceived more improvements than the other employees. Participation strengthens a change process.

If every workstation undergoes an analysis first, then the final list of good work practices will be combined from the individual lists. In similar workstations, often the same obstacles are discussed and more ideas for solutions may surface. The workers often have ideas they have not presented. The analysis may provide a channel for those ideas to surface.

Tuttava has been especially successful in opening development gridlock. Management is often unwilling to invest money on technical improvements, since they believe the workers will not change their work habits accordingly. Workers are unwilling to change their work habits, as management does not invest in permanent improvements. This vicious circle may continue for years.

Because Tuttava emphasizes a positive approach and stepwise progress, it has been a way to break the circle and to learn mutual trust. Therefore, it may not be essential to remove all the obstacles immediately. Sometimes, those obstacles represent major investments or changes in thinking. Then it may be wiser to do small things first and let the bigger ones follow later.

This approach proved to be highly efficient in an engineering workshop employing about 250 people (Laitinen et al., 1995). A Tuttava program leading to some permanent improvements proved to be a positive experience and provided more mutual trust. In the beginning, the management was quite reluctant to invest in technical improvements. In the late phase of the first set of departmental Tuttava projects, the management attitude changed. Especially, after the good results became visible, it was very easy to get money for technical improvements, and an intensive innovation cycle started. The whole process took two to three years.

Behavioral Changes

Theoretical Background

Tuttava does three main things. Those are: (a) the identification of goals and objectives for workplace improvements, both work habits and structural changes, (b) the identification of opportunities for improvements and using the opportunities, and (c) the change of work habits as indicated by the goals and objectives. To make the change of work habits happen, Tuttava utilizes a version of behavior modification.

Bird and Schlesinger (1970) outlined the application of behavior modification for safety. Komaki et al. (1978) and Sulzer-Azaroff (1978) published independently the first empirical applications. The idea of behavior modification is to provide more positive consequences for safe behavior. Too often, unsafe behavior leads to positive consequences and safe behavior to negative ones. Thus, people more likely choose the unsafe way of working.

The great benefit of this technique is the use of positive consequences only. Therefore, the process gets a positive flavor and the consequent changes get associated with positive factors. Another great benefit

is that very small consequences change behavior. Information about the current performance alone is enough to prompt an increase in safe behaviors.

A behavior modification program requires that (1) safe behaviors are identified and specified (good work practices in Tuttava), and (2) a measurement technique for measuring the prevalence of safe behaviors is available. The measurement technique is similar to safety sampling which was developed in the sixties (Pollina, 1962; Rees, 1967).

In behavior modification, we assume that *peoples' behavior is determined more by the consequences of the behavior than the antecedents of the behavior* (Komaki, 1986). People adopt unsafe behaviors because they expect more positive than negative consequences from those. For example, it is common that people do not use existing lifting equipment. Some of the reasons may be: (1) it is faster to lift manually, (2) the local industrial climate favors faster lifting, and rewards come from the person's supervisor or co-workers' positive comments, (3) the person's friends value strength, and manual lifting provides "free exercise," etc. Several positive consequences from unsafe lifting override the only negative consequence, low back pain. This consequence does not even materialize after each lift.

The theory of behavior modification tells us to change the balance of consequences to remove unsafe behaviors. The most desirable strategy is to introduce new positive consequences for safe behavior. More negative consequences for unsafe behavior would be another strategy. It is less desirable because the positive strategy leaves better feelings behind and these feelings may support later actions.

A wide variety of positive consequences is possible. The possibilities include various privileges (time off, extra break, etc.), tokens, promotional items, chance to win a contest (lottery, bingo, etc.), social attention, etc. Some of these are straightforward but difficult to administer. Tokens and promotional items are an example. Some are controversial — for example, social attention.

As the first empirical researchers, Komaki et al. (1978) and Sulzer-Azaroff (1978) showed that information on current performance is sufficient to alter behavior. Performance feedback has several advantages. (1) It is easy to administer. (2) It can be made objective. (3) The costs are low. (4) It is effective. Many researchers have shown that performance feedback works (for reviews see: McAfee and Winn, 1989; Sulzer-Azaroff et al., 1994). For these reasons, we decided to use performance knowledge as the new consequence for safe behavior in Tuttava. The consequences can be given to individuals or to groups. In our case, we wanted to provide the consequences to groups for enhanced group performance, in the attempt to promote team building and the cohesion of the organizational unit.

Tuttava deviates considerably from a behavior modification program. Behavior modification for safety obtains the feedback from the observation of people's behavior (Krause, 1990, 1995; McSween, 1995). In Tuttava, observations do not focus on behavior but on the traces of behavior. In other words, conditions are being observed. However, those conditions are brought about by behavior. Using conditions instead of behaviors is to depersonalize the problems in order to make the request for new behaviors easier to accept. As the purpose is to help improve management-labor relations, this supports team building and promotes cohesion. Also it is assumed that conditions lead to lasting effects (Ray et al., 1993).

Performance Measurement

To provide feedback, the implementation team writes a checklist to measure performance at any given time for providing feedback. The checklist is based on good work practices. It should consist of approximately 100 items to make the measurement accurate enough. Even with this number of observation items, the measurement is still reasonably fast. One observation round does not usually take more than 30 minutes.

Each item of the checklist has only two possible answers "correct" or "incorrect." After an observation round in the area, the observers can calculate a simple performance index, which is the percentage of "correct" items. This gives a comprehensible indicator which tells to what extent the good work practices are in use.

To devise the checklist, the team divides the implementation area into sections which form logical units. The sections can be single workstations or larger areas. The purpose of the sections (called observation areas later) is twofold. (1) They make it easy to develop the checklist. (2) They allow the use of a weighing procedure to prioritize the importance of work practices.

When the team has defined the observation areas, it writes a checklist for each area. A good work practice may generate from zero to several items into the checklist. For example, “keep the access to fire extinguishers free” generates two items in the checklist, if there are two fire extinguishers in the observation area. These items are: “Is access to fire extinguisher #1 free,” and “Is access to fire extinguisher #2 free.”

In principle, *these questions have only two possible answers: correct or incorrect.* If a fire extinguisher has been removed from the area for maintenance, then there is one more alternative, “not observable.” To limit the possible answers to two, it may be necessary to define some words. In this example, “free” may require a definition. It may be necessary to specify the area to be kept free in units of length. The need for specifications depends on the homogeneity of people’s interpretations. If everybody gives similar answers during a test, there is no need for specifications.

Some work practices yield several items for the checklist. Some work practices may not apply to all observation areas. For example, the implementation teams usually write some kind of good work practice related to aisles. Aisles may not run through every observation area. Other work practices may lead to different items. “Store tools on the tool shelves” would lead to such items as, “are there tools only on the shelves,” “are the tools in the marked places,” “are there any other objects put on the tool shelves,” etc.

Some practices are more important than others. Therefore, the team may want to generate more items relating to those. One way of achieving this is to *change the size of observation areas.* If, for example, there is a work practice related to aisles, the team can define observation areas so the number of items relating to aisles is at a maximum.

Another technique is to *use several items relating to an important practice.* A company had lots of problems because of wrong labels put on products. The first cure was to mark the place of each roll of labels on the shelves. Because this was a problem, they wanted to have an observation item for each roll of labels checking that it was in the correct place. If there were 20 rolls of labels, there would be twenty observation items, too. If the correct placement of labels had not been a big problem, they would have had one item in the checklist, checking that all rolls not in use are put back on shelves.

When we have several observation areas, it is easy to develop the full checklist. When the list for one area is ready, much of it can usually be copied to the following area. The team can produce the checklist of the next area just by removing the irrelevant items and by adding any items which did not apply to the previous area. Therefore, the number of items varies from area to area. At the same time, the items are similar in different areas, and learning to use the checklist goes fast.

Measure Baseline

When the team has the first draft of the checklist, they should test it. By comparing results and notes after the first observation round, it is easy to identify the weaknesses of the checklist. Usually, it is necessary to make several changes to the checklist. However, it is also customary that the checklist is ready for use after a couple of test rounds.

When the checklist works well enough, the team should carry out measurements for a few weeks to establish a baseline. The baseline is important, since it allows the comparison of present performance with previous performance. This makes any improvements more visible and gives more satisfaction as the difference is known.

When there is a sufficient number of baseline measurements, it is time to arrange a meeting for everyone working in the area. The team explains the best work practices, the principle of measurement, and the baseline results. During a discussion period, the attendants may express their views and opinions about needs, problems, and potential solutions in housekeeping.

Feedback

After the meeting, the team puts a feedback chart in a visible spot in the area. When observation rounds continue, the observers post the result immediately in the chart. They post only the performance index which is the percentage of items in the checklist marked correct of all items observed. This performance index applies to the whole group of people working in the feedback area. As there should be at least five people working, nobody should be able to recognize one person’s contribution to the performance index.

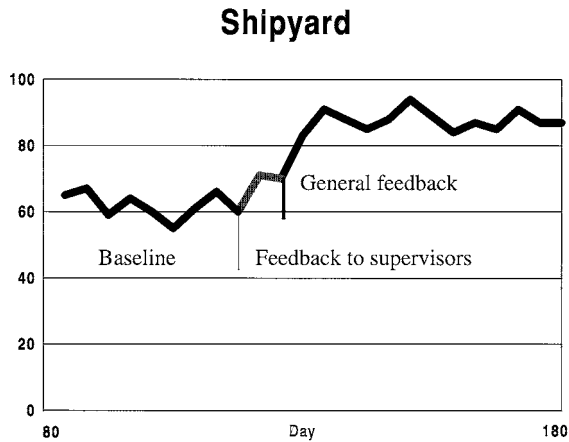

FIGURE 3.2 Performance index at a shipyard.

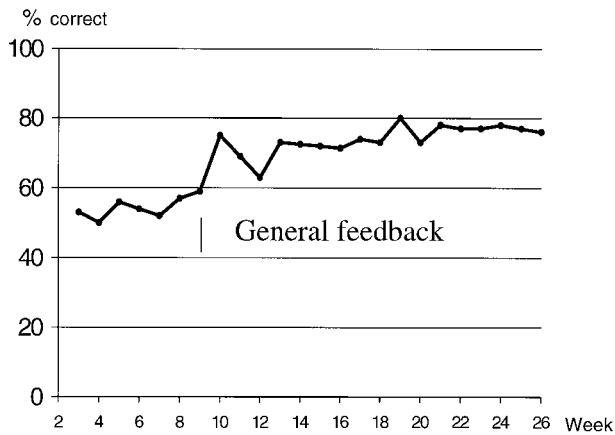

FIGURE 3.3 Performance index in a plant where improvements happened over many weeks.

The team is strongly encouraged not to release any negative information, such as detailed observation results, etc. Being positive is important in this method. Therefore, the baseline should be somewhere between 50 and 60% to give a positive starting point for further improvements. To get a suitable baseline, the teams sometimes have to modify the list of good work practices or the observation checklist during the first baseline measurements.

Any other feedback, except the chart, is usually not used. Primarily, the motivation to change behavior comes from the knowledge of positive development. It would be possible to use other rewards, but we have preferred not to.

Usually, a sufficient feedback period is from six to eight weeks. Employees adopt the new behaviors well enough during this time, and they learn to read the index from their surroundings directly. The index seems to get better quite quickly, even in a couple of weeks (Figure 3.2), and then stabilize, or it may take a period of several weeks (Figure 3.3). This depends on the number and type of obstacles deterring the use of specified good work practices.

Follow-up

When the index reaches a stable level and stays there for a few weeks, the team can terminate the feedback. In most cases, the index fluctuates a few percentage points, reflecting production conditions. It will not

be a straight line. The right time to end the feedback period is when the average of the index does not seem to change any more.

The team should conduct follow-up measurements for a few months, once a month or every second month. If a relapse happens, the team can provide more feedback or take other actions. Usually, there is no relapse. The new level has lasted as long as two years (Saari and Näsänen, 1989). Various production factors seem to change within a couple of years, making some good work practices less relevant and making the performance index obsolete. The team can start a similar project again or use other techniques.

3.4 Why It Is Important to Observe Conditions Instead of Behaviors

An important difference between *Tuttava* and behavioral safety programs utilizing feedback (e.g., Krause, 1990; McSween, 1995) is that behaviors are not observed directly in *Tuttava*. The items in the observation checklist deal only with physical and material conditions. This offers several advantages. It depersonalizes the feedback and helps avoid blaming individuals. An important advantage is that the checklist measures what anyone can see at any moment. Behaviors often last just seconds, and afterwards the connection between the performance index and the real performance is not verifiable. This way, people learn to read the feedback directly. When the team takes the feedback chart down, everybody has learned to read their performance index from the visible conditions directly.

A very important factor is that there are visible improvements if the curve goes up. Both management and labor can see that things happen. One of the common frustrations in many attempts to improve is that advancements come slowly or they cannot be seen. For example, if a company implemented a better procedure to investigate injuries and accidents, most employees might not become aware of the improvement at all.

The visibility of improvements, and the possibility to read the feedback directly without a chart are factors which make *Tuttava* results sustainable. If a safety program focuses on behaviors, it is more likely that the results will not stop after the cessation of the program (Ray et al., 1993) unless the program led into a cultural change (Geller, 1990).

Visible improvements encourage both management and labor to make new efforts. Employees become convinced that something really happens. Frustration “because nothing happens” is common in any company and in any country. Managers, on the other hand, may not believe that employees will change their behavior if they introduce technical improvements. Because they do not spend much time in the production area, they may not see the change in the actual behaviors. When the focus is in the physical conditions, they can see the change without seeing the corresponding new behavior. This helps develop mutual trust and willingness to invest in technical improvements.

3.5 *Tuttava* Helped a Steel Mill Turn Around the Safety Culture

A large steel mill in Finland with about 4000 employees, had a few fatal accidents in the late 1970s. The president of the company decided that safety must improve. He ordered his subordinates to take better care of safety. This sent a strong message to the line and the response was good, as Figure 3.4 shows. The injury rate declined quite nicely in the following years.

A problem arose when the president retired in 1984. The safety officer retired the same year, and the company lost both the strong management commitment to safety and experience in safety management. The injury rate started to rise again. The situation arose largely because, after the retirements, line managers focused on production and gave a lower priority to safety.

The president’s order had come with an unexpressed threat, “If safety in your area is not good, you as the responsible manager will face negative consequences.” Safety culture had a negative tone. The organization was forced to safety. Safety did not offer positive sentiments. When the new management took office, they did not realize how strongly they should have expressed their commitment to safety.

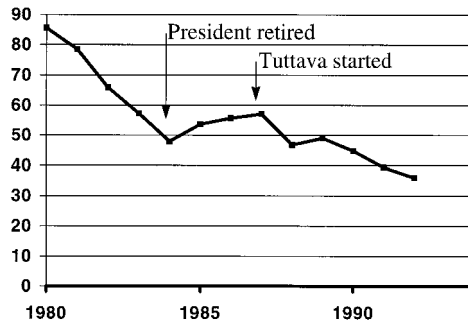

FIGURE 3.4 Injury rate at a steel mill.

The new management did not have the same political power and charisma as the retired president had. As a result, line managers reduced their work load by giving less attention to safety, which was very human and natural.

Then the new safety officer heard about Tuttava and wanted to try it. Because the steel mill was large, the implementation had to be done department by department over several years. The first year, they organized Tuttava in 10 departments, the next year in seven departments, etc. Each department formed an implementation team. The management formed a steering committee consisting of management representatives, workers' safety delegates, and representatives from the safety office. The steering committee had the political role, and it existed over the whole five years' implementation period. The departmental implementation teams had an operational role, and they existed only for the implementation period which usually lasted about six months. During the implementation period, the teams were called together four times for meetings which lasted a couple of hours. They had to report on what they had done after the previous meeting.

The results were quite remarkable. The injury rate declined by almost 50%. It is quite obvious, that Tuttava did not cause the decline directly. It served as a vehicle for a cultural change. Because Tuttava applies a positive approach and because it produces different types of benefits, it offers positive experiences for everyone. The workers benefit from better safety and easier working. The supervisors appreciate productivity and quality improvements. Other managers may see other benefits, such as the better physical appearance of the plant, etc.

Tuttava helped the different levels of management to associate a safety program with several positive improvements. Safety was not a threat but an opportunity. The implementation of Tuttava turned the safety culture around, making it possible to implement other safety processes. For example, a new safety information system requiring thorough incident investigations, safety in job descriptions, risk analyses, safety instructions for new employees, etc. was renewed or adopted. Some of these required considerable effort. The good response was possible only because the line management had more positive expectations of safety programs.

3.6 Other Proven Benefits

Tuttava is a vehicle for a cultural change, as it results in the different types of benefits. Improved safety and ergonomics are only two of those. In a company, the maintenance service department employing 300 people reported a reduction of lost time occupational injuries from 600 days to 200 days per year. In addition, the absenteeism rate fell by one percentage point which was caused by the positive psychosocial effects of Tuttava.

Another company employing 1500 people reported the release of 15,000 m² of production area, since materials, equipment, etc. were stored more rationally. The company paid 1.5 million U.S. dollars per year less in rent.

The appearance of production facilities is the first signal to a potential customer or employee about a company's functional quality. Tuttava helps improve the appearance. At the steel mill, a supervisor gave

an example. His department manufactures steel plates. Sometimes the operators walked on the plates and their shoes left clear marks on plate surfaces. The users will sandblast the plates before painting them. The marks did no real harm. However, when a customer came for a visit and saw marks left by operators' shoes "on his plates" he was dissatisfied. As a result of Tuttava, the operators stopped walking on the plates, which was also good for safety, as the risk of tripping was lower on aisles than on plates.

An engineering workshop had a high absenteeism rate. It belonged to a large corporation which had transferred some older employees there from other locations. These employees had many musculoskeletal injuries and a lowered work motivation for several reasons. The jobs of the engineering workshop were physically heavy and put employees often into awkward postures. Low motivation, previous injuries, and bad jobs were a combination which made the decision to stay at home easy.

The workshop started a several years' long project to improve ergonomics, the risk of musculoskeletal injuries, and working conditions. The relations between management and union were not very good. Management wanted to form a better partnership with the union and to encourage a participatory approach in solving problems. The core of their strategy was to improve relations first by implementing Tuttava department by department. This was aimed to produce some visible changes and to reduce peoples' frustrations from some previous projects. Tuttava achieved this goal. Previous common mistrust started to ease. Visible improvements encouraged more demanding ergonomic innovations. Finally, all the departments invented and implemented a large number of ergonomic improvements, psychosocial working conditions became much better, and absenteeism started declining (Laitinen et al.).

The ultimate factor often seems to be *the need for a cultural change which makes ergonomics and safety positive and more desirable*. Change strategies emphasizing legislation and regulations easily lead to negative sentiments about safety and ergonomics. "You have to" mentality is not appealing to many managers. Therefore, Tuttava has been a successful tool, as it is a way to initiate a change process toward a more positive safety culture. Housekeeping, especially materials and tools is a good theme for the process, since they are in direct relation to the core factors of any production system.

References

- Bird, Jr., F.E. and Schlesinger, L.E. 1970. Safe-behavior reinforcement. *ASSE Journal* 15(June): 16-24.
- Björkman, T. 1996. The rationalization movement in perspective and some ergonomics implications. *Applied Ergonomics* 27: 111-117.
- Doucouliaos, C. 1995. Worker participation and productivity in labor-managed and participatory capitalist firms: A meta analysis. *Industrial & Labor Relations* 49:52.
- Geller, E.S. 1990. Performance management and occupational safety: start with a safety belt program. *Journal of Organizational Behavior Management* 11(1):149-174.
- Harper, A., deKler, N., Osborne, D., Robinson, L., Cordery, J., Sevastos, P., Gunson, C., Sutherland, M. and Colquhoun, J. 1996. Effectiveness of behavior based safety — the Curtin industrial injury trial, in *The Proceedings of 1996 Occupational Injury Symposium*, February 24-27, 1996, Sydney, Australia, 73.
- Hog dressing safety and health guide. *Ontario Meat Packers Safety Council/IAPA*, 29-30. Toronto, Ontario TS200, 781.
- Janssens, M., Brett, J.M. and Smith, F.J. 1995. Confirmatory cross-cultural research: Testing the viability of corporation-wide safety policy. *Academy of Management Journal* 32: 364-382.
- Komaki, J., Barwick, K.D. and Scott, L.R. 1978. A behavioral approach to occupational safety: pinpointing and reinforcing safe performance in a food manufacturing plant. *Journal of Applied Psychology* 63(4):434-445.
- Komaki, J. 1986. Promoting job safety and accident prevention, in *Health and Industry, A Behavioral Medicine Perspective*, Eds. M.F. Cataldo and T.J Coates, 301-319. John Wiley & Sons, New York.
- Krause, T.R., Hidley, J.H. and Hodson, S.J. 1990. *The Behavior-Based Safety Process*. Van Nostrand Reinhold, New York.
- Krause, T.R. 1995. *Employee-Driven Systems for Safety*. Van Nostrand Reinhold, New York.

- Laitinen, H., Kivistö, M., Kuusela, J., Rasa, P.L. and Saari, J. 1995. Removing the cultural obstacles to better ergonomics with behavior modification programme, in *Second International Conference on Prevention of Work-Related Musculoskeletal Disorders*. IRRST, Montréal, 495-494.
- Laitinen, H., Saari, J. and Kuusela J. 1997. Initiating effective change process for improved working conditions and ergonomics with participation and performance feedback: A case study in an engineering workshop. *International Journal of Industrial Ergonomics* 19(4):299-305.
- McAfee, R.B. and Winn, A.R. 1989. The use of incentives/feedback to enhance workplace safety: A critique of the literature. *Journal of Safety Research* 20(1):7-19.
- McSween, T. 1995. *The Values-Based Safety Process*. Van Nostrand Reinhold, New York.
- Pollina, V. 1962. Safety sampling. *Journal of the American Society of Safety Engineers* 7(8):19-22.
- Ray, P.S., Purswell, J.L. and Bowen, D. 1993. Behavioral safety program: Creating a new corporate culture International. *International Journal of Industrial Ergonomics* 12:193-198.
- Rees, A.G. 1967. Safety sampling — a technique for measuring accident potential. *The British Journal of Occupational Safety* 7(79):190-195.
- Saarela, K.L. 1990. An intervention program utilizing small groups. *Journal of Safety Research* 21:149-156.
- Saari, J. and Näsänen, M. 1989. The effect of positive feedback on industrial housekeeping and accidents; a long-term study at a shipyard. *International Journal of Industrial Ergonomics* 4:201-211.
- Saari, J. 1996. Participatory workplace improvement process, in Stellman, J.M. (Ed.) *Encyclopedia of Occupational Health and Safety*, 4th edition, International Labour Office, Geneva 1997. 59.11-59.15.
- Saari, J. 1996. Use of a safety program in two different organizational cultures. *CybErg* 96, <http://www.curtin.edu.au/conference/cyberg/>.
- Salminen, S. and Saari, J. 1995. Measures to improve safety and productivity simultaneously. *International Journal of Industrial Ergonomics* 15:261-269.
- Sulzer-Azaroff, B. 1978. Behavioral ecology and accident prevention. *Journal of Organizational Behavior Management* 2:11-44.
- Sulzer-Azaroff, B., Harris, T.C. and McCann, K.B. 1994. Beyond training: organizational performance management techniques. *Occupational Medicine: State of the Art Reviews* 9(2): 321-339.
- Stewart, K. 1990. *Guide to Workplace Housekeeping*. Canadian Centre for occupational Health and Safety, Hamilton.
- Westgaard, R.H. and Winkel, J. 1996. Guidelines for occupational musculoskeletal load as a basis for intervention: a critical review. *Applied Ergonomics* 79-88.
- Wagner III, J.A. 1994. Participation's effects on performance and satisfaction: a reconsideration of research evidence. *Academy of Management Review* 19(2):312-330.

4

Quality and Ergonomics: Application of Ergonomics to Continuous Improvement Is Integral to the Goals of Business

4.1	Introduction	4-1
4.2	Human Element Links Clearly to Continuous Improvement.....	4-2
4.3	Organizational Process Orientation	4-3
	Organizational Processes • Process Focus • Organizational Structure and Processes	
4.4	Utilizing Ergonomic Precepts to Design Processes	4-5
	A Major Element for Achieving Quality • The Goals of Early Involvement to Achieve Quality • Basic Human Capabilities and Capacities • Application of Ergonomic Precepts to Processes	
4.5	Method of Developing Ergonomic-Oriented Processes	4-8
	Step One — Training • Step Two — Task Analysis • Step Three — Human Capability • Step Four — Perceptual Queues • Step Five — Potential Assistance • Step Six — Task Assignment • Step Seven — Simulation • Step Eight — Modification	
4.6	Measuring Results	4-12
	Unique Contribution of Ergonomics to Design Activity and to Company Processes • Value Added to Design Activity and to Company Processes	
4.7	Conclusion.....	4-13

Robert L. Getty

*Lockheed Martin Tactical Aircraft
Systems*

4.1 Introduction

A holistic view is essential for quality initiatives such as Total Quality Management (TQM), ISO 9000, Concurrent Engineering, Business Reengineering, and Business Process Improvement. The challenge is knowing how to transition from this theoretical concept to implementation. The relationship between quality interest and an ergonomics program will be the focus. An ergonomics-oriented safety improvement program includes (1) ergonomics or fitting the job to the person, (2) integration of operations management, safety engineering, medical management, and employees as co-owners of the process, (3) the

emphasis of ergonomic precepts in the engineering of new processes and improvement of current processes, and (4) the emphasis of employees taking responsibility for their own well-being and the improvement of their work environment. The parallel between the continuous improvement process delineated by the quality-system requirements in ANSI/ASQC Q9001-1994 and the improvement contributions of ergonomics is very revealing (Getty, Abbott, and Getty, 1995). It is the contention of this approach that if the precepts of ergonomics were applied to the work environment, it would support the objective of world-class quality and productivity, resulting in improved global competitiveness of businesses.

When improving processes for TQM or continuous improvement, the focus is on how to improve the process in order to achieve a quality product or service. In contrast, the focus in ergonomics is on how to improve the process to make it more compatible with the person performing the process or task by fitting the job to the individual. From the ergonomics approach, the question of the worker is how we can improve the process to make this task easier, more comfortable, and more satisfying. This approach, because of its intuitive nature and easy identification, achieves the very objective that the conceptual approach of TQM or continuous process improvement may not. The focus on people involved with work processes, as well as the administration of meeting their needs, clearly indicates the requirement for integration of all facets of these processes. The physical demands of work and the identification of ergonomic hazards or physical stressors (1) define the treatment that medical professionals prescribe for the injured employee, (2) describe those areas that are incompatible with the worker's physical or cognitive capability, and thus (3) reveal areas needing improvement, (4) provide useful tools for management in assignment of work that will reduce the risk potential and gain efficiency, and finally (5) portray, to designers of new processes, techniques to gain quality, productivity, and safety objectives (Getty, 1994).

The approach of ISO 9000/ANSI/ASQC Q9000 emphasizes the mechanisms needed to create a continuous improvement environment and then an audit process to verify the effectiveness of such an environment. This model could be very useful for an ergonomics process that must fit the requirements of both large and small companies. It may encourage large companies to aid the ergonomic development of tools, packaging, and processes that are purchased from suppliers.

4.2 Human Element Links Clearly to Continuous Improvement

Sparks and Dorris (1990) are scholars and practitioners in the fields of organizational behavior/development and industrial psychology and have written much about organizational change. Their work focuses on individuals, groups, the macro organization — or alternatively, systems — and on the management of change in people in organizations. A model is necessary that incorporates the issues of human behavior, the concerns for improved functional performances within organizations, the need to improve quality and productivity in the workplace, and the need to manage change within institutions and organizations. TEAMS (Training for Excellence in American Manufacturing and Services, Inc.) has developed a model which provides a conceptual basis for transforming an organization from one that manages for short-term profits into a productive, forward-looking, competitive business. The goal of continuous improvement of productivity through quality is at the heart of the model which is derived by blending several theories and methods. Continuous quality improvement has as its underlying philosophy the works of Deming, Juran, Taguchi, Tribus, and Crosby. Leadership, people, method, and strategy are essential for realizing the focus, achieving the goal, and putting the philosophy into action. Of the three current philosophies — defect detection, defect prevention, and continuous improvement — continuous improvement is the most advanced relative to seeking to control products or services that are defective or of lower quality than desired. Continuous improvement suggests that improving the production system is a never-ending process.

Hatch (1993) developed a cultural dynamics model showing how the processes of manifestation, realization, symbolization, and interpretation provide a framework for discussing the dynamism of organizational cultures. Van Donk and Sanders (1993) found it is possible to improve quality management

and its implementation through the study of organizational culture. Goldberg (1992) suggested that classic change management techniques are no longer adequate because change is occurring at a much faster pace. According to classic theory, change management requires several steps, specifically, unfreezing the organization's existing culture, creating cognitive recognition to open the workforce to what is new, and refreezing the culture once the change has been accepted. Today's new framework for change, the Static stage, also calls for the unfreezing of the current organizational culture. In the Fluid stage, employees begin to understand the changes that will benefit them as well as the organization. In the final stage — the Dynamic stage — people work with the new processes and await the next change that will be made. The implementation involves opening channels of communication, creating visionaries and change agents, developing a learning environment, providing training, and establishing a team approach.

Ergonomics provides the method to maintain quality systems that produce quality products. Designing quality into production or service processes can best be achieved by considering the capabilities and capacities of human performance. All processes in both service and manufacturing industries are completely dependent on effectively meeting the needs of those performing the tasks. Assessing those needs and designing processes that satisfy them enhance the talents of the worker. Manufacturing processes often are more clearly descriptive of the process improvement methods, since the idea of value added to the product at each process is more intuitive. However, from an ergonomic perspective, the processes within the service industries more clearly depict the human input to the development and delivery of the service. When the human impact of developing a service is neglected, then the individual's needs are not met and the input to the development of the service suffers. The end result is a dissatisfied or excessively fatigued worker who is incapable of adding sufficiently to the service for it to meet the needs of the customer (Getty and Getty, 1994).

The goals for improving processes to achieve better quality can best be realized by integrating and applying ergonomic precepts so that those carrying out the process are accommodated. The definitions of the inputs for early involvement in process design can be best formulated through ergonomics. When the total organizational culture and structural elements are considered, then individual roles will have stronger and more meaningful input. Those who perform, manage, and interact with the operational processes are the experts in process improvement. The application of the ergonomics principles provides the means to design quality processes (Getty and Getty, 1994).

The human element and the culture of the organization are a common thread in continuous improvement initiatives (Getty, 1996). Considering these human elements is the foundation for human factors engineering of the workplace, which is also known as ergonomics. There are numerous resources available to organizations to initiate an improvement process that addresses quality, productivity, and safety. The essential resource for bringing it all together resides within the organization (Getty, 1992b).

The improvement change process occurs when management commitment and action coincide, as well as when employee self-interest and quality goals are in agreement. When the management and employee roles are addressed together through principles of ergonomics, clearer understanding of needs and steps to solve them are realized. The process of developing a continuous improvement program must be an integrated approach. Many resources are available from various experts residing in multiple areas of the company as well as in many professional societies. Both research and the experience of ergonomics practice clearly show the necessity for holistic thinking and willingness to look beyond one's immediate capability and resources to achieve continuous improvement.

4.3 Organizational Process Orientation

Organizations are made up of processes and streams of processes (Conti, 1993). Processes are entities in an organization over which a manager has complete visibility and effective control from inputs to outputs. When organizational boundaries occur and more processes are present, then there are multiple processes or streams of processes. This concept taken together with the structure and culture of an organization can provide focus for those in the structure to be instrumental in the change process. Each process owner

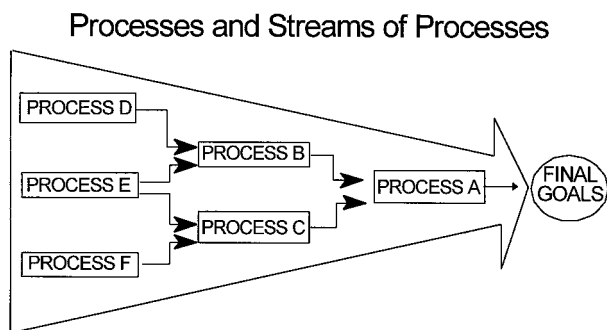

FIGURE 4.1 Processes are not clearly defined. Process owners must be properly reoriented. (From Getty, R. L., Cost justification of ergonomics improvements. In O. Brown and H. W. Hendrick (Eds.) *Human Factors in Organizational Design and Management - V*, (1996), pages 417 to 420, with kind permission from Elsevier Science - NL, Sara Burgerhartstraat 25, 10055 KV Amsterdam, The Netherlands.)

with the proper orientation and knowledge of available tools can become the mechanism for change for that process (Getty, 1992a).

In the industrial setting with so many demands for meeting individual and organizational objectives, there are not enough resources to successfully pursue all the improvement changes plus an ergonomics program at the same time. Frequently, ergonomists or others promoting improvement to company processes focus only on their program. In the enthusiasm of making improvements, the tools such as ergonomics seem to be more important than the processes of the company. Furthermore, when work demands are high, there is little time to support the extra effort of improvement programs. Even though these programs have goals that will improve company processes in the long run, the short-term urgency of getting a product out the door takes precedence. The key to achieving improvement is to blend together work processes with the improvement effort. Improvement cannot be an add-on to normal process work, but must be one and the same. Tools for improvement, including ergonomics, do not produce the products, the processes do. In the area of ergonomics cost justification, there must be clear improvement to processes since this is the foundation for the central purpose of the company.

Organizational Processes

An organization consists of processes and streams of processes (Figure 4.1). In order for the organization to accomplish its purposes, various processes are present. Frequently, these processes are not clearly defined, and an initial step to properly orient process owners for change is for them to become aware of the organization from this perspective. The processes are the focus of the behavioral groups and provide cohesiveness.

Process Focus

Processes provide the focus for establishing the individual process goals that are derived from the overall organizational goal (Figure 4.2). In order for change to occur, there must be clear relevance to the goals of the processes. An important step, once the behavioral and process aspects are recognized and understood, is to delineate how individual goals contribute to the organizational goals. Once this occurs, there is purpose provided to initiate change. The strength of the desire to change and improve is directly correlated to how well the processes are meeting their goals. It may well be that there must be an evaluation of how well goals are being met before any suggestion for change can occur.

Organizational Structure and Processes

The organizational structure relates to the organizational processes (Figure 4.3). Often in the change endeavor, the first attention is given to a criticism of the organizational structure. That structure has

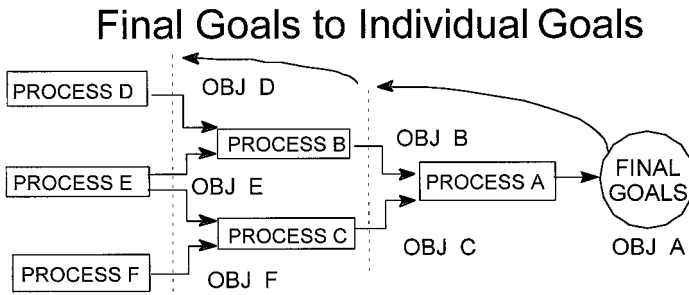

FIGURE 4.2 Processes provide the focus for establishing the individual process goals that are derived from the overall organizational goal. (From Getty, R. L., Cost justification of ergonomics improvements. In O. Brown and H. W. Hendrick (Eds.) *Human Factors in Organizational Design and Management - V*, (1996), pages 417 to 420, with kind permission from Elsevier Science - NL, Sara Burgerhartstraat 25, 10055 KV Amsterdam, The Netherlands.)

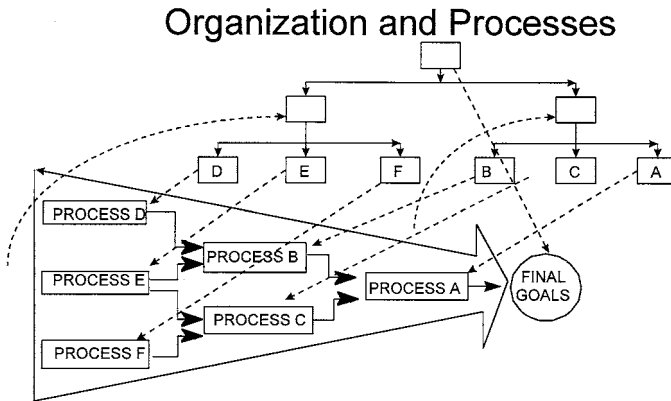

FIGURE 4.3 The structure of an organization seems to depict that the goals of lower levels are to satisfy those assigned to upper levels. The view of processes and streams of processes changes the focus to the demands of the next process. (From Getty, R. L., Cost justification of ergonomics improvements. In O. Brown and H. W. Hendrick (Eds.) *Human Factors in Organizational Design and Management - V*, (1996), pages 417 to 420, with kind permission from Elsevier Science - NL, Sara Burgerhartstraat 25, 10055 KV Amsterdam, The Netherlands.)

been derived over time and may be a major part of the organization’s culture. The structure initially must be identified to the processes that accomplish the organization’s purpose. Due to the way the structure of an organization is depicted, it appears that the goals of lower levels are to satisfy the requirements of those assigned to upper levels. Once one considers processes and streams of processes, the focus is to meet the demands of the next process. If there are difficulties in meeting the next process demands, then the management level responsible for the stream of processes becomes involved.

4.4 Utilizing Ergonomic Precepts to Design Processes

A Major Element for Achieving Quality

Ergonomic precepts address human physical and cognitive skills. When applied to process development, quality is significantly improved. These essentials are presented for service and manufacturing industries. A model is presented for the initial design of processes or for review of existing processes.

The goal of quality is to meet requirements 100% — zero defects (Cosby, 1979). To prevent quality problems, human skills need to be matched to processes. In addition, according to the principles of concurrent engineering, all previously downstream activities should be part of the design process. For

this activity to be effective, the total picture of the human involvement throughout production or service processes must be clearly described. However, the human factors element of process design is often considered a mere given or an automatic feature of people involved in the process. It is true that many of the ergonomic concepts are intuitive; they describe what people know they can and cannot do. Yet, there are specific laws, rules, or precepts that must be followed to attain productivity, quality, and safety goals. These precepts refer to the basic human capabilities and capacities exhibited in the workplace. These goals can only be achieved by soliciting input from process operators. Otherwise, the process methods become a management-only decision, and individual productivity is stifled.

This discussion will present the application requirements of ergonomic precepts to process design. A review of human capabilities will illustrate all aspects of the skills that must be considered. Both production and service processes will be discussed to show the relationships to the human element. Finally, a model will be presented to be followed for the initial design of processes or review of existing processes. The best aspect of this approach is that any individual can be an ergonomic practitioner, with a thorough orientation to ergonomic precepts coupled with experience, to provide the necessary input to realize the benefits of applying these principles. At the same time, these precepts must be followed or all the technical process development and analysis will be deficient and flawed when they are executed.

The Goals of Early Involvement to Achieve Quality

Research and development (R&D) must be aware of the manufacturing commitment of uninterrupted output and the anxiety caused by retraining of skills, new status, and communication patterns (Steele, 1989). Consequently, manufacturing people must be involved in technology development. In order to achieve producibility and productivity, designers must be aware of all the elements of the manufacturing processes and effectively utilize all resources and talents (Stephanou and Spiegl, 1992). In addition, future factories will require that all the human elements (both social and physical) as well as economic and technological aspects be addressed. The way the Japanese moved from mass production to their current manufacturing approach is discussed in *The Machine that Changed the World* (Womack, Jones, and Roos, 1990). The authors indicated that the Japanese could not afford to invest in mass-producing machinery to the same extent that the United States did. Consequently, *people* became more important. They added that when the companies agreed to provide life-time employment, the employee was expected to perform whatever tasks were necessary and contribute expertise to improvement. "So it made sense to continuously enhance the worker's skills and to gain the benefit of their knowledge and experience as well as their brawn" (Womack, Jones, and Roos, p. 55). This last statement is probably the key to the Japanese success story. Although life-time employment cannot always be provided in the present Japanese economy, this role of the individual worker continues to be sustained, and the Japanese are able to maintain their competitive position. If other world economies genuinely accepted input from the worker with equal importance as any management activity or technical innovation, the goals of quality, productivity and safety would be realized. Ergonomic precepts provide the tools for such involvement.

Basic Human Capabilities and Capacities

It is obvious that the human element must be considered when designs are developed. Without awareness of human capabilities, the impact of the human role is not sufficiently evaluated. Designers underestimate variability and its importance in industry (Garrigou, 1991). Ergonomists should, in addition to contributing their knowledge, "create design situations which enable the use of operators' and designers' knowledge and their confrontation in order to establish forecasts of future work situations concerning health and efficiency criteria in order to transform them" (Garrigou, 1991, p. 1666). The focus of this "confrontation" should be work activity and not technology. Some work activity topics include: succession of operations, processing of information by the operator, physical strain (efforts, posture), and exposures to environmental factors. These discussions would lead to the evaluation of processes in terms of health and efficiency. This, in turn, would lead to modification and improvement.

Much of this discussion may appear to be simply “doing the right thing,” but failing to account for ergonomics is antagonistic to the business goals of productivity, quality, and safety. Any change that takes ergonomics into account will cost money but should lead to reduced injury and cost, as well as improve efficiency (Alexander, 1986). Ideally, there should be ways of predicting benefits and developing and implementing workable recommendations. It is important to note that there are both tangible, business reasons for changes, and intangible benefits to the worker. Alexander states, “One must learn to distinguish between value and the ability to measure. In some cases, the value is there but it is just not worth much to develop the quantitative measures necessary to prove it” (1986, p. 4). Those involved in reviewing causes for quality defects, missed production rates, or dissatisfied customers can relate to a need to fix the obvious cause rather than spending extensive amounts of time pondering all the possible causes.

Many, when determining the area that ergonomics or human engineering covers, may focus only on a single element such as physical aspects. Ergonomic principles cover *all* aspects of human skills. Alexander (1986) explains that industrial ergonomics problems should be characterized according to the type of body system that is affected. These body systems include: (1) Physical Size: Anthropometric, (2) Endurance: Cardiovascular, (3) Strength: Biomechanical, (4) Manipulative: Kinesiology, (5) Environmental: External, and (6) Cognitive: Thought. These systems should be considered as engineering principles to be followed, not soft, optional choices that are weighed against other factors. Once ergonomic precepts are made part of the design process, a new awareness of human capabilities and limitations emerges and the desired outcome of the processes is achieved.

Application of Ergonomic Precepts to Processes

Service Processes

There are a number of essential aspects to be considered in the design of service operations (Armistead, 1985). Elements of service processes include: (1) The interaction of the customer, either as the only receiver of the service or as integrally involved with the service delivery, (2) the behind-the-scene (back room) activities to produce the service, (3) the visible interface with the customer (front office) activities to deliver the service, (4) the different focus of the customer who may desire only parts of the same service, and (5) the simultaneous production and consumption of services to be delivered.

The need for input of the human service worker becomes apparent throughout these elements. Service delivery is very labor intensive. People skills are of greater importance than technological capability. Understanding the intangibility of the service processes can be assisted by evaluating the role of human delivery and by role-playing the customer’s participation. Although the skill levels of the service provider vary enormously from a doctor to a cashier, the human capability is the major factor in the delivery of services. Some service processes that develop in the back room actually resemble much of the processes found in production industries. However, task analysis of service processes has an additional dimension of customer interface. The quality of this encounter is unpredictable. To improve the process, the expertise of service delivery personnel and customers should be included in the design of service processes. This utilization of ergonomic precepts enhances the service delivery personnel/customer interface and produces processes that result in satisfied customers.

Production/Manufacturing Processes

Edosomwan (1989), in his discussion of rules to follow for emerging technology suggests, “The designer must combine and use interdisciplinary knowledge to understand all issues involved in the interface between man and technology” (p. 43). He sees four phases: (1) information gathering, (2) planning, assessment, and measurement, (3) selection, and (4) testing and evaluation. He feels that designers, manufacturers and potential users of technology should be involved throughout the design processes.

As production processes are designed and developed, the impact of workers and their supervisors should be evaluated by actually running a simulation and having the affected workers assess the effects. The cost associated with “make-it-work” changes has traditionally been a major part of manufacturing process development. These changes have often been considered part of the business cost of developing

new technology. However, hidden in these costs are the quality and productivity costs that are not always apparent during the design phases. Further removed from the design arena are costs that are impacted by repeated exposure to manufacturing processes that fail to take into account human capability and capacity. These processes, over a period of time, cause cumulative trauma injuries. Costs associated with injuries are high and so are the costs due to poor quality and productivity. Human errors caused by process designs that exceed human cognitive skills lead workers into a vicious cycle of repeated injury, inefficiency, and quality problems. To break the cycle, involve the worker in evaluating the processes, and many of these effects will be avoided. The production worker may have a simple input such as, “the task is uncomfortable,” or, “is hard to understand.” These inputs boldly signal the need for change.

4.5 Method of Developing Ergonomic-Oriented Processes

The precepts of ergonomics are frequently taken for granted and not given adequate attention in the design process. This may be due to a large extent to their intuitive nature. However, this characteristic of ergonomic principles makes them easy to apply. Imada (1991) discusses that the application of ergonomics precepts should be participatory, and noted three reasons for involving people in the design process: (1) Ergonomics is intuitive from workers’ experience; (2) ownership enhances implementation; and (3) end-user participation causes flexible problem-solving.

Resources for change exist *within* the organization and any attempt to hand this activity over to others greatly dilutes the effort (Getty and Getty, 1993). Liker and Joseph (1986) suggest most companies do well to use their in-house personnel as the source for analyzing and redesigning jobs. This capability to be “ergonomic practitioners” comes from their experience and the knowledge that was gained in brief ergonomic training sessions. It has been shown that those with greater industrial experience within their own company are better able to identify ergonomic stresses than outsiders with academic background oriented to factory operations. Traditionally, companies call in consultants. However, this practice causes dependency and does not recognize the worker as a valuable resource (Imada, 1991).

Successful adherence to ergonomic precepts involves utilizing the expertise that is most closely familiar with the operational processes. A model for applying ergonomic precepts is portrayed in steps one through eight below. Tables 4.1 through 4.8 provide check sheets for each respective step. The elements in this model are similar to any evaluation of processes for improvement. The emphasis in this model is the human element. It takes those involved in the process design through a series of steps that begins with training and carries them through the development of an ergonomically sound process. Ergonomics then becomes a methodology for learning required skills, utilizing human capability in process design, and performing root cause analysis in order to take corrective action and improve processes. The ergonomic-oriented individual who is familiar with the manufacturing and service processes is the most capable one to apply this model, since this person views work situations from the “eye” of the worker.

Step One — Training

Training of those involved in company processes must occur first. Training does not take place just because classes are held. Before any training can take place, the need to learn must be established. This need can take place by developing an awareness of what can be better than the existing condition. This can take the form of learning what other similar groups have attained or that the current safety, productivity, quality, or service delivery is deficient. The next aspect of awareness is that those involved in the processes are the best resource for identifying the solutions. In the safety arena, describing the potential for working without pain develops motivation for improvement. When considering productivity, the awareness of how the individual shares in the success of the company creates motivation. In order to improve service delivery, the awareness of how the customer and the service provider have common interests reveals the need for improvement. According to Getty (1993), the closer the service provider is to the customer, the higher the perception of service quality. Training topics must provide the participants with the tools, the awareness of the work environment, and a clear understanding of their individual roles of improving the processes through the use of ergonomic precepts.

TABLE 4.1 Train

TRAINEES
Those Familiar with Process — Operators. Engineers — Process/Product Designers. Management — Process Supervisors.
SUBJECTS
Ergonomics Awareness. Human Systems. Methods of Collecting Data. Specific Organization's Plan for Ergonomics Improvement. Identify Tools and Resources such as guidebooks and checklists.

From Getty, R. L and Getty, J. M., Significance of approaching participatory ergonomics from the macroergonomics perspective: A continuous improvement process. In F. Aghazadeh (Ed.) *Advances in Industrial Ergonomics and Safety VI*, (1994) pages 182 to 186 and Figure 1, with kind permission from Taylor & Francis, 1 Gunpowder Square, London.

TABLE 4.2 Task Analysis

Review Areas with Highest Productivity, Quality or Injury Problems. Incorporate in Development of New Process. Review Flow of Processes. Define Inputs and Outputs of Process Increments. Determine Interfaces: Man–Machine–Customer
--

From Getty, R. L and Getty, J. M., Significance of approaching participatory ergonomics from the macroergonomics perspective: A continuous improvement process. In F. Aghazadeh (Ed.) *Advances in Industrial Ergonomics and Safety VI*, (1994) pages 182 to 186 and Figure 1, with kind permission from Taylor & Francis, 1 Gunpowder Square, London.

TABLE 4.3 Human Capability

Compare Posture, Force, Repetition Requirements for Each Task. Identify Specific Special Skills for Each Task. Delineate Human System Requirements: <ol style="list-style-type: none"> 1. Physical 2. Endurance 3. Strength 4. Manipulative 5. Environmental 6. Cognitive Emphasize Observation from Experience Rather Than from Analysis.
--

From Getty, R. L and Getty, J. M., Significance of approaching participatory ergonomics from the macroergonomics perspective: A continuous improvement process. In F. Aghazadeh (Ed.) *Advances in Industrial Ergonomics and Safety VI*, (1994) pages 182 to 186 and Figure 1, with kind permission from Taylor & Francis, 1 Gunpowder Square, London.

TABLE 4.4 Perceptual Queues

Define Resources that Assist Understanding.
 Delineate Input Information that Triggers Response.
 Evaluate Sufficiency of Available Queues.
 Determine Flexibility to Change Physical Activity.
 Assess Empowerment, Level of Decision Making and Self-Determination.

From Getty, R. L and Getty, J. M., Significance of approaching participatory ergonomics from the macroergonomics perspective: A continuous improvement process. In F. Aghazadeh (Ed.) *Advances in Industrial Ergonomics and Safety VI*, (1994) pages 182 to 186 and Figure 1, with kind permission from Taylor & Francis, 1 Gunpowder Square, London.

TABLE 4.5 Potential Assistance

Work Aids to Provide Better Understanding.
 Mechanical Assistance for Physical Demands.
 Work Rate Flexibility.
 Methods to Eliminate Potential Error, such as:

1. Better Flow
2. Only One Way to Install

Improvement of Work Environment.

From Getty, R. L and Getty, J. M., Significance of approaching participatory ergonomics from the macroergonomics perspective: A continuous improvement process. In F. Aghazadeh (Ed.) *Advances in Industrial Ergonomics and Safety VI*, (1994) pages 182 to 186 and Figure 1, with kind permission from Taylor & Francis, 1 Gunpowder Square, London.

TABLE 4.6 Task Assignment

Assign Task that Conforms to Match of Operator, Machine or Customer Skills.
 Design Flow that Maximizes the Success of Assigned Task.
 Perform Task Analysis on New or Changed Process.
 Review Task by Process Designers, Operators and Management.
 Perform Trade-off Assessment for Business and Human Benefit.

From Getty, R. L and Getty, J. M., Significance of approaching participatory ergonomics from the macroergonomics perspective: A continuous improvement process. In F. Aghazadeh (Ed.) *Advances in Industrial Ergonomics and Safety VI*, (1994) pages 182 to 186 and Figure 1, with kind permission from Taylor & Francis, 1 Gunpowder Square, London.

TABLE 4.7 Simulation

Test and Evaluate Each Stage of Product/Process Development.
 Involve Operator, End-user, Customer.
 Provide Sufficient Realism to Represent Processes.

From Getty, R. L and Getty, J. M., Significance of approaching participatory ergonomics from the macroergonomics perspective: A continuous improvement process. In F. Aghazadeh (Ed.) *Advances in Industrial Ergonomics and Safety VI*, (1994) pages 182 to 186 and Figure 1, with kind permission from Taylor & Francis, 1 Gunpowder Square, London.

TABLE 4.8 Modification

Modify As Soon as Correction is Identified.
Constantly Review Processes Based on Performance.
Solicit Modification Suggestions from All Sources:
1. Management
2. Designers
3. Process Operators
4. Customer
Overcome Status Quo Attitude.

From Getty, R. L and Getty, J. M., Significance of approaching participatory ergonomics from the macroergonomics perspective: A continuous improvement process. In F. Aghazadeh (Ed.) *Advances in Industrial Ergonomics and Safety VI*, (1994) pages 182 to 186 and Figure 1, with kind permission from Taylor & Francis, 1 Gunpowder Square, London.

Step Two — Task Analysis

The process of task analysis performed by those most familiar with the processes takes on a new meaning when an engineer unfamiliar with the process environment performs this analysis. The research performed to develop the needs for improvement and the elements of the process increases one's awareness of activity that in the past was taken for granted. By reviewing elements of the processes, the required interfaces, and coordination process, participants develop an important capability to suggest or initiate realistic changes.

Step Three — Human Capability

Considering the capability of those performing a process by individuals familiar with the processes is the most logical and efficient approach. It is in this area that the intuitive nature of ergonomics is most clearly illustrated. There are areas of biomechanics and anthropometry that approach the technical and must be applied by qualified individuals. However, process-operators with proper guidance can more clearly identify the details of the tasks. In addition, any peculiarities of the tasks that are unique from the textbook approach will be missed by those not familiar with the process.

Step Four — Perceptual Queues

Clearly, those familiar with processes can identify the reality and sufficiency of perceptual queues required for their accomplishment. Others not familiar with specific tasks may well see what should be available to the worker rather than what is actually present. The preferred approach would be an individual performing the process to team with another who is an observer and can inspire insight into the elements that constitute the job. Individuals in the same workplace or service process, following training observing others in different processes than their own, can detect details not seen by those performing that process. Observers can watch another process and then have others watch their process.

Step Five — Potential Assistance

Again process-operators follow through on their experience after an orientation into ergonomic precepts. They identify improvements that they may have observed in the past. Deficiencies of processes may have been considered numerous times by those performing the process, but they have not been provided the opportunity, nor the skills, to articulate viable solutions.

Step Six — Task Assignment

A team provided by process designers and process-operators can best complete task assignments. Awareness of the work environment will provide the realism to detailed task assignments. Process-operators who have been involved with the application of ergonomics precepts from the start develop qualifications that are not easily obtainable in the average continuous improvement effort. The process itself elevates the capability of workers, service providers, and management in the performance of continuous improvement efforts.

Step Seven — Simulation

Simulation designed and accomplished by process-operators solves the majority of the deficiencies found in unrepresentative simulations. For improvement of existing processes and for the design of new processes, workers become active participants in improvement.

Step Eight — Modification

When participatory ergonomics becomes the methodology of continuous improvement, then modification becomes an ongoing activity. Becoming totally involved in the application of ergonomic precepts by process-operators, managers, and customers creates an awareness of the human element that is vital to the success of all the processes that produce an organization's product or delivers its services.

The application of ergonomic precepts becomes a clear method of identifying with many of the goals of continuous improvement that are often missed by those closest to the processes slated for improvement. First the application of this model must have an atmosphere that is developed by approaching change from the macroergonomic perspective. Then the participation of all elements throughout the organizational structure will follow.

4.6 Measuring Results

Unique Contribution of Ergonomics to Design Activity and to Company Processes

As industry moves into a world-class competitive environment, continuous improvement efforts must consider the human element in order to be successful. Even in the most automated factory or the most labor-intensive service processes, the common denominator is the capability of the worker. With clear descriptions of the physical demands and identification of ergonomic hazards or physical stressors in the workplace, better processes can be developed to achieve the organization's purpose. By continually improving the fit between the job and the worker, processes are continuously being improved.

Essential elements of ergonomics include: (1) Ergonomics design function throughout product or service life cycle from conception, design, development/production, delivery, support, continuing through obsolescence; (2) concentration on the human-machine system; (3) machine aspects cover display, information, and control processes; (4) human aspects entail sensory mechanisms, information/decision processing, and alternatives/effectors for control movement and command processes; (5) environmental aspects address the work space, the environment, and the work organization; (6) application of the ergonomic tools of task analysis and task allocation; (7) extensive training of process owners of the application of ergonomics to meet the objectives of the organization, processes, and individual workers.

Ergonomics principles must be integrated with: (a) all functions of the manufacturing process, (b) the design of new manufacturing processes during product design, (c) the process analysis techniques to improve manufacturing processes, (d) the root-cause analysis of workmanship defects, (e) the purchase of tools and equipment for facilities, plant maintenance, and factory workers, and (f) the improvement of the office environment throughout the company. The primary goal will be to enhance the workplace environment and improve productivity, quality and minimize potential for injury.

Value Added to Design Activity and to Company Processes

Performance metrics show the value added as one progresses through the phases of system design, manufacturing development, and implementation. The following delineate the benefits to industry from the consideration of human–system interaction in manufacturing processes with metrics that can be used to verify the success of a design.

Include ergonomic principles in the development of new processes before they reach the factory floor. Metric: reduced make-it-work engineering changes.

Lower overall costs of tooling, fixtures, and processes due to reduced rework. Metric: lower tool change orders.

Reduced schedules due to better match with human skills by integrating ergonomics methods with management of cost, quality, and schedule. Metric: on-schedule and in-station work flow.

A continually evolving simplification of physical demands that improves productivity and quality is consistent with continuous improvement. Metric: improving trends for productivity and quality.

Provide ergonomic inputs to design of processes to attain increased productivity and quality at less cost. Metric: improved productivity.

Quality improvements through reduction of rework due to human error. Metric: decreasing quality defects requiring rework.

Physical demands data become available for the supervision of exposure to the work hazards. Metric: reduced lost time due to fatigue and injury.

Return-to-Work (RTW) gains by an ergonomic focus by pulling together the elements that must be integrated. Metric: reduced lost workdays.

Individuals are able to understand the various factors that expose them to cumulative trauma and have a role in reducing their exposure. Metric: fewer cumulative trauma incidences.

Physical description of the tasks can be used to improve medical treatment. Metric: lower workers' compensation costs.

4.7 Conclusion

Designing quality into production or service processes can best be achieved by considering the capabilities and capacities of human performance. All processes in both service and manufacturing industries are completely dependent on effectively meeting the needs of those performing the tasks. Assessing those needs and designing processes that satisfy them enhance the talents of the worker. The goals for improving processes to achieve better quality can best be realized by integrating and applying ergonomic precepts so that those carrying out the process are accommodated. The definitions of the inputs for early involvement in process design will be best formulated through ergonomics. Those who perform, manage, and interact with the operational processes are the experts in process improvement. The application of the principles of ergonomics provides the means to design quality processes.

This chapter has focused on the techniques of enhancing the quality effort with the principles of ergonomics. Indeed both initiatives improve total business processes. Additional approaches for blending these efforts can be seen from the quality orientation, (Stuebbe and Houshmand, 1995) and from the view of comparing major trends that have occurred in both ergonomics and quality (Drury, 1997). Both of these approaches agree with the premise of this discussion, namely, that human-oriented ergonomics is closely related to and an integral part of continuous improvement processes.

References

- Alexander, D. C., *The Practice and Management of Industrial Ergonomics*, Prentice-Hall, Englewood Cliffs, 1986.
- Armistead, C. G., Design of service operations, in *Operations Management in Service Industries and the Public Sector*, Voss, C., Armistead, C., Johnston, R. and Morris, B., Eds., Wiley, New York, 1985.
- Conti, T., *Building Total Quality: A Guide for Management*, Chapman & Hall, New York, 1993.

- Crosby, P. B., *Quality is Free*, McGraw-Hill, New York, 1979.
- Drury, C. G., Ergonomics and the quality movement, *Ergonomics*, 40-3, March 1997.
- Edosomwan, J. A., *Integrating Innovation and Technology Management*, Wiley, New York, 1989.
- Garrigou, A., The role of the ergonomist in the case of workers' participation in the design of complex industrial installations, in *International Ergonomic Association Congress Proceedings*, IEA, Paris, 1991.
- Getty, J. M., *An Investigation of the Perception of Delivered Quality at Different Levels of Organizational Hierarchy in Services*, Dissertation, University of North Texas, Denton, Texas, 1993.
- Getty, R. L., Cost justification of ergonomics improvements, in *Human Factors in Organizational Design and Management — V*, Brown, O. and Hendrick, H. W., Eds., Elsevier Science B. V., Amsterdam, 1996.
- Getty, R. L., Physical demands of work are the common reference for an integrated ergonomics program, in *Proceedings of the Human Factors and Ergonomics Society 38th Annual Meeting*, HF&ES, Santa Monica, 1994.
- Getty, R. L., Continuous improvement efforts often dictate organizational change: What are the mechanisms for change? in *Proceedings of the Human Factors Society 36th Annual Meeting*, HF&ES, Santa Monica, 1992a.
- Getty, R. L., Clearing the fog of continuous improvement, *Manage* 44, 1992b.
- Getty, R. L., Abbott, W. L. and Getty, J. M., ISO 9000 methodology enhances ergonomics effort: Ergonomics becomes a tool for continuous improvement, in *The 49th Annual Quality Congress Transactions*, ASQC, Milwaukee, 1995.
- Getty, R. L. and Getty, J. M., Significance of approaching participatory ergonomics from the macroergonomics perspective: A continuous improvement process, in *Advances in Industrial Ergonomics and Safety VI.*, Agahazadeh, F., Ed., Taylor & Francis, London, 1994.
- Getty, R. L. and Getty, J. M., Organizations hold the initiative for improvement: The need for self-assessment by process owners, in *The 47th Annual Quality Congress Transactions*, ASQC, Milwaukee, 1993.
- Goldberg, B., Manage change — Not the chaos caused by change, *Management Review* 81, 1992.
- Imada, A. S., The rationale and tools of participatory ergonomics, in *Participatory Ergonomics*, Noro, K. and Imada, A., Eds., Taylor and Francis, London, 1991.
- Hatch, M. J., The dynamics of organizations culture, *Academy of Management Review* 18, 1993.
- Liker, J. K. and Joseph, B. S., Ergonomic knowledge in a U.S. automotive plant: Correlates of practical and theoretical job analysis capabilities, in *Human Factors in Organizational Design and Management — II*, Brown, O., Jr. and Hendrick, H., Eds., Elsevier Science Publishers B. V., North Holland, 1986.
- Sparks, R. and Dorris, J. M., Organizational transformation: Continuous improvement of productivity through quality, *Advanced Management Journal* 55, 1990.
- Steele, L. W., *Managing Technology*, McGraw-Hill, New York, 1989.
- Stephanou, S. E. and Spiegl, F., *The Manufacturing Challenge: From Concepts to Production*, Van Nostrand Reinhold, New York, 1992.
- Stuebbe, P. A. and Houshmand, A. A. (1995). Quality and ergonomics, *Quality Management Journal*, Winter, 1995.
- Van Donk, D. P. and Sanders, G., Organizational culture as a missing link in quality management, *International Journal of Quality and Reliability Management* 10 (5), 1993.
- Womack, J. P., Jones, D. T. and Roos, D., *The Machine that Changed the World*, Rawson Associates, New York, 1990.

5

Corporate Cost Avoidance Using Sound Ergonomics Technology and Quality-Based Customer Services

5.1	Introduction	5-1
5.2	The Project Plan.....	5-1
5.3	A Quality Approach.....	5-2
5.4	The Corporate Ergonomics Group.....	5-2
5.5	Services Developed.....	5-3
	Ergonomics Coordinator • Chair Fittings • Worksite Evaluations • Resources Room • Training • Consulting • Medical Management • Written Materials • Software	
5.6	Accomplishments and Performance Metrics	5-7
	Creating and Responding to Demand • Reductions in Pain and Suffering • Was There Return on Investment?	
5.7	Quality Metrics and Awards.....	5-11
5.8	Community Outreach	5-13

Dwight P. Miller
Sandia National Laboratories

5.1 Introduction

Although Sandia National Laboratories (SNL) has been performing ergonomic assessments and studies since the late 1970s, it was not until the spring of 1992 that SNL initiated a concerted effort to develop a corporate ergonomics program. The program has been developed with great success. Data from the 1993–96 period indicate that the once increasing rate of musculoskeletal injuries and illnesses has been turned around into a decreasing rate. Associated costs have been lowered, while employee satisfaction with services and worker productivity have remained high. This chapter describes the plan, quality approach, processes, and tools developed, and reviews performance statistics that qualify Sandia’s corporate ergonomics program as a success.

5.2 The Project Plan

The program began with assigning a project manager and forming a process management team to identify needs and plan the program’s development. We felt it was important to include representatives from all departments affected by or contributing to the activity. By the fall of 1992, a project plan was written

and approved by management. Phase one was dedicated to the development of program infrastructure. That is, staff had to be trained to provide services and standard processes had to be developed and documented. Care was taken not to duplicate a mistake made by others, in overselling the services before capacity had been grown, thereby creating a backlog that might undermine credibility.

Phase two was to identify areas at SNL that needed ergonomics help the most and to train management on the benefits of ergonomics and the services made available. Because 90% of Sandians work in offices with computers, emphasis was put on creating helpful literature for them and developing a standardized, detailed checklist for performing office worksite evaluations.

Phase three embodied moving from a predominantly reactive to a more preventive approach. This meant getting the workers involved and teaching them how to avoid poor work design. Special project teams were formed with the line organizations to work together toward risk identification and reduction. Employee and contractor training was instituted en masse, but on a voluntary basis, so that ergonomics would avoid the stigma of being just another enforced safety and health requirement.

5.3 A Quality Approach

We did not set out to embody the “Q word” when we began to pull together a program; we just wanted to do what was right. We wanted to know how others had done it, so we called 56 companies and visited eight sites with established programs (McKeen and Miller, 1993). We found out later this was called “benchmarking.” We also wanted to know what was expected of the team as we formed a charter and outlined tasks; this was called “interviewing stakeholders.” We systematically evaluated ergonomic task chairs and VDT workstations in two independent public events that involved general laboratory staff, facilities representatives, and folks from purchasing. We learned that this was called “establishing requirements with your suppliers” (Leger et al., 1989).

After a while, we started consciously utilizing the quality approach and began to design services with future metrics in mind. We established an ergonomics coordinator and designed a triage procedure to prioritize customer requests on the basis of medical need. Existing services were documented via flowcharts as were newly developed alternative procedures. A customer survey was designed and implemented to quantify customer satisfaction with various aspects of the program and collect input on what needed improvement (see Section 5.7). Team members who could not live up to the performance standards established by the group were asked to find other work that had lower standards. We tracked accident and illness data to monitor what impact we had on work at SNL. Eventually, after several years of process refinement, the program earned a reputation for quality and won some prestigious awards. Because quality is an approach that applies to all aspects of the program, additional details can be found in the following sections.

5.4 The Corporate Ergonomics Group

As an outgrowth of the process management team, a Corporate Ergonomics Group (CEG) was formed with similar professional diversity. Members came from existing corporate resources in safety, medical, education, facilities, industrial hygiene, and human factors disciplines. Each recruit/volunteer either had a background directly relevant to ergonomics or one conducive to working in ergonomics (e.g., the training specialist was previously a registered nurse). Members from our California laboratory were involved from the earliest activities through 1994, when our budget was separated and they became their own separate entity. Many of our processes, course work, and written documents were based on the California group’s precedents and contributions.

A consistent philosophical and methodological approach was fostered by sending members to three short courses taught by internationally renowned university professors: one in advanced VDT workstation design, and two covering general occupational ergonomics. All CEG members were committed to acquiring the required training, performing customer services, and attending CEG meetings. Teamwork was nurtured by holding annual off site strategic planning meetings, weekly CEG meetings, practicing group problem-solving, and by developing a group mission statement, values list, logo, and tag line (Figure 5.1).

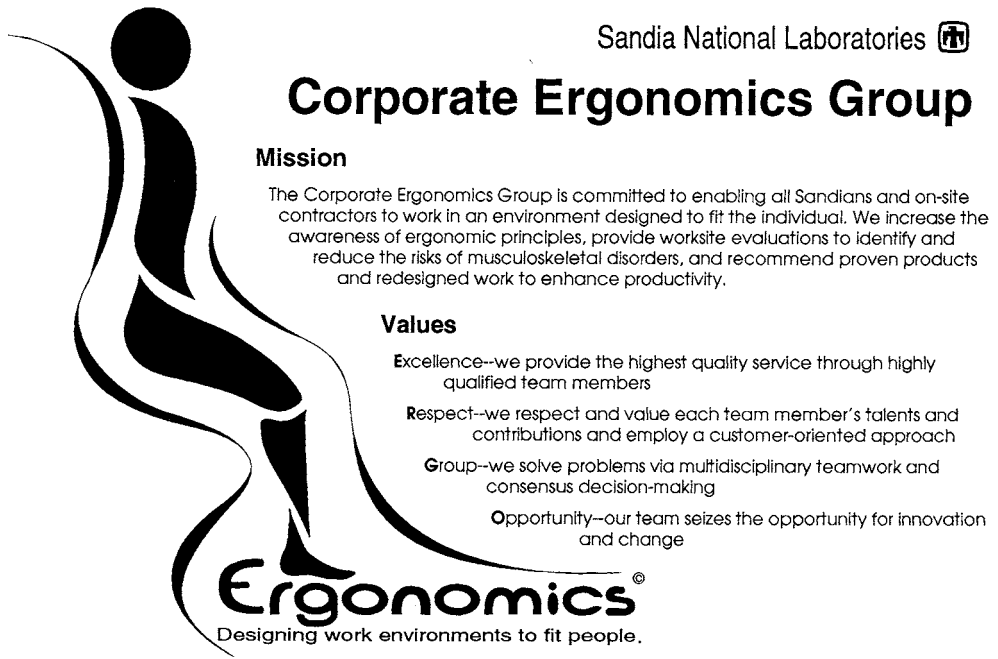

FIGURE 5.1 Corporate Ergonomics Group logo, mission statement, and values.

Consistent with a quality approach, when CEG meeting productivity began to wane, sub-teams were formed on a voluntary basis with specific responsibilities. The sub-teams elected their leaders, prioritized tasks, met whenever necessary, and reported progress to the rest of the group. The CEG meetings were consequently held only monthly and followed a strict, timed agenda to ensure high productivity. Guest speakers and suppliers were periodically invited to address topics of interest or demonstrate new products.

5.5 Services Developed

During phase one of the project plan, several customer services were developed, based on customer needs. Throughout the project plan, service processes were modified based on experience and customer input.

Ergonomics Coordinator

Interdisciplinary teams are fine, but when the members are not collocated, communication can suffer. We established an ergonomics coordinator (EC) to handle all incoming calls from customers and match their needs to our resources. This required some basic ergonomics training so that a triage procedure could be used by the EC to determine the level of priority and urgency of response. Upon receiving a call, the EC filled out a form with all of the relevant customer and problem information. She then assigned a priority category, based on symptoms, and scheduled one of the CEG members to respond, based on pre-established time blocks of member availability. All information relating to symptoms was handled as private. A memorandum was then faxed to the caller's supervisor stating that one of the services had been arranged, what it consisted of, and how much it could potentially cost. The service was free, but any purchases were paid for by the customer. The EC also used judgment in matching CEG members' skills with the nature of the customers' needs.

The EC coordinated paperwork resulting from worksite evaluations (WSEs), kept files, and maintained a database on service calls. Periodically the EC would inform members which of their customers were returning required paperwork and which were not. A second, back-up coordinator was added to cover for the EC when she was not at the office. This kept returned-call and scheduling delays to a minimum

and helped maintain high customer satisfaction. The EC also helped the project manager communicate with the CEG, schedule meetings, and distribute the minutes.

Chair Fittings

In addition to the standard office seating provided by the facilities people, the program offered 10 alternative models through a chair-fitting process. Customers set up times with the EC to visit either our ergonomics resources room or the medical center. Each had a full complement of sample chairs, so location was determined by proximity to the customer's office and medical requirements. A CEG member would meet the customer, proceed through a series of questions concerning the job requirements, functional loss assessment, height and weight, and look up the ideal subset of chairs on a chart and then invite the customer to try out the models in that subset. After some sitting and some adjusting, the fitter and the sitter would mutually agree on the best chair. In many cases, models would be ordered with larger or smaller seat pans, different foam, adjustable lumbar supports, or other options based on customer needs and preferences. Affordability and appropriateness were determined by the customers' management. Using this process, the CEG reduced the delay in acquiring custom ergonomic task chairs from 2 to 9 months to 4 to 6 weeks, with special medically related rush orders taking only two weeks. Company policy allowed customers to keep their individual chairs regardless of subsequent moves within the company. In the rare event that a customer was dissatisfied after chair delivery, we determined if the CEG had made an error in prescribing the chair, and if so, the chair was reapplied and another chair was provided at no charge.

Worksite Evaluations

As in any active ergonomics program, CEG members went to the customers' worksites to assess the materials, tools, processes, and environment for musculoskeletal stressors or other factors that could lead to work-related musculoskeletal disorders or inefficient operations. This service was considered to be the backbone of the program. The flow of the process, from initial call to final paperwork is shown in Figure 5.2.

Having not found a suitable checklist off-the-shelf, the CEG developed its own four-page, graphically based, field checklist, partially displayed in Figure 5.3. It served as a guidance and data-collection tool that was refined iteratively, using field experience. In addition to customer information, existing ergonomic equipment and furniture, tasks and durations, postures, office layout, and existing workstation measurements were recorded. The last section provided space for recommendations. A similar checklist was developed for non-office work environments.

Prior to performing WSEs, new evaluators attended professional training classes, read a guidelines document, and accompanied senior ergonomists on WSE calls. Eventually, the new evaluators performed the WSE under the guidance of the senior member, and when both were confident, the fledgling was allowed to fly solo. The author felt this was an important safeguard to reduce the liability of giving a customer bad advice on how to work. Typically, a CEG member performed about three WSEs a week, which would take about a half-day. This relatively light level of effort allowed the program to tap into existing laboratory personnel resources and avoid the need to hire new staff.

Occasionally, an entire work area or department was identified for evaluation. In these cases, several team members met with department representatives to form a joint project team to investigate ergonomic issues. We found that without involvement in developing solutions from the host organization, the best ideas had almost no chance of acceptance.

Resources Room

A resources room was set up to house the physical assets of the program (pamphlets, alternative keyboards, training materials, etc.) and provide space for chair fittings and analysis of videotaped jobs. The ergonomics video and text library was also housed in the resources room. A company vehicle was provided for transportation to customer appointments throughout the technical areas of the laboratories, which cover 2830 acres.

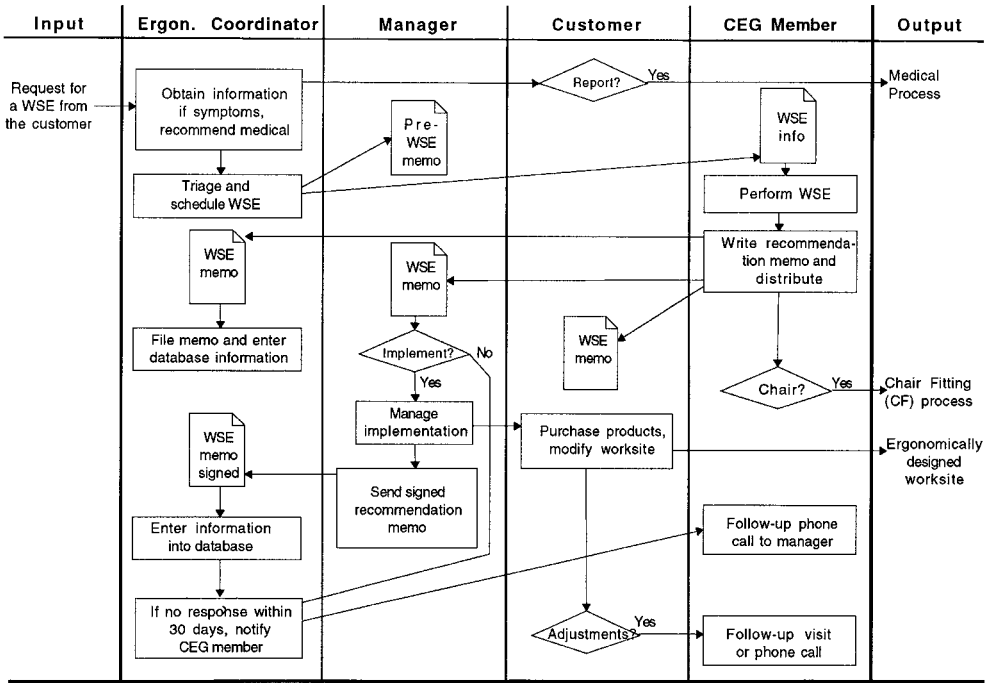

FIGURE 5.2 Worksite evaluation process flow chart.

Circle nominal postures. Measure and document problem postural angles on line provided.

Head

0° → 10° **A** — **B** — Check here if forward head posture should be evaluated. Refer to physical therapist.

Neck

0° → 10° **C** — 0° → 10° - 20° **D** — 0° → > 20° **E** — **F** — **G** — **H** —

Shoulder

I — **J** — **K** — **L** —

Trunk

20° 0° **M** — **N** — 0° 20° **O** — 0° 20° - 60° **P** — **Q** — **R** —

Wrist

0° — **S** — 15° 15° **T** — >15° 0° **U** — <20° >20° **V** — >20° >20° **W** —

Left _____ Right _____ Left _____ Right _____ Left _____ Right _____ Left _____ Right _____ Left _____ Right _____

FIGURE 5.3 Section of worksite evaluation checklist. (From Nina Stewart-Poppelsdorf, CIH, CPE. Copyright Sandia National Laboratories, 1994. With permission.)

Back Injury Reduction Program

The CEG, together with the medical department's preventive health care program, developed courses and services for workers exposed to the physical stressors of material-handling and lifting tasks. One course was unique in that it embodied a long-term, behavior-modification approach to lifting. Participants demonstrated lifting skills prior to and after a four-week curriculum of one hour per week. Follow-up sessions on job-relevant topics occurred every quarter for 18 months. Management incentives were designed to encourage maximum participation and onsite lifting coaching was provided on demand by exercise-physiology and physical-therapy interns.

Training

Three ergonomics courses were developed in-house: employee awareness, management awareness, and advanced ergonomics for environmental, safety, and health (ES&H) and facilities professionals. The employee course was designed for mass audiences and could be modified from 20 minutes to one hour in length. Musculoskeletal stressors were identified and CEG services described. Approximately ten minutes of the class were devoted to playing an in-house videotape entitled "Ergonomics Detective C.T. Dodd" (Corporate Ergonomics Group, 1995). The video used a humorous "Mike Hammer" style to convey the concepts of ergonomics without inducing involuntary narcolepsy.

The managers' course was designed to be given in small groups, as in director's staff meetings. In addition to the basic concepts, injury and illness statistics for each organization are emphasized to cultivate sensitivity to lost-workday costs. Additionally, simplified surveillance checklists were added to the training materials so that managers could walk their spaces and identify musculoskeletal stressors before they became physical symptoms. The advanced course, which was four hours long, covered all the essentials and provided hands-on workstation evaluation and redesign techniques for staff who could use the skills in their regular work.

The CEG also instituted the Ergonomics Colloquium. About once a year, a well-known ergonomist would visit the CEG to consult on its development and present a one-hour colloquium to the laboratory staff on a technical topic of interest. Speakers were videotaped for people who could not attend the live colloquium. Dr. Roger Stephens from OSHA and Professor William Marras from The Ohio State University were the colloquium speakers in 1994 and 1995, respectively.

Consulting

In addition to the bread-and-butter services outlined above, occasionally the CEG was called upon to provide consulting in unique situations. Several times we were asked to join teams tasked with redesigning work rooms or entire work areas, such as the classified document vault and document delivery service center in the technical library. Other projects included the mail room, shipping/receiving, the corporate computing center, and a hazardous waste management facility.

Medical Management

Communication and coordination on medical issues were facilitated by the fact that four members of the CEG were employed by the medical department: one doctor, two nurses, and a physical therapist. Screening and diagnosis procedures for work-related musculoskeletal disorders were developed, documented, and used by the primary care physicians. Onsite physical therapy was available, as well as an onsite optician, who filled prescriptions for VDT glasses. Due to lack of empirical evidence justifying lumbar belt usage, the company denied employees lumbar belts except when healing from an injury, and only if prescribed and fit by a health-care professional. A mutual referral system was instituted whereby if a symptomatic employee called for a WSE, he was referred to Medical, and if he showed up in Medical, he was referred to the EC for a WSE appointment.

Written Materials

In addition to the many off-the-shelf educational pamphlets and booklets used by the program to educate Sandians, the CEG developed several of its own. The most popular was a tri-fold that discussed ergonomics for computer users. Based on a similar pamphlet developed at the Lawrence Berkeley Laboratory, it used graphics from Apple Computer Inc. to demonstrate proper workplace biomechanics and text to explain use of accessories and who to call for assistance (Mulligan et al., 1994). In addition, two booklets were developed, complete with photographs, detailing safe exercises to use to stretch and strengthen musculoskeletal subsystems undergoing stress associated with work (Suzuki et al., 1995a,b). They were written by two physical therapists who researched the literature on exercises and found that many being prescribed actually exacerbate work-related strain by exercising the affected tissues in ways similar to the work itself. One booklet was targeted directly at office-related tasks, while the other addressed stressors encountered at home. Finally, as is true of most large institutions, Sandia has a comprehensive ES&H Manual. The CEG, with help from its California colleagues, developed a manual chapter containing a complete set of ergonomic guidelines for office work (McMahon and Miller, 1995). The manual is now issued electronically on the Sandia intranet. Although none of these products was particularly innovative, excepting perhaps the exercise booklets, the concise format, familiar style, and repackaging of information made them extremely useful to Sandia employees.

Software

Throughout the program's life, various software packages were evaluated for both CEG and customers' use. We always looked at price and ease of use as foremost considerations in addition to functionality and time savings. Some of the packages we evaluated were more vaporware than actual product, and many of the legitimate, finished, commercial products were extremely difficult to use. Several were so costly that we decided we could do the work manually. We chose LifeGuard® for reminding serious computer users to take alternative-work breaks occasionally, and ErgoSmart® for general information in a question/answer format. Site licensing made these products affordable. In an unrelated feasibility project, the WSE checklist was programmed into a pen-based portable computer, designed for field data collection and automated database entry. Despite showing initial promise, problems with battery life and handwriting recognition software in the feasibility testing precluded implementation.

5.6 Accomplishments and Performance Metrics

By any standard, the program was immensely successful. The teamwork demonstrated within the CEG set a new benchmark for interdisciplinary matrixed projects within the ES&H organization. Customers loved the individual attention and expert advice they received. The injury/illness statistics dropped consistently for four years. The money spent on program development and operation was recovered easily in reduced lost-time illnesses. Effectiveness was maintained even during budget reductions after the program was developed. The following sections discuss specific accomplishments and various performance metrics in more detail.

Creating and Responding to Demand

As plotted in Figure 5.4, the number of WSEs increased initially as services were introduced and then reached asymptote in 1995. When benchmarked against other similar institutions, SNL had the highest asymptotic level of WSEs provided. Chair fittings were introduced in 1993 as a standard service and have increased steadily since. Worksite evaluation performance not only increased in numbers (up by a factor of three), but also responsiveness. According to the 1994 survey, 57% of the customers received WSE services within 2 weeks, and 82% within one month of the initial call. The new triage priority system ensured a five-day response to symptomatic callers. Customers previously received documentation of

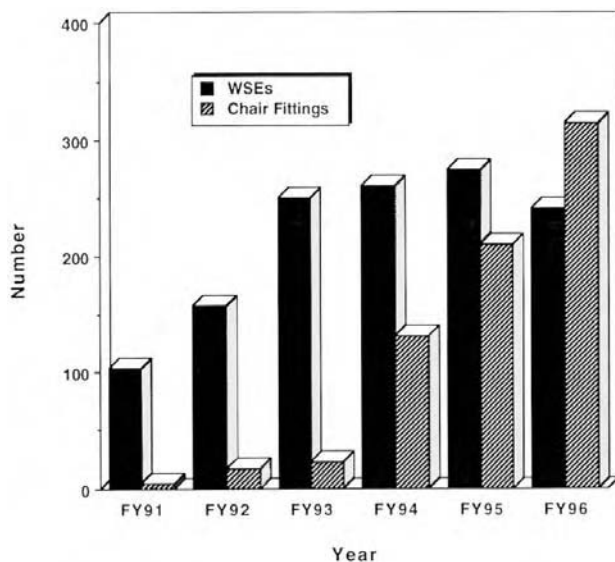

FIGURE 5.4 Number of worksite evaluations and chair fittings performed.

recommendations in 1 to 3 months due to dictation delays. Feedback time was reduced to less than one week by using a computer template distributed to all CEG members.

In the last two years, training has reached approximately half of the Sandia population. This is not remarkable unless you consider that it was not required training, except for incoming secretaries. Feedback on the instructors and content has been very favorable, and most attendees loved the aforementioned video. A few managers have adopted the surveillance checklists in their yearly walkthroughs, generating additional requests for WSEs.

Reductions in Pain and Suffering

Four out of five (79%) symptomatic customers who made the recommended ergonomic improvements experienced symptom relief in the 1994 quality survey. This figure was up from the 1992 figure of 70% (see Figure 5.5). From a medical case standpoint, before we could calculate our gains on work-related musculoskeletal disorders, we had to establish criteria for case inclusion. We defined them as cumulative trauma illnesses or musculoskeletal soft-tissue injury (such as a strain) obtained while performing a repeated, regular job task in a less than ideal manner (a manner that could be improved using common ergonomic practices). We also put on the stipulation that the injury or illness occurred while performing assigned work, leaving out the weight-room lifting injuries of the guard force, and the occasional luggage-toting strain experienced during business travel. These restrictions tended to make our performance metrics conservative.

Using the data-inclusion criteria, we calculated numbers of cases, and associated costs for four years of the program (Figure 5.6). As can be easily observed, both the number of cases and the associated costs have consistently dropped over the four-year period. The costs were calculated using a conservative formula developed for Department of Energy (DOE) contractor facilities in 1988, accounting for lost work time, lost productivity, and medical expenses. In the years 1993 to 1995, the costs associated with cumulative trauma were 30% higher than other cases, and required almost 16 days away from work, compared to 9 days away for other types of work-related injuries and illnesses (Figure 5.7).

As might be expected in a research and development laboratory, upper extremity cases consistently outnumbered spinal problems in the three years audited (Figure 5.8). When analyzed for job location and type of work being performed, the pattern shown in Figure 5.9 obtained. Office workers suffered the most, followed by material handlers and laborers, with laboratory technicians and crafts/trades people showing the fewest WRMSDs.

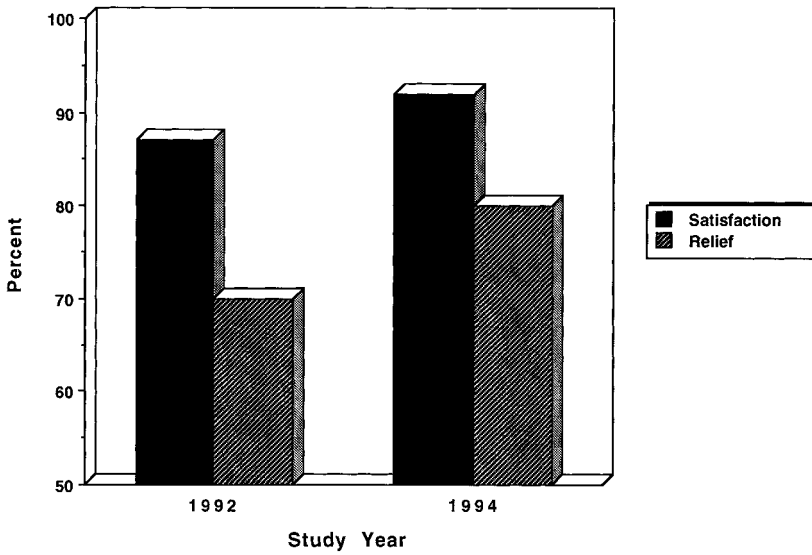

FIGURE 5.5 Relief of symptoms and overall customer satisfaction.

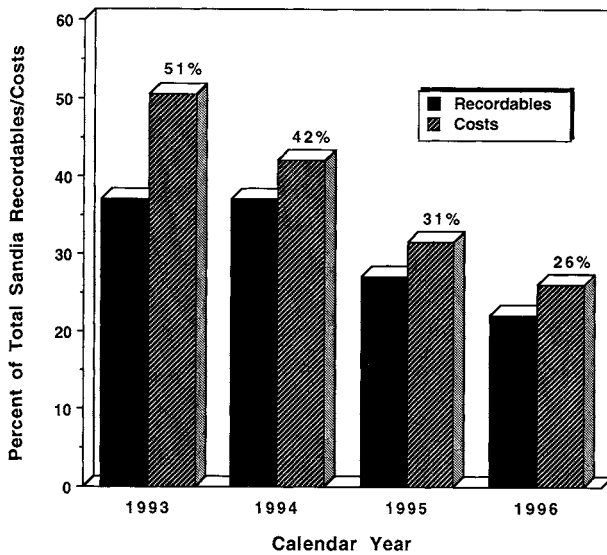

FIGURE 5.6 Ergonomics-related cases as percent of total recordable cases and total costs.

Was There Return on Investment?

Perhaps the ultimate metric for program success is a benefit-cost analysis, taking into account how much money was expended and what was gained as a result. Figure 5.10 compares program budget figures and costs associated with work-related musculoskeletal disorders for the years 1993 through 1996. (The program costs do not include equipment purchases made by employees, or costs involved with remodeling work areas, only the money spent on developing and administering the program.) As the figure suggests, the costs associated with work-related musculoskeletal disorders were over a million dollars each year prior to 1995. The program's budget was about \$160k in 1992, followed by \$280k and \$585k in 1993 and 1994, respectively. Although we cannot claim a clean cause and effect relationship (we had no control

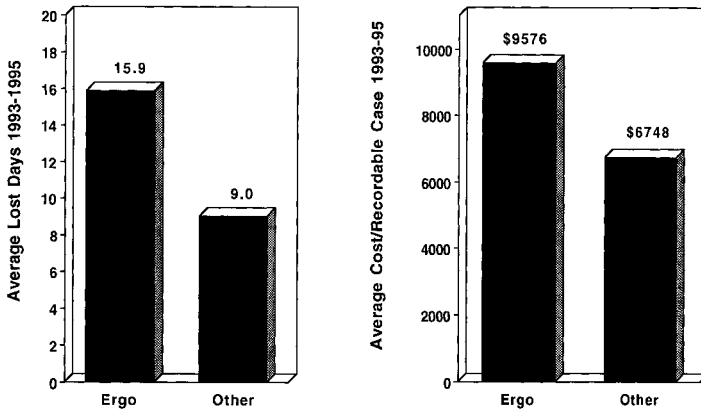

FIGURE 5.7 Average lost days and costs associated with ergonomics-related illnesses.

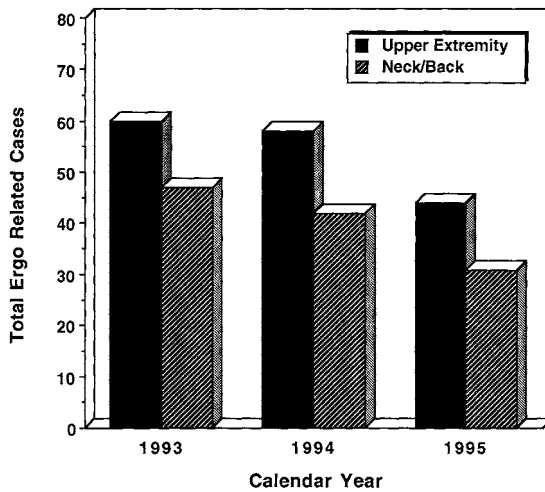

FIGURE 5.8 Number of upper-extremity and spine-related cases by year.

over other factors), the precipitous fall in illness costs in 1995 and 1996 suggests that the program had some effect in turning around a dangerous trend of increasing costs in the early 1990s. By 1996, the costs associated with work-related musculoskeletal disorders had been reduced to approximately one sixth of what they were in 1994. The program's budget was trimmed back systematically in 1995, 1996, and 1997, taking advantage of the early development work and stressing implementation of the processes created in prior years. Budget projections for 1997 are just above the \$100k figure, signaling an 80% decrease since 1994.

Was the money well spent? I am sure the employees and contractors who received the advice and work-design benefits would reply with an emphatic "yes." Approximately 80% of the recommendations made to employees were implemented, despite customers having to purchase their own furniture and accessories. Statistically, a rapidly increasing trend in work-related musculoskeletal disorders was turned around to an even more rapidly decreasing trend. Over the four years analyzed, the money saved was equivalent to the money spent. However, if the costs associated with work-related musculoskeletal disorders remained at the 1996 level, cost savings would amount to about \$800k per year, using 1993 as the reference point. At the current funding level of \$120k, this would amount to over a 6.7:1 return on

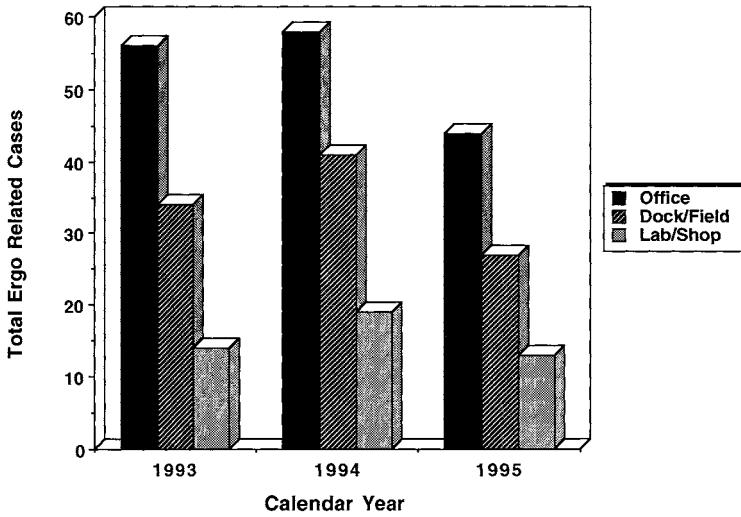

FIGURE 5.9 Number of ergonomics-related cases by job location.

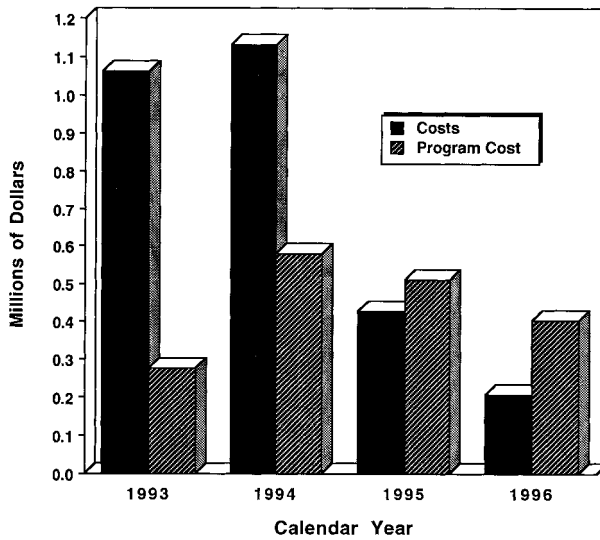

FIGURE 5.10 Comparison of illness costs and program costs from 1993 to 1996.

investment. We also discovered in our quality surveys that half of our customers perceived their productivity to increase after having implemented ergonomic improvements. Subjective estimates ranged from 5 to 15%. Assuming 135 people, paid \$40,000 in salary increased their productivity 7%, the company would have gained another \$378k per year in increased or improved work. With estimates of increased productivity figured in, the return on investment increases to just under 10:1.

5.7 Quality Metrics and Awards

In addition to objective data on services performed and case reduction, the program initiated telephone surveys to evaluate the customers' perceptions of the quality of our work. Our first survey, done in 1992,

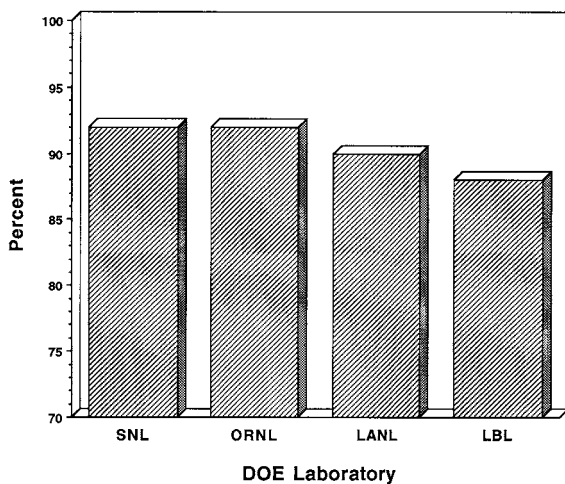

FIGURE 5.11 Percent overall customer satisfaction with ergonomics services at DOE National Laboratories benchmarked in 1995.

consisted of calling 30 people who had received benefits from the old system in 1991 and 1992. Seven questions surveyed symptom relief, satisfaction with services, and duration of waiting period for ergonomic task chairs. We discovered that on the whole, customers recovered from symptoms well, and were satisfied with the individualized services; however, they were dissatisfied with the long waits associated with chair selection and delivery. These findings were instrumental in planning the program and creating an efficient chair-fitting process.

In 1994, we redesigned the survey to include questions on all aspects of the program and administered it via telephone to 100 of our customers from the previous year. The following results are extracted from the resulting Sandia Technical Report (Longbotham and Miller, 1995). The 1994 survey respondents recorded 81% “pleased” or “very pleased” with the new chair-fitting process. Most of the remaining 19% were not happy with the WSE requirement for a new chair, so the requirement was dropped. The return rate on chairs was 6 out of 331, or about 2%. Ninety-seven of the 100 customers thought the WSE went smoothly, and overall customer satisfaction with the ergonomics processes increased from 87% in 1992 to 92% in the 1994 survey (Figure 5.5). Corroborating evidence from the 1994 Medical Center Quality Survey indicated that 156 respondents rated the program 3.97 out of 5 for responsiveness and 4.13 out of 5 for ergonomics professionalism (Sanderville, 1994). Comparable satisfaction metrics from sister DOE laboratories, benchmarked in 1995, are shown in Figure 5.11.

Metrics on training effectiveness and satisfaction were collected immediately after training sessions. Manager satisfaction with ergonomics training was high, with 100% reporting that notebook materials would be useful back on the job and that the instructor communicated well. Nine out of ten thought the instructor was prepared, knowledgeable, enthusiastic, encouraged interaction, and treated students with respect.

In 1995, the program won the Sandia President’s Quality Award. The award was based on a subset of criteria taken from the Malcolm Baldrige Award application process. Also in 1995, the videotape entitled “Ergonomics Detective C.T. Dodd,” won The Communicator Crystal Award for its effectiveness in communication and education. Lockheed-Martin identified the program as one of only three Industrial Hygiene/Safety programs worthy of receiving an “excellent” rating in its 1995 audit. Last, in an external appraisal conducted by the DOE in 1994, the program received “noteworthy recognition.” It was very satisfying for the entire CEG to experience good work being recognized, but the rewards were in knowing that pain was reduced, comfort enhanced, and productivity increased during this period.

5.8 Community Outreach

Recent reductions in budget necessitated fewer formally trained people working on the program and more leveraging the knowledge and techniques to other ES&H staff. The author has moved on to his next challenge in the company and is no longer managing the program. However, he remains involved in transferring the technologies to other companies, small and large. He is currently the Energy and Environment Sector Representative in Lockheed-Martin Corporation's Ergonomics Task Force and is pursuing the diffusion of ergonomics technologies to other companies within the corporation. He is also pioneering the application of ergonomics principles to architecture. The checklists, course materials, and training video described above are available for licensing by contacting Sandia's Licensing and Partnership Department. Please feel free to contact the author at (505) 845-9803 or dpmille@sandia.gov with questions regarding the program or the techniques developed.

Acknowledgments

The author would like to acknowledge and express gratitude to the CEG members who unselfishly gave of themselves to make the program a success. Some of them put helping Sandians find relief above doing what was politically correct for their careers. Special thanks also go to the Sandians at the California Laboratory who showed us the way by spearheading several major efforts. Our project would never have gotten off the ground without management support from Judith Mead, Larry Clevenger, Allan Fine, Joe Stiegler, Bill Burnett, and Lynn Jones. Thanks also go to those who helped us start up by letting us benchmark their operations back in 1992, or attended Energy Facility Contractors' Group meetings from 1994–1996 to share their knowledge and materials. In many cases it was their innovative ideas that helped to make our program a success. Those who directly contributed to the program's development are listed below:

Eric Grose	Don Bridgers	Tom Faturos
Deborah Mulligan	Carol Meincke	Patsy John
Hugh Whitehurst	Mary Gould	Claudia Hawkes
Margarita Ferguson	Sal Sabasco	William Ormond
Joey Boyce	Terry McMahon	Deana Butler
Nancy Spear	Nita Archambault	Gloria Holtzclaw
Larry Powell	Linda Edlund	Larry Suzuki
David O'Brien	Sam Walters	Nina Stewart-Poppelsdorf
Patrick Girault	Kevin Babb	Gordon McKeen
Patricia DeVivi	Sandra Hansen	Lori Longbotham
Charmaine DeWerff	David Kessel	

The author dedicates this chapter to Allan Fine, who will be remembered for his trusting support, sincere compassion, and timely humor.

References

- Corporate Ergonomics Group, *C. T. Dodd, Ergonomics Detective*, video, Sandia National Laboratories, Albuquerque NM, 1995.
- Leger, E., Ackerman, R., Coleman, R., and MacDorman, J., *Process Quality Management and Improvement Guidelines*, AT&T Bell Laboratories, Indianapolis, 1989.
- Longbotham, L. and D. P. Miller, *1994 Ergonomics Program Quality Evaluation*, SAND95-0937, Sandia National Laboratories, Albuquerque NM, June 1995.

- McKeen, R. G. and D. P. Miller, *Benchmarking Corporate Ergonomics Programs for Sandia National Laboratories*, SAND92-2667, Sandia National Laboratories, Albuquerque NM, April 1993.
- McMahon, T. and Miller, D. P., *Office Ergonomics*, Chap. 3A, Sandia ES&H Manual, Rept. MN471001, Sandia National Laboratories, Albuquerque, NM, 1995.
- Mulligan, D. R., Stewart-Poppelsdorf, N., and Suzuki, L., *Ergonomics for Computer Users*, pamphlet, Sandia National Laboratories, Albuquerque, NM, 1994.
- Sanderville, K., *Quality Survey on Medical Services*, Sandia National Laboratories, Albuquerque NM, 1994.
- Stewart-Poppelsdorf, N., *Ergonomic Worksite Evaluation*, Office Checklist, Sandia National Laboratories, December, 1994.
- Suzuki, L., Mulligan, D. R., and Hansen, S., *Ergonomics Exercises at Work*, booklet, Sandia National Laboratories, Albuquerque, NM, 1995.
- Suzuki, L., Mulligan, D. R., and Hansen, S., *Ergonomics Exercises at Home*, booklet, Sandia National Laboratories, Albuquerque, NM, 1995.

6

Economic Analysis for Ergonomics Programs

6.1	Introduction	6-1
6.2	Fundamentals: Identifying Costs and Benefits of Ergonomics Activities.....	6-2
	Program Record • Supporting Data • Project Evaluations	
6.3	Method Application: Sample Calculations for Evaluating and Tracking Costs and Benefits of Proposals, Projects, and Programs	6-13
	Example 1: A. Ergonomics Program — Ergonomics Team Meetings • Example 2: B. Turnover and Training — On-the-job-training • Example 3. B. Turnover and Training — Overtime to compensate for lost production • Example 4: B. Turnover and Training — Costs due to an open position • Example 5: C. Absenteeism • Example 6: D. Productivity • Example 7. E. Rework and Scrapped Product — Rework — Direct labor costs/savings • Example 8: E. Rework and Scrapped Product — Scrapped Product • Example 9: Small Project • Example 10: Capital Expenditure	
6.4	Additional Metrics: Results-Oriented Statistics	6-19
6.5	Concluding Remarks	6-20

Carolyn M. Sommerich
North Carolina State University

6.1 Introduction

Good ergonomics often has a positive economic effect. Hendrick (1996) recounted several examples of ergonomic projects that each resulted in significant economic benefits that well outweighed initial project costs. However, unless an assessment method is in place to document both the costs and savings (or income) associated with ergonomics-related activities, only the costs may be readily apparent. Ergonomics then appears as just one more expense burden. The benefits of ergonomics, such as increased productivity and reduced expenses, must be objectively documented, just as costs are, in order to change this view of ergonomics. This chapter presents a method for continuous economic assessment of an ergonomics program.

The method presented in this chapter facilitates a comprehensive assessment of a program over time, and assessment of individual constituent projects, from proposal, to implementation, and throughout each project's life. A two-tier recording system, for tracking costs and benefits for individual projects and the program as a whole, forms the basis of the method. The chapter is divided into three main sections. The first section contains explanations of program-level cost and benefit line items and provides equations for calculations. Methods for evaluating individual projects, including capital expenditures, small projects, and light duty assignments, are also presented in that section. The next section of the chapter

contains sample calculations that demonstrate application of the material in the first section. Alternative evaluation methods are briefly discussed in the third section of the chapter (such as absenteeism rates and machine availability).

6.2 Fundamentals: Identifying Costs and Benefits of Ergonomics Activities

There are various recommended metrics by which ergonomic programs or individual projects can be evaluated. Though there is a natural aversion to reducing health and safety issues to financial terms, money is the metric of business. Increasingly, the impetus is toward evaluation of health and safety issues, including ergonomics-related activities, in monetary terms. To date, relatively little has been written on the subject of economic analysis of ergonomics-related activities. The accounts that do appear in the literature, however, describe positive economic effects from ergonomics-related activities (Helander and Burri, 1995; Hendrick, 1996; DeKraker, Lindstrom-Hazel, Cooper, and Ambrosius, 1995).

Andersson (1992a) suggested focusing on savings associated with increased productivity and decreases in absenteeism, rework and spoilage, and turnover. However, for a fair and complete analysis, that can address the question, “At what cost did we achieve _____ (outcome), and was that the best investment of company resources?” savings must be assessed relative to associated costs. Alexander (1996) recommended changing metrics as a program matures, from activity-oriented metrics (for example: program implementation milestone completions, number of projects completed successfully) at inception, to results-oriented metrics (for example: changes in health and safety statistics), and finally to systems-oriented metrics that correspond with institutionalizing the program’s practices. In accordance with these recommendations, this chapter presents a systems-oriented method for predicting, tracking, and assessing costs and savings associated with an ergonomics program and its various constituent projects.

The method presented is reasonably complete, in that it accounts for a wide range of costs and benefits associated with a program (refer to Figure 6.1). A Program Record (PR, Table 6.1) is used for program-level analysis, and an Ergonomic Project Worksheet (EPW, Table 6.2) is used to assess individual proposals and projects. Figure 6.2 depicts the flow of information within and between the forms. The forms can easily be adapted to a computer spreadsheet or database. However, the validity of the output is ultimately dependent upon the quality of the monetary estimates and other values supplied by the user. Potential sources have been provided to help the reader identify various costs or savings, or constituent values. Certain values may already be standardized within some companies. Where values are not available, they should be developed in order to perform fair and comprehensive analyses. Depending on the scope or scale of a particular program or project, some line items that appear on the forms may not require entries. Only those items that are affected by and change as a result of the ergonomics program need to be tracked. In some parts of the predictive evaluation, providing estimates of expected changes from the current situation may suffice (Konz, 1995).

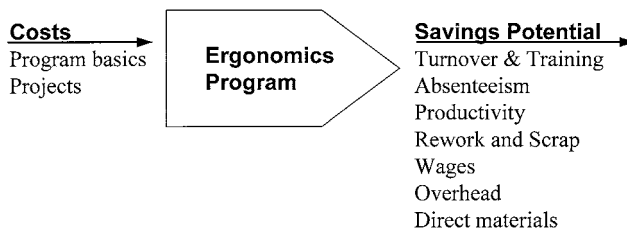

FIGURE 6.1 Categorical model of costs, savings, and income-generating areas to consider in assessing the economic effects of an ergonomics program.

TABLE 6.1 Program Record

	Costs	Benefits
A. Ergonomics Program — regular activities		
1. Meetings		
a. Lost production	_____	_____
b. Other _____	_____	_____
2. Training		
a. Lost production	_____	_____
b. Trainer/consultant costs	_____	_____
c. Materials	_____	_____
d. Other _____	_____	_____
3. Medical Management		
a. PT/OT, nurse (specific to program)	_____	_____
b. Lost production		
i. Consultation	_____	_____
ii. Treatment	_____	_____
c. Back belts, wrist supports	_____	_____
d. Other _____	_____	_____
B. Turnover and Training/Replacement		
1. Acquisition		
a. Recruitment	_____	_____
b. Selection	_____	_____
c. Hiring	_____	_____
2. Development		
a. Orientation	_____	_____
b. On-the-job training		
i. Lost production due to lack of proficiency	_____	_____
ii. Overtime to compensate for lost production	_____	_____
c. Off-the-job training	_____	_____
3. Separation		
a. Severance	_____	_____
b. Productivity decrement	_____	_____
c. Open position	_____	_____
C. Absenteeism		
1. Compensation costs		
a. Wages (including taxes, fringe)	_____	_____
b. Insurance charges or fees	_____	_____
2. Medical costs		
a. Payments to providers	_____	_____
b. Insurance charges or fees	_____	_____
3. Replacement costs (refer to Turnover and Training)	_____	_____
D. Productivity		
1. Permanent changes	_____	_____
2. Temporary changes	_____	_____
E. Rework and Scrapped Product		
1. Rework		
a. Direct labor	_____	_____
b. Lost production or overtime	_____	_____
c. Direct materials	_____	_____
d. Other _____	_____	_____
2. Scrapped product		
a. Direct labor lost	_____	_____
b. Overtime	_____	_____
c. Direct material loss, less salvage value	_____	_____
d. Other _____	_____	_____

TABLE 6.1 (continued) Program Record

	Costs	Benefits
F. Wages		
1. Direct labor, including benefits, taxes, insurance	_____	_____
2. Supervisory and administration charges	_____	_____
G. Overhead		
Items: _____	_____	_____
H. Direct materials (not listed elsewhere)	_____	_____
I. One-time costs (such as initial project costs)		
1. Equipment	_____	_____
2. Jigs and fixtures	_____	_____
3. Installation	_____	_____
4. Engineering time	_____	_____
5. Operator training	_____	_____
6. Other	_____	_____

TABLE 6.2 Ergonomic Project Worksheet

Step 1. Perform economic analysis on a proposal using payback period or one of the four methods that account for the time value of money (NPW, NAW, B/C, or ROI). Use the first set of columns on the worksheet to identify and document anticipated costs and benefits.

Step 2. Track all project costs, savings, and income throughout the life of the project. Use the second set of columns, which will facilitate comparison between projected and actual values. This will prove useful for future evaluations.

Step 3. Transfer all actual costs and benefits onto the Program Record, in order to provide information that will facilitate the evaluation of the program as a whole.

Item*	Expected Costs	Expected Benefits	Actual Costs	Actual Benefits
B. Turnover and Training				
C. Absenteeism				
.....				
I. Project costs				

Perform economic decision analysis for proposal in the area below:

State all assumptions:

Calculations:

Outcome:

Decision:

* This table is presented in an abbreviated format. It should contain items B-I that appear on the Program Record (Table 6.1).

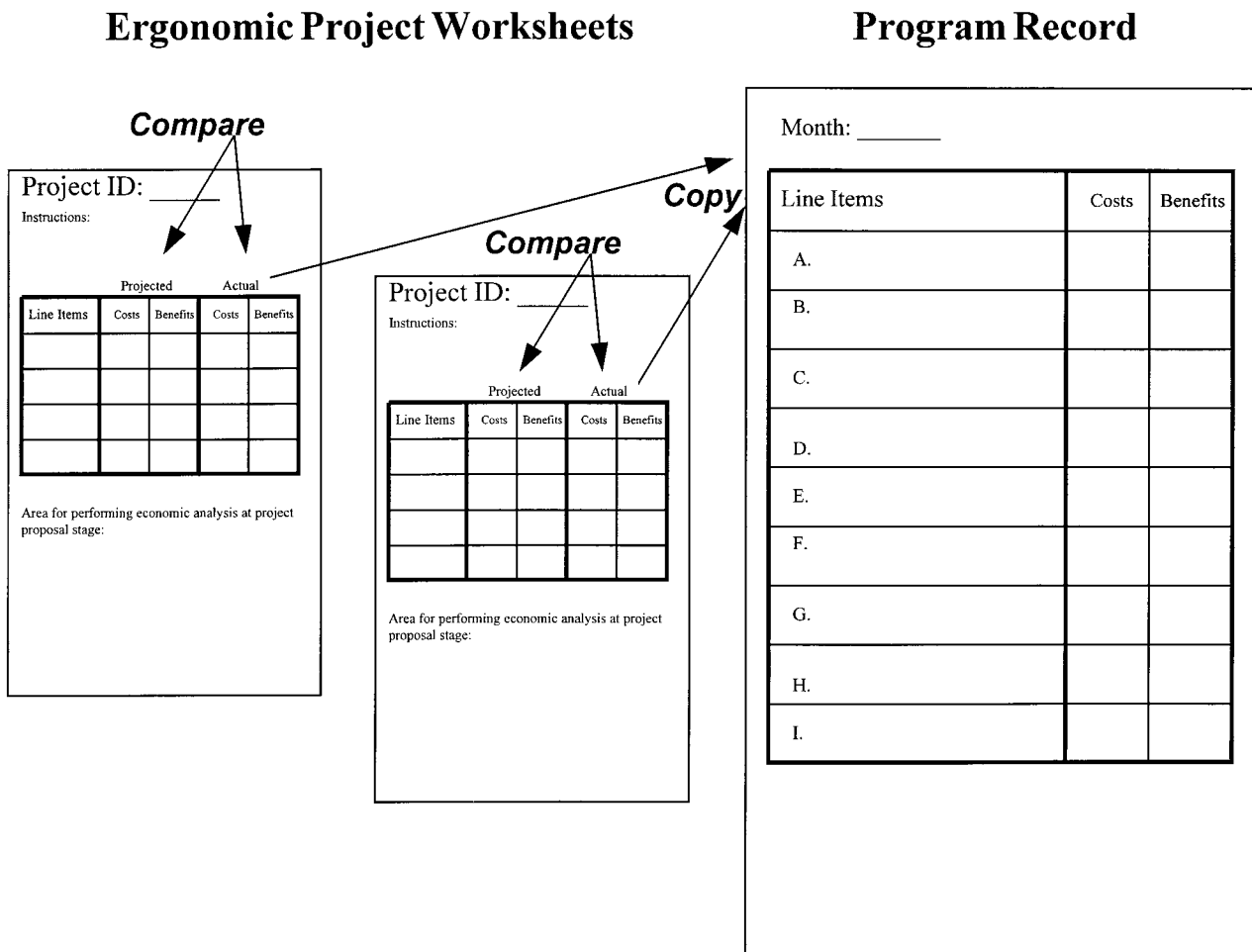

FIGURE 6.2 Information flows from individual Ergonomic Project Worksheets to the Program Record.

Program Record

The costs and savings included in this analysis method are primarily those discussed in Konz (1995), Oxenburgh (1997), Andersson (1992a), and Andersson (1992b), although modifications have been made to some of their methods and cost definitions. Additionally, items specifically associated with the ergonomics program and team have been added. Refer to Table 6.1 when proceeding through the discussion that follows.

A. Ergonomics program — regular charges. These are costs associated with the maintenance and day-to-day functioning of the program.

1. *Meetings.* The ergonomics team meets on a regular basis. While in these meetings, members are not working on production; therefore, lost production costs are associated with the meetings. Overhead charges may be assessed as well, for indirect labor for nonproduction employee members. Line items and suggested calculation method:

- a. Lost production

$$C_{LP} = W_h \times T_h \quad (1)$$

where

C_{LP} = Cost of lost production, \$

W_h = Hourly wage rate¹, \$/hr

T_h = Time (length of meeting), hr

- b. Other

2. *Training.* Ergonomics training, specific to an employee's responsibilities, is a fundamental element of an ergonomics program. Lost production, consultant fees, and materials are all costs associated with training. The costs of training for indirect labor (such as engineers and managers) should also be accounted for. Line items and suggested calculation method:

- a. Lost production: calculated per Equation 1, above, substituting length of training time for meeting time
- b. Trainer/consultant costs
- c. Materials: books, pamphlets, etc.
- d. Other

3. *Medical management.* Medical management is a key element to an ergonomics program. Any costs that can be directly attributed to this element, as well as any savings, should be accounted for. One example would be contracting with a physical therapist to work onsite for a half day each week to answer employee questions or assist with treatment regimens. Lost production associated with these visits should also be accounted for. If as a result of the ergonomics program, a facility eliminated the practice of providing back belts on demand to workers, the cost savings from that decision should be accounted for. Line items and suggested calculations:

- a. PT/OT, nurse (for effort specific to program)
- b. Lost production: calculated per Equation 1, above, substituting length of consultation or treatment session for meeting time.
 - i. Consultation
 - ii. Treatment
- c. Back belts, wrist supports purchases: If these items are purchased in conjunction with the program, the line item would appear as a cost. If these items are no longer purchased as a result of the program, the elimination of the average monthly expenditure on these items should be recorded as a savings.
- d. Other

¹In all calculations where wages appear, include pay and fringe benefits. However, do not include overhead (burden). That is treated in item G of the EPW.

B. Turnover and Training/Replacement. These are the costs associated with replacing workers due to turnover (Andersson, 1992a). Companies may have standardized these costs for various classifications of workers. Replacement costs, per Andersson (1992a), include costs of acquiring and developing new employees, as well as costs associated with separation of departing employees.

1. *Acquisition costs.* These are the costs associated with acquisition of new employees, and may include costs associated with personnel recruitment, selection, and/or hiring. Recruitment costs include costs such as advertising, agency fees, brochures, travel, meals, and administrative costs. Selection costs include interviewing, pre-employment testing, and administrative costs. Hiring costs might include costs such as medical screening and administrative costs. Line items:
 - a. Recruitment
 - b. Selection
 - c. Hiring
2. *Development costs.* These are the costs associated with bringing an employee “up to speed” on a job which an employee has left. The most common costs associated with development are associated with orientation, on-the-job-training, and off-the-job training. Orientation costs might include costs for materials and trainers. On-the-job training would result in a loss of productivity due to lack of expertise of the new employee and possibly the need for overtime in order to compensate for lost production. Off-the-job training costs might include materials, costs for trainers, and loss of productivity while in training sessions. Line items and suggested calculations:
 - a. Orientation
 - b. On-the-job training
 - i. Lost production due to lack of proficiency

$$C_{LC} = W_d \times (1 - \text{eff}) \times T_d \quad (2)$$

where

C_{LC} = Lost production due to learning curve effects, \$

W_d = Daily wage rate (includes benefits), \$/day

eff = New employee performance, relative to seasoned (range 0-1)

T_d = Time (learning period in days), days

- ii. Overtime to compensate for lost production

$$C_{OT} = W_{Eh} \times T_h \quad (3)$$

where

C_{OT} = Cost of overtime, \$

W_{Eh} = Hourly excess wage rate for overtime, \$/hr

T_h = Time (number of overtime hours), hr

- c. Off-the-job training (formal instruction away from the workstation)
 - i. Trainer and material costs
 - ii. Lost production: Calculate per Equation 1
 - iii. Overtime to compensate for lost production: Calculate per Equation 3
3. *Separation costs.* Typical costs associated with the departure of an employee include severance costs, reduced productivity, and open position costs. Severance costs include compensation, settlement, or benefits paid to employee upon departure from company. Productivity may be reduced prior to employee’s departure (from employee and from co-workers). Open position costs might include overtime for other employees to make up for the vacant position, or lost productivity if lost productivity results in income loss. Line items and suggested calculations:

- a. Severance
- b. Productivity decrement (similar to calculation in Equation 2)
- c. Open position
 - i. Lost production

$$C_{LPO} = W_d \times T_h \quad (4)$$

where

C_{LPO} =Cost of lost production due to open position, \$

W_d =Daily wage rate², \$/day

T_d =Time (number of day position remains open), day

- ii. Overtime to compensate for lost production: Calculate per Equation 3.

C. Absenteeism. Costs associated with work absences that are both work-related and associated with ergonomic hazards of the job are referred to as absenteeism costs (Andersson, 1992a). They include workers' compensation costs, medical expenses, and replacement costs (Andersson, 1992a). Note that sick days (nonrecordable lost time days) may also be reflective of poor ergonomic conditions, and, therefore, might be expected to respond to ergonomic modifications. However, rather than making this assumption, sick absence data should be tracked before and following modifications, in order to determine: (1) if this is the case, and (2) what standardized value might be used in economic analyses of proposed capital expenditures in the future.

1. *Workers' compensation costs:* Monies paid to ill or injured employees during their absence from work are accounted for here. These may be represented by or substituted with insurance fees. Also include payroll taxes, benefits, etc. Line items:
 - a. Wages (including taxes, fringe)
 - b. Insurance charges or fees
2. *Medical expenses:* These are expenses associated with treatment for illness or injury, and may also be substituted with insurance fees. Line items:
 - a. Payments to providers
 - b. Insurance charges or fees
3. *Replacement costs:* Review costs associated with turnover (Category B, described above) for costs associated with loss of production, overtime for other employees, hiring of replacement or temporary employee, etc. Line items: Refer to Turnover and Training (Category B, above)

D. Productivity. Productivity may be adversely impacted by poor work conditions, or positively impacted by ergonomic controls. Equipment that requires frequent maintenance or adjustment may reduce productivity when it is running (suboptimally) and when down for maintenance or adjustment. Productivity changes can be estimated from predetermined time systems, historical records, experience, or from pilot time studies. Actual changes can be determined from time study, work sampling methods, or production records. In calculating productivity savings, actual production time requirements should be used in assessing productivity changes, rather than standard times unless production rate is equivalent to the standard. Time standard allowances are one place to look for improvements in productivity. Often allowances are built in for less than optimal working conditions (such as poor lighting or strenuous, fatiguing work). Modifications that target allowances are likely to improve productivity. Line items and suggested calculation method:

²In all calculations where wages appear, include pay and fringe benefits. However, do not include overhead (burden). That is treated in item G of the EPW.

1. *Permanent changes in productivity*

$$S_U = W_h \times \Delta_{\text{eff}} \times T_{\text{RU}} \quad (5)$$

where

S_U = Savings, \$/production unit

W_h = Hourly wage rate, \$/hr

Δ_{eff} = Improvement in production time (percentage time reduction from reference time)

T_{RU} = Reference time/unit

2. *Temporary changes in productivity:*

- a. Lost production time for maintenance, repair, or adjustment. Refer to Equation 1.
- b. Overtime to compensate for down time. Refer to Equation 3.

E. Rework and Scrapped Product. These are costs associated with products that must be reworked, reduced to salvage, or written off (Andersson, 1992a). Per piece costs and rates are required to perform the calculations.

1. *Rework.* Direct labor and material costs, and costs associated with making up for lost productivity, such as overtime charges; extra costs associated with warranty claims may contribute to rework costs. An inventory fee may be charged if product is stored for a significant period of time before being reworked. Line items and suggested calculations:
 - a. Direct labor

$$CR_{\text{dl}} = W_h \times R_{\text{pu}} \times T_{\text{ru}} \quad (6)$$

where

CR_{dl} = Cost of direct labor for rework, \$/production unit

W_h = Hourly wage rate, \$/hr

R_{pu} = Rework rate, units to rework/units of production

T_{ru} = Time for rework, hr/unit

- b. Lost production or overtime: Refer to Equations 1 or 3.
 - c. Direct materials
 - d. Other
2. *Scrapped goods.* Direct labor and material costs, less salvage value of materials; costs associated with making up for lost productivity, such as overtime charges, contribute to the costs of scrapped goods. Overhead charges may also be included. Line items:
 - a. Direct labor cost
 - b. Overtime
 - c. Direct material loss less salvage value
 - d. Other

F. Wages. Wage costs to the company include wages for productive work hours (no absences or vacation hours included), and additional charges associated with wages (taxes, benefits). Personnel and administrative charges are included in the methodology of Oxenburgh (1997). They are included as a separate line item in the current method, per recommendation of Konz (1995), for the following reasons: (1) it is unlikely that these charges will change as a result of ergonomic changes, and (2) savings may be unfairly inflated by working with a larger labor cost. Line items:

1. Direct labor, including benefits, taxes, insurance, etc.
2. Supervisory and administration charges

G. Overhead. Included in overhead that might be likely to be affected by ergonomics-related changes would be items such as utility costs, insurance fees, and OSHA fines. Activity-based costing is promoted as a method for allocating overhead costs (Riel and Imbeau, 1995).

H. Direct materials. Any changes in direct material costs not included elsewhere would appear here.

I. One-Time Costs. These costs are typically incurred in conjunction with capital expenditures (investments), and include costs for equipment, jigs and fixtures, installation, engineering time, and operator training costs (refer to items B.2.b and c for costs associated with training). Capital expenditures are discussed in more detail in the section on project calculations. Line items:

1. Equipment
2. Jigs and fixtures
3. Installation
4. Engineering time
5. Operator training
6. Other

Supporting Data

In order to estimate or calculate costs and savings for projects, information may be required on several of the following items (Andersson, 1992b):

- Total hours, and hours categorized as productive vs. nonproductive (absences, vacation, training, illness, injury): for machine(s), process(es), individual operator(s)
- Wage rates
- Direct and indirect labor hours for a product or operation
- Labor hours and costs associated with specific absences, by illness or injury, by department, by job, by time period
- Turnover by department or job, by time period
- Accounting of rework and scrapped material, at particular stages of production
- Time standards

Data Sources. Simpson and Mason (1995) provided suggestions for locating these supporting data. When values are not available in house, they either need to be calculated from available data, or, if applicable, industry standard values might be used.

- *Personnel department:* Costs and/or rates of absenteeism, turnover, training, workers' compensation.
- *Industrial or process engineering:* Allowances, time standards (and assistance with time standard estimates for proposals), production variation, rejection rates, inspection costs, excessive downtime, equipment maintenance costs and time requirements, scrap and rework rates and costs. Simpson and Mason (1995) provided a 30% of ownership cost rule-of-thumb estimate for machine maintenance.
- *Medical department:* Nature and severity of illnesses and injuries, nature and length of health-related absences.

Additionally, Simpson and Mason (1995) identified other resources within a facility upon which the ergonomics team may draw information or support:

- *Safety department:* To help with locating areas within the plant with ergonomic hazards.
- *Medical department:* Type and frequency of minor injuries, type and frequency of reported musculoskeletal-related symptoms.

Simpson and Mason (1995) also suggested execution of an ergonomic survey, to obtain information of job satisfaction, risk-taking behaviors, and near misses, any or all of which may point to areas in the facility in need of the attention of the ergonomics team.

Sources of data and calculations used in the analysis should be clearly documented. This facilitates future analyses, keeps analyses on common ground, and facilitates retracing steps if questions arise, especially if proposal estimates and actual project costs or savings do not match. Riel and Imbeau (1995) recommended development of a three-component support system that would provide decision support to personnel involved in ergonomic investment decision-making. The system included a model of costs (which costs to include; how they are analyzed; how they behave), a safety information system (a database of injury and risk factor information), and an appropriate user interface (once the system is established, computerize it in order to facilitate its use).

Project Evaluations

Ergonomics team activity is often project based. Each proposed project should be evaluated before being undertaken, not only in terms of ergonomic benefits, but in economic terms as well. Methods for performing economic analyses on small projects, large projects, and light duty assignments are examined in this section. Simpson and Mason (1995) cautioned analysts to be conservative in their estimations of benefits from proposed projects. They found it preferable to underestimate, rather than overestimate, in order to reduce the likelihood of implementing projects that turn out to be poor investments of company resources.

Small Projects. Small projects may be evaluated by using payback period analysis as an accept/reject criteria, recognizing that this does not account for the time value of money. Payback period is simply the length of time required for benefits for equal initial project costs, without consideration of interest. If savings are equivalent in each time period, then Equation 7 can be used to calculate payback period.

$$PB = C/S \quad (7)$$

where

PB = payback period, in months, years, etc. corresponding to S

C = one-time project cost, \$

S = periodic savings (or income), per month, year, etc.

Capital Expenditures. Projects that require significant monies to be spent at the beginning, with the expectation of benefits (savings, income, or both) in the future are referred to as capital expenditures. There are several ways to evaluate whether or not a proposed project would be a good investment of a company's funds. The first assessment is simply a go-no go decision, in which estimated costs are compared with estimated future benefits (income or savings). If costs exceed benefits, then from an economic standpoint, the project would not be a sound investment of the firm's money. If the benefits at least equal the costs and the company has limited funds, then the project should also be compared with other projects in which the company could invest its resources. If the company cannot undertake all the acceptable projects, then, according to economic theory, the costliest project that will provide the acceptable *incremental* return, among all acceptable projects, should be chosen.

In performing capital expenditure evaluations, the *time value of money* (interest rates and acceptable rate of return for the company) should be considered for projects that have extended lives. That is where benefits may not be realized immediately, where benefits may be realized for an extended period of time, or where there are recurring costs associated with a project (for example: periodic replacement of parts, or maintenance costs).

There are four popular methods for performing economic analysis of capital projects: Net Present Worth determination (NPW), Net Annual Worth determination (NAW), Benefit/Cost ratio (B/C), and

TABLE 6.3 Economic Analysis Methods

Method	Calculation	Condition	Decision Criteria
NPW	$NPW^* = \frac{A[(1+i)^n - 1]}{i(1+i)^n} - C$	Independent alternatives	Select those with $NPW > \$ 0$
		Dependent alternatives	Select alternative with maximum NPW
NAW	$NAW = A - \frac{Ci(1+i)^n}{[(1+i)^n - 1]}$	Independent alternatives	Select those with $NAW > \$ 0$
		Dependent alternatives	Select alternative with maximum NAW
B/C	$\frac{NPWB}{NPWC} \quad \text{or} \quad \frac{NAWB}{NAWC}$	Independent alternatives**	Select those with $B/C \geq 1$
ROI	***	Independent alternatives**	Select those with $ROI \geq MARR$

where

A = savings or income that remains the same each year

i = interest rate (company's MARR), annual, in decimal format (ex for 20% use 0.20)

n = project life, years

C = project cost, assumed to be single cash outlay at beginning of project

NPWB=Net Present Worth of Benefits (savings or income) = NPW + C

NPWC=Net Present Worth of Costs = C

NAWB=Net Annual Worth of Benefits = A

NAWC=Net Annual Worth of Costs = A — NAW

* If savings or income is not projected to be the same in each year calculate NPW as follows:

$NPW^* = \sum (S_t / (1+i)^t) - C$, where the summation extends over the life of the project. S_t is savings or income for any particular year t of the project.

** For the case of dependent alternatives, refer to one of the books mentioned in the For Further Information section of this chapter.

*** ROI is determined through the use of any of the following equations. ROI is that i that satisfies the equations, and is determined through trial and error.

$$NPWB - NPWC = 0$$

$$NAWB - NAWC = 0$$

$$NAWB/NAWC = 1$$

$$NPW = 0$$

Return-on-Investment (ROI). NPW and NAW are generally easier methods to apply if a set of mutually exclusive alternatives is assessed, because pairwise comparisons among the alternatives occurs automatically. Both methods combine all costs, income, and savings for a proposal into a single monetary value that is dependent upon the company's (or analyst's) minimum acceptable rate of return (MARR). The largest positive NPW or NAW value identifies the best alternative. B/C and ROI methods are easily applied in situations where independent alternatives are assessed (where selecting one proposal does not influence the opportunity to select any other), but involve multistep analysis processes when mutually exclusive proposals are evaluated. B/C ratio and ROI provide intuitively appealing outputs and criteria. For analysis of independent projects, any project with a B/C that meets or exceeds 1 is accepted. An interest or investment rate is the outcome of ROI analysis. If the rate is acceptable, the proposal should be undertaken. Equations for performing each of these analyses are presented in Table 6.3, along with decision criteria and assumptions regarding application.

Andersson (1992a) recommended checking the stability of the outcome of any economic analysis by performing sensitivity analyses, that is, determining how the outcome of the analysis is affected by changes in the estimated values used in the original calculation. This will provide a view of the stability of the projected outcome of the project.

Light Duty Evaluation. The following calculation can assist in the economic assessment of a light duty program, or in the decision to bring an individual employee back to work on light duty. This assessment is based, in part, on calculations in Ritzel and Allen (1988).

$$C_{LD} = \left\{ [P_w \times V - (P_w - P_a)] \times D \right\} + C_m \quad (8)$$

where

C_{LD} = Cost of light duty assignment, \$

P_w = Regular wage rate for employee, including benefits and taxes, \$/day

V = Value to light duty work, relative to regular work, percentage

P_a = Payments to worker when on sick absence³, \$/day

D = Number of days on light duty

C_m = Costs of modifications to workplace, \$

Medical costs should also be accounted for, including rehabilitation costs. A review of Table 6.1 and company policies regarding early return to work may identify other line items that should be included in this evaluation.

6.3 Method Application: Sample Calculations for Evaluating and Tracking Costs and Benefits of Proposals, Projects, and Programs

A series of examples is presented to illustrate the application of the equations presented in the previous section. The reader is reminded that the primary purpose for the chapter is to present a model of cost categories, and that specific equations are only suggested methods for obtaining line item values for the Program Record and Ergonomic Project Worksheets. Companies may have established methods for estimating many of these line items. Additionally, the references that are cited throughout the chapter may provide some alternative calculation methods that are better suited for a particular company.

Example 1: A. Ergonomics Program — Ergonomics Team Meetings

Company XYZ's ergonomics team meets once a week for 1 hour. The team consists of three hourly operators (at \$10/hr), one engineer, the plant nurse, the plant manager, the human resources manager, and one first line supervisor. Accounting, the plant manager, and the HR manager have decided that a charge of \$25/hr per nondirect team member is appropriate. The cost of each meeting would then be calculated as follows, using Equation 1:

$$C_{LP} = W_h \times T_h$$

$$\begin{aligned} \text{Meeting cost} &= C_{LP\text{-direct labor}} + C_{LP\text{-indirect labor}} \\ &= (\$10/\text{hr} \times 1 \text{ hr/meeting} \times 4 \text{ meetings/month} \times 3 \text{ operators}) + \\ &\quad (\$25/\text{hr} \times 1 \text{ hr/meeting} \times 4 \text{ meetings/month} \times 5 \text{ members}) \\ &= \$620/\text{month} \end{aligned}$$

³Note that this cost could be workers' compensation, benefits, and taxes paid directly by the company, or this cost could be a portion of the insurance premium the company pays out that can be fairly attributed to the employee's absence.

Example 2: B. Turnover and Training — On-the-job training

Operation E has an annual turnover rate of three employees. The hourly wage cost to the company is \$16/hr (includes benefits, taxes); employees work 8 h per day. It takes about 90 days for an employee to become fully productive on this job. Over the 90 days, a new employee typically performs at about 70% of the efficiency of a seasoned employee. The annual cost of this turnover would be calculated as follows per Equation 2:

$$C_{LC} = W_d \times (1 - \text{eff}) \times T_d$$

$$\begin{aligned} \text{Annual cost/replaced employee} &= (\$16/\text{hr} \times 8 \text{ hr/day}) \times (1 - .7) \times 90 \text{ days} \\ &= \$3456/\text{employee}/\text{year} \end{aligned}$$

Therefore, the annual cost to replace three employees would be \$10,368 (= \$3456 × 3).

If turnover were reduced to one employee per year, the savings attributed to the ergonomics program would be calculated as follows:

$$\begin{aligned} \text{Savings} &= \text{Cost}_{\text{after change}} - \text{Cost}_{\text{before change}} \\ &= -\$3456 - -\$10,368 = \$6912/\text{year} \end{aligned}$$

Example 3. B. Turnover and Training — Overtime to compensate for lost production

Management estimates that Operation K runs ten Saturdays each year to compensate for reduced production associated with training new employees. Hourly wage is \$18/hr; overtime is time and a half. Two operators are required. Use Equation 3 to calculate overtime costs.

$$C_{OT} = W_{Eh} \times T_h$$

$$\begin{aligned} \text{Cost} &= \$9/\text{hr} \times 8 \text{ hr/day} \times 10 \text{ days} \times 2 \text{ employees} \\ &= \$1440/\text{year} \end{aligned}$$

Assume employees were able to learn the job more quickly, as a result of changes in training methods or production methods, for example. If new employees were able to learn the job more quickly, which resulted in a reduction of overtime to only four Saturdays per year, the following recurring savings could be attributed to the ergonomics program:

$$\begin{aligned} \text{Savings} &= \text{Cost}_{\text{after change}} - \text{Cost}_{\text{before change}} \\ &= -\$576 - -\$1440 = \$864/\text{year} \end{aligned}$$

Example 4: B. Turnover and Training — Costs due to an open position

Part a: Lost production due to an open position. Operation G loses 3 days worth of production for each turnover due to a temporary vacancy. This production is not made up through overtime. The turnover rate is 4 employees/year. The hourly wage cost to the company is \$11/hr (includes benefits, taxes); employees work 8 h per day. Lost production could be calculated using Equation 4.

$$C_{LPO} = W_d \times T_h$$

$$\begin{aligned} \text{Cost of lost production/turnover} &= (\$11/\text{hr} \times 8 \text{ hr/day}) \times 3 \text{ days} \\ &= \$264/\text{turnover} \end{aligned}$$

Therefore, the total cost of lost production for turnover rate of four per year would be \$1056 (= \$264 × 4). If turnover were reduced to 2 employees per year, the savings attributed to the program would be calculated as follows:

$$\begin{aligned} \text{Savings} &= \text{Cost}_{\text{after change}} - \text{Cost}_{\text{before change}} \\ &= -\$528 - -\$1056 = \$528/\text{year} \end{aligned}$$

Part b. Overtime to compensate for lost production. If, instead, management opts to utilize overtime to make up for the lost production, costs and savings would be calculated as follows, based on the same turnover rate reduction from 4 per year to 2, an hourly wage cost of \$11/hr, and 3 days of overtime per turnover. Using Equation 3,

$$C_{OT} = W_{Eh} \times T_h$$

$$\begin{aligned} \text{Savings} &= \text{Cost}_{\text{after change}} - \text{Cost}_{\text{before change}} \\ &= (\text{Hourly excess overtime rate} \times \text{hours} \times \text{days} \times \text{number of turnovers})_{\text{after change}} - \\ &\quad (\text{Hourly excess overtime rate} \times \text{hours} \times \text{days} \times \text{number of turnovers})_{\text{before change}} \\ &= (\$5.50/\text{hr} \times 8 \text{ hr} \times 3 \text{ days} \times 2 \text{ turnovers}) - \\ &\quad (\$5.50/\text{hr} \times 8 \text{ hr} \times 3 \text{ days} \times 4 \text{ turnovers}) \\ &= -\$264 - -\$528 = \$264/\text{year} \end{aligned}$$

Example 5: C. Absenteeism

Department S has an average of 6 lost time back injuries per year. The company is self-insured, and so pays all medical and compensation to sick or injured employees. Average lost time for a back injury in this department is 10 days; average medical costs are \$5000. Absent workers are not replaced. Compensation costs are 2/3 the usual \$9/hr labor cost.

$$\begin{aligned} \text{Annual costs/back injury} &= \text{Cost}_{\text{compensation}} + \text{Cost}_{\text{medical}} + \text{Cost}_{\text{lost production}} \\ &= \$6/\text{hr} \times 8 \text{ hr/day} \times 10 \text{ days} + \\ &\quad \$5000 + \\ &\quad \$9/\text{hr} \times 8 \text{ hr/day} \times 10 \text{ days} \\ &= \$480 + \$5000 + \$720 = \$6200/\text{back injury} \end{aligned}$$

Therefore, total cost for six back injuries in a year would be \$37,200 (= \$6200 × 6). A proposed change in methods is expected to reduce the number of back injuries to 3 per year. The expected savings would be:

$$\begin{aligned}\text{Savings} &= \text{Cost}_{\text{after change}} - \text{Cost}_{\text{before change}} \\ &= -\$18,600 - -\$37,200 = \$18,600\end{aligned}$$

Example 6: D. Productivity

Production was 80 units per 8 hours for Operation F (10 units/hour, or 0.1 hour/unit). A 13% reduction in per unit production time was realized following methods improvements. Direct labor costs are \$12/hr. Using Equation 5,

$$\begin{aligned}S_U &= W_h \times \Delta_{\text{eff}} \times T_{\text{RU}} \\ \text{Savings per unit} &= \$12/\text{hr} \times 13\% \times 0.1 \text{ hr/unit} \\ &= \$0.156/\text{unit}\end{aligned}$$

Annual savings would be based on the number of units produced.

Example 7. E. Rework and Scrapped Product — Rework — Direct labor costs/savings

Records show that on average 1 unit in 50 requires rework in Department C. The production rate is 800 units/day; labor costs are \$10/hr. On average rework time is 1 min/unit. Using Equation 6,

$$CR_{\text{dl}} = W_h \times R_{\text{pu}} \times T_{\text{ru}}$$

$$\begin{aligned}\text{Rework direct labor cost} &= \text{labor cost} \times \text{rework rate} \times \text{time requirement} \\ &= \$10/\text{hr} \times 1 \text{ unit}/50 \text{ production units} \times 1 \text{ min/unit} \times 1 \text{ hr}/60 \text{ min} \\ &= \$0.0033/\text{production unit}\end{aligned}$$

The annual rework cost for a production rate of 800/day, running 250 days per year would be \$667 (= \$0.0033 × 800 × 250). Note that if a production worker is pulled off production work to perform rework tasks, lost production should also be accounted for.

Example 8: E. Rework and Scrapped Product — Scrapped Product

Records show that on average 1 unit in 400 is scrapped in Department C. The production rate is 800 units/day; labor costs are \$10/hr; direct material costs are \$1.20/unit. Salvageable materials are valued at \$.30/unit

$$\begin{aligned}\text{Scrapped product cost/unit} &= (\text{direct labor} + \text{direct materials} - \text{salvage value}) \\ &= [(\$10/\text{hr} \times 8 \text{ hr/day}) / (800 \text{ units}) + \$1.20/\text{unit}] - \$0.30/\text{unit} \\ &= \$1.00/\text{unit}\end{aligned}$$

The annual scrapped cost for a production rate of 800 production units/day, running 250 days per year would be \$500 (= \$1.00 × 2 scrapped units/day × 250 days).

Example 9: Small Project

The purchase of tool belts for 10 furniture company employees is expected to reduce the need for employees to repeatedly walk between the line and their work benches for various hand tools they use in the clean-up and repair department. Tool belts cost \$12 each, and are expected to last one year. Productivity is expected to increase by 1%. Wage costs are \$15/hr to the company. Average time per unit is currently 20 min. Using Equation 7,

$$PB = C/S$$

$$\text{Project cost, } C = \$12/\text{belt} \times 10 \text{ belts} = \$120$$

$$\text{Savings/unit} = \$15/\text{hr}/\text{employee} \times 10 \text{ employees} \times 1\% \times 0.33 \text{ hr/unit} = \$0.495/\text{unit}$$

$$\text{Annual savings, } S = \$0.495/\text{unit} \times 24 \text{ units/day} \times 250 \text{ days/yr} = \$2970$$

$$\text{Payback period, } PB = \$120/\$2970 = 0.04 \text{ years, or about } 1/2 \text{ month.}$$

Example 10: Capital Expenditure

Scenario. BVB Company is evaluating the purchase of a lift table for a particular location in its plant. The rate of occurrence of back injury at that location averages one in three years. The average cost of a back injury is \$5200, per the company's insurance carrier and the human resources director (Category C. Absenteeism). The lift table will cost \$3200 (Category I. One-Time Costs), and is expected to last for 5 years, with proper maintenance (expected maintenance costs of \$500/year, charged under Category G. Overhead). The lift table is expected to improve productivity by 5% (current production rate is 40 units per hour, 7 hours per day, 250 days per year; wages for employees at that location are calculated at \$15/hr; appears under Category D. Productivity). To be conservative, these are the only benefits that are used to evaluate the purchase. If the company has established an MARR of 10%, should the lift table be purchased, based on economic projections?

Solution. Economic decision analysis always involves comparison of alternatives, even if there is apparently only one proposal, because Do Nothing is always considered an alternative.

First consider the Do Nothing option. If back injury rate is one in three years, with an average cost of \$5200, the annual cost of a back injury can be assessed as \$5200/3, or \$1733/year. Use a cash flow diagram to depict this alternative (refer to Figure 6.3a).

Next, evaluate each of the applicable line item categories for the lift table alternative. The initial cost is \$3200, but maintenance costs of \$500/year are also anticipated. Productivity is anticipated to improve by 5%. Using Equation 5,

$$S_U = W_h \times \Delta_{\text{eff}} \times T_{\text{RU}}$$

$$\text{Savings per unit} = \$15/\text{hr} \times 5\% \times (1 \text{ hr}/40 \text{ units}) = \$0.0188/\text{unit}$$

$$\text{Annual savings} = \$0.0188/\text{unit} \times 280 \text{ units/day} \times 250 \text{ days/yr} = \$1316/\text{yr}$$

The costs and benefits associated with the lift table alternative are presented in Figure 6.3b. Figure 6.3c combines the two, and is the cash flow diagram that will be analyzed. Each of the four methods of analysis will be demonstrated. A project life of 5 years will be used, since that is the life of the table.

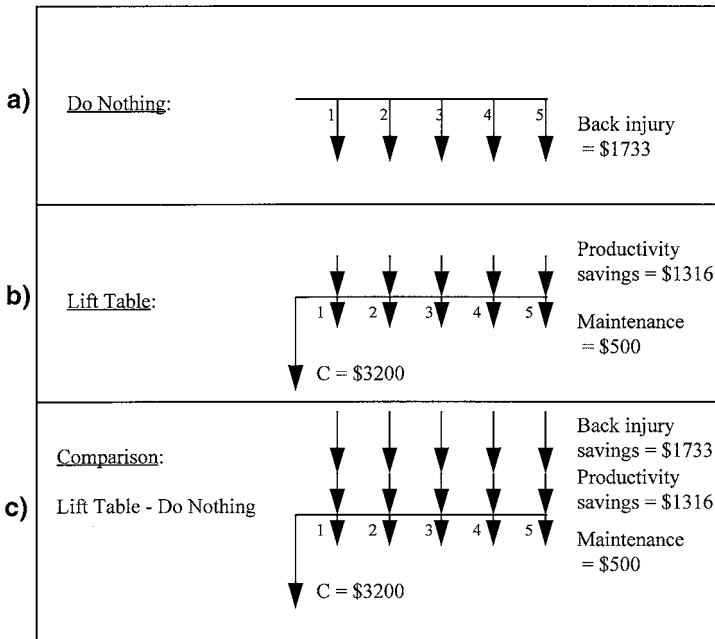

FIGURE 6.3 Cash flow diagrams for economic assessment of a) Do Nothing alternative, b) lift table purchase, and c) comparison of lift table purchase to Do Nothing alternative.

$$\begin{aligned}
 NPW &= PW_{\text{savings in back injury costs}} + PW_{\text{productivity savings}} - PW_{\text{lift table cost}} - PW_{\text{maintenance costs}} \\
 &= 1733 \frac{[(1+i)^n - 1]}{i(1+i)^n} + 1316 \frac{[(1+i)^n - 1]}{i(1+i)^n} - 3200 - 500 \frac{[(1+i)^n - 1]}{i(1+i)^n}
 \end{aligned}$$

Setting $i = 10\%$, $n = 5$ years, results in an $NPW = \$6463$. Since NPW is greater than $\$0$, the project should be undertaken.

$$\begin{aligned}
 NAW &= AW_{\text{savings in back injury costs}} + AW_{\text{productivity savings}} - AW_{\text{lift table cost}} - AW_{\text{maintenance costs}} \\
 &= 1733 + 1316 - 3200 \frac{i(1+i)^n}{[(1+i)^n - 1]} - 500
 \end{aligned}$$

Setting $i = 10\%$, $n = 5$ years, results in an $NAW = \$1705$. Since the NAW is greater than $\$0$, the project should be undertaken.

B/C analysis can be performed with PW or AW calculations. Using AW , $i = 10\%$ and $n = 5$ years:

$$AWB = AW_{\text{savings in back injury costs}} + AW_{\text{productivity savings}} = 1733 + 1316 = 3049$$

$$AWC = AW_{\text{lift table cost}} + AW_{\text{maintenance costs}} = 844 + 500 = 1344$$

Therefore, $B/C = 3049/1344 = 2.3$. Since this exceeds 1, the project should be undertaken.

ROI analysis can be performed using any of several equations presented in Table 6.3. Using NAWB — NAWC = 0, determine by trial and error the i that satisfies the equation,

$$\begin{aligned} AW_{\text{savings in back injury costs}} + AW_{\text{productivity savings}} &= AW_{\text{lift table cost}} + AW_{\text{maintenance costs}} \\ 1733 + 1316 &= 3200 \frac{i(1+i)^n}{[(1+i)^n - 1]} + 500 \end{aligned}$$

i turns out to exceed 60%. Since $i \geq \text{MARR}$, the project should be undertaken.

6.4 Additional Metrics: Results-Oriented Statistics

A number of other metrics can be used to assess the effectiveness of an ergonomics program, including injury and illness rates, severity rates (referring to lost workdays or restricted workdays), absenteeism, productivity (described in units of production), and machine availability (which signals reduced downtime). Illness, injury, and severity rates are usually normalized to a standard, so that rates can be compared across departments or plants, even if numbers of employees or work hours vary across departments or plants. Equations for illness and injury rate calculation and for severity rate calculation appear in Equations 9 and 10, respectively.

$$IR = \frac{I \times 200,000 \text{ hrs}}{N_e \times H_a} \quad (9)$$

where

IR = Injury or illness rate normalized to 100 people working 2000 h per year

N_e = Number of employees in department or plant

H_a = Average number of hours worked per year per employee

$$SR = \frac{D \times 200,000 \text{ hrs}}{N_e \times H_a} \quad (10)$$

where

SR = Rate of days lost or restricted normalized to 100 people working 2000 h per year

D = Days lost or restricted

N_e = Number of employees in department or plant

H_a = Average number of hours worked per year per employee

Increased machine availability may be a goal of an ergonomics program. Improvement in equipment access can encourage regular maintenance activities and reduce repair time. Simpson and Mason (1995) presented an equation for calculating machine availability:

$$MA = \frac{MTBF}{MTBF + MTTR + MTPM} \quad (11)$$

where

MA = machine availability

MTBF = mean time between failure

MTTR = mean time to repair

MTPM = mean time for preventive maintenance

6.5 Concluding Remarks

In order to support the process of economic justification of health and safety (H&S) projects, including those related to ergonomics, Riel and Imbeau (1995) recommended developing a “comprehensive support system...” that included “a model of H&S costs, a safety information system, and a proper user interface, all of which make the analysis of H&S investments efficient and effective.” One element of that support system, a categorical model of cost and saving sources, was presented in this chapter. Suggestions for calculating those costs and savings were also provided. However, performing specific cost and savings calculations, using those equations or methods specific to a given facility, will depend upon the quality of information available within the facility. The effort to develop and implement a systems approach to ergonomics that includes provisions for supporting economic analysis will provide a sound foundation for an ergonomics program.

References

- Alexander, D.C. 1996. The ergonomics program report card. *Workplace Ergo.* (Jan/Feb):26.
- Andersson, E.R. 1992a. Economic evaluation of ergonomic solutions: Part I — Guidelines for the practitioner. *IJIE.* 10:161-171.
- Andersson, E.R. 1992b. Economic evaluation of ergonomic solutions: Part II — The scientific basis. *IJIE.* 10:173-178.
- DeKraker, M., Lindstrom-Hazel, D., Cooper, R., and Ambrosius, F. 1995. Ergonomic modifications: examining cost and effectiveness. *Work.* 5:123-131.
- Helander, M.G. and Burri, G.J. 1995. Cost effectiveness of ergonomics and quality improvements in electronic manufacturing. *IJIE.* 15:137-151.
- Hendrick, H.W. 1996. *Good Ergonomics is Good Economics.* 1996 HFES Presidential Address.
- Konz, S. 1995. *Work Design: Industrial Ergonomics*, 4th. Publishing Horizons, Inc., Scottsdale.
- Oxenburgh, M.S. 1997. Cost-benefit analysis of ergonomics programs. *AIHAJ.* 58(2):150-156.
- Riel, P.F. and Imbeau, D. 1995. Making the best ergonomics investment. *IIE Solutions.* (June):30-33.
- Ritzel, D.O. and Allen, R.G. 1988. Value of work — a way of evaluating a light duty program in a work setting. *Prof. Safety.* (Nov):23-25.
- Simpson, G. and Mason, S. 1995. Economic analysis in ergonomics, in *Evaluation of Human Work*, Ed. J.R. Wilson and E.N. Corlett, p. 1017-1037. Taylor & Francis, London.

For Further Information

A number of papers on economics and health and safety or ergonomics have appeared in the *International Journal of Industrial Ergonomics*.

What Every Engineer Should Know about Economic Decision Analysis by D.S. Shupe, and *Engineering Economic Analysis* by D.G. Newman are useful references on economic analysis methods.

7

Economic Justification of the Ergonomics Process

7.1	Background.....	7-1
7.2	Management Duties in a Corporation	7-2
7.3	Intangible Benefits	7-2
7.4	Tangible Information.....	7-3
7.5	Cost Justification Methods.....	7-3
	Benefit/Cost Ratio • Payback Period • Losses vs. Goods Sold • Present Value (Time Value of Money)	
7.6	How Do You Determine the Full Cost of an Injury?	7-6
	Cost of Replacement Workers Lowered Productivity and Quality • Increased Supervisory Requirements • Training	
7.7	How Do You Predict Future Injuries?	7-9
7.8	What Other Costs Should You Consider?	7-9
7.9	Conclusions	7-10

David C. Alexander
Auburn Engineers, Inc.

Thomas J. Albin
3M Center

7.1 Background

This chapter will present some basic thoughts and information on how to justify ergonomics activity from a corporate perspective. Ergonomics, as a term, is frequently perceived as solely concerned with efforts to control work-related musculoskeletal disorders; yet in its true sense, it is the technology of enhancing all facets of human performance in the workplace, and is not limited to just safety, health, and comfort. An ergonomist would be equally at home with issues such as improving product quality or decreasing the likelihood of errors through the application of ergonomic techniques.

Many individuals charged with implementing ergonomics programs in corporations are unfamiliar with the culture of business organizations in general and may often be unfamiliar with the culture within their own corporation in particular. Accordingly, a brief introduction to some concepts within corporate culture may be beneficial.

A business corporation is a legal entity that resembles a person. Its reason for being is to generate profits for its shareholders. It may enter into contracts or litigation. It is comprised of a number of individuals who work together toward a common goal.

When you propose an action, you have done so because you perceive a need to change something, generally in order to improve it. You justify doing this because there is some added value in achieving the desired goal. Because there is often great difference in what is valued among individuals, you must persuade all those who control the resources you wish to employ so that they will also value the end

results sufficiently to devote resources to them. It must be understood that management is not the only resource controller within a corporation.

Since resources are limited, you will find yourself in competition with other proposals which seek to employ the same resources that you are requesting. You must make the case that your proposal outweighs the others, or find a way to combine your proposal with others to make joint use of the resources in order to achieve mutual goals. As an example of how such goals may make use of the resources in order to achieve mutual goals consider the following example.

Production equipment was installed in a factory without sufficient attention paid during design and construction to health and safety issues. A plant health and safety team refuses to allow the equipment to be run until several deficiencies are corrected. As a result, the equipment sits on the plant floor for two weeks until the corrections are made. The manufacturing manager must absorb the cost of this equipment during this time without the offset of income from product manufactured, has to rearrange product delivery schedules, pay for raw materials held in stock, etc.

If this situation occurs frequently within a corporation, it is to the mutual advantage of the health and safety function and the manufacturing function to ensure that health and safety issues are addressed before the production equipment reaches the production facility. In fact, economics will suggest that these issues are most efficiently addressed when the production equipment is in the concept phase, rather than when it has already been built. While the benefit of this combined effort is seemingly obvious, the benefit may not always be so clear. How can you build a case to convince management that a course of action offers benefits?

7.2 Management Duties in a Corporation

Managers of a corporation have a number of duties to the corporation, which have been classified under the headings of loyalty, obedience, and due care.¹ They incur personal liability for failure to perform those duties, as well as potentially being subjected to fines or other penalties set by law if they break a law. Of these responsibilities, obedience and due care have direct bearing on the justification of ergonomics programs.

Obedience. Corporate managers have a responsibility to ensure that the corporation obeys the law. This is sometimes referred to as managing for compliance. Consequently, a manager would be expected to implement a recommendation for action which would enable a corporation to comply with a law or regulation in the workplace.

Due Care. A manager is expected to use good judgment. This judgment is to be exercised in determining actions that affect the well-being of the corporation. Courts have generally held the standard of behavior expected as that of a normally prudent person. Since the business of business is business, a reasonably prudent person would be expected to act in a financially responsible manner. A corporate manager is expected and required to act in a financially responsible manner. There are other things which, although less tangible than finances, materially affect the well-being of a corporation. A corporation is, for example, generally seeking to both act as, and be seen as, a good citizen. It will place great value on its reputation.

Responsibilities of an Ergonomist. In addition to the responsibility to point out regulatory requirements, an ergonomist must be able to make a case for the action which he/she proposes. This justification may be based on tangible benefits such as cost savings, intangibles such as corporate reputation, or some combination of both. The justification may be for a specific project, or for a corporation-wide effort.

7.3 Intangible Benefits

While corporations may not totally agree with Shakespeare that, "He who steals my purse steals trash," they are certainly in agreement with him regarding the loss of their good name. There is often a sense of shared purpose or *esprit de corps* among all employees of a company. Certainly no manager worthy of the responsibility would intentionally seek to injure or place his employees at risk. Consequently, it

may be possible to justify some programs because they are “the right thing to do.” On the flip side, if such programs are regarded as nice to do, then they may be limited and not realize their full potential for mutual benefit to both employees and the company.

7.4 Tangible Information

An ergonomist will typically need to utilize tangible information regarding the way the corporation is conducting its business in order to build a case. A common starting point is to examine the potential benefit of reducing the cost of compensating injured workers. Since there are legal requirements regarding the documentation of these cases, it is relatively easy to identify at least a significant portion of the case costs.

Research conducted by the Liberty Mutual Research Center has identified the average and median cost for two categories of cases commonly associated with ergonomic risk factors, upper extremity cumulative trauma disorders (UECTDs) and low back cases. UECTD² and low back cases³ were found to average \$8,070 and \$6,807, respectively. Because the costs are skewed to the high side, the median costs are much lower, \$824 for UECTD and \$391 for low back cases.

Case cost information of this sort, paired with information regarding the number of cases occurring in the corporation, offers a good first approximation of the cost of ergonomic cases to the corporation. This might be used to develop justification for funding of pilot projects to demonstrate the effectiveness of ergonomic analysis and modification of high-risk jobs.

7.5 Cost Justification Methods

There are a number of ways to justify ergonomic spending. Some of these methods are discussed below.

Benefit/Cost Ratio

This simple method calculates the ratio between the benefits of an ergonomic project and the cost to implement it. The idea is that an ergonomics program that pays for itself is a good investment.

How do you calculate the economic benefit of an ergonomic solution? One way of calculating the economic benefit of an ergonomic program is to look at the cost of injuries associated with ergonomic problems. You make the assumption that implementing the ergonomic program will generate solutions which will prevent future injury. The calculation of the benefits to the cost ratio is shown below:

$$\text{Benefit to cost ratio} = \frac{\text{Value of benefits}}{\text{Cost of changes}}$$

Example:

An ergonomic injury has occurred once a year on average for a particular material handling job. The injuries have occurred when employees move bundles to and from sewing machine workstations. There are four material handlers in the area, and one injury has occurred in each of the last three years. The average cost of the injuries is \$20,000.

The cost of the solution is \$5,000. This money will purchase material handling equipment, raise platforms beside the sewing machines, and large work tables to store materials near waist height before they are distributed to the sewing operators.

$$\text{Benefit to cost ratio: } \frac{\$20,000}{\$5,000} = 4.0$$

In other words, the benefits of the ergonomics project are worth four times its cost. This is a sound investment.

Payback Period

You can also look at the payback period for an ergonomic improvement. Payback period refers to the length of time it will take to recover the costs of improvements.

First you must determine the costs and benefits associated with the ergonomics improvement. Then you can calculate the time it will take to offset the cost to implement. To calculate the payback period, use the following equation:

$$\text{Payback period (in years)} = \frac{\text{Costs per year}}{\text{Benefits per year}}$$

Example:

In the previous example, the costs of the injuries that the solution will prevent average \$20,000. The improvements cost \$5,000. How long does it take to recover the cost of the ergonomics solution?

$$\text{Payback period in years} = \frac{\text{Costs per yr.} = \$5,000}{\text{Benefits per yr.} = \$20,000} = 0.25 \text{ years (3 months)}$$

Another straightforward way of evaluating the benefit of an ergonomics program is to use return-on-investment analysis. Its calculation is shown below:

$$\text{Return on investment} = \frac{\text{Return to company}}{\text{Investment}} \times 100\%$$

Example:

$$\text{Return on investment} = \frac{\$20,000}{\$5,000} \times 100\% \text{ for a ROI of } 400\%$$

Using the data from the cost-to-benefit example, the return is the benefit, or \$20,000 for the avoided injury. The investment is the cost of the ergonomics solution or \$5,000 for the material handling changes. The return on investment is 400%.

As was shown earlier, this is a sound investment.

Losses vs. Goods Sold

You can also evaluate an ergonomic solution by determining the sales volume required to offset an injury. While the calculations for this method of analysis are relatively easy, you must know the profit margin for the business. The calculation is shown below:

$$\text{Volume of sales required to offset loss} = \frac{\text{Cost of losses}}{\text{Profit margin}}$$

Once the sales volume needed to offset the cost of the ergonomic injuries is determined, then the same effort used to generate this sales volume should be used to correct the ergonomics program.

Example:

A carpal tunnel surgery case has cost your company \$18,000 for medical and workers' compensation costs. The profit margin for your company has been 5% for the past three years.

$$\text{Volume of sales to offset loss} = \frac{\text{Cost of losses}}{\text{Profit margin}} = \frac{\$18,000}{.05} = \$360,000$$

This tells us that the effort to prevent an ergonomic injury for this company should be equivalent to the effort used to generate \$360,000 in sales.

Present Value (Time Value of Money)

You can enhance the previous cost justification techniques by including the time value of money in your calculations. With the technique, both the value of the savings and the value of the costs are reviewed over the economic life of the project, which may encompass several years. The technique takes interest effects into account. A dollar benefit realized at a future date is equivalent to a smaller amount of money invested now at interest. This equivalent value now of a future benefit is commonly known as the present value of a future benefit. This provides a common reference point to compare both the future benefits and the present costs.

The time value of money assumes that the value of a dollar today will be different a few years from now. For example, \$100 today, when invested at an interest rate of 8% per year, will have a value of \$108 in one year. This calculation is known as the *future value of present sum*. This is sometimes abbreviated as F/P.

Likewise, \$100 one year from now is only worth \$92.59 invested at 8% interest per year today. This calculation is known as the *present value of a future sum* (abbreviated as P/F). As you may suspect, they have a reciprocal relationship. The present value of a future sum may be used to express varying future benefits in terms of a present sum. This might be encountered when some years will produce more savings than others.

Often there will be a series of equal benefits over a number of equivalent periods which comprise the economic life of the project. Because these time periods are often, although not necessarily, years, the benefits are described as annuities. In the case of equivalent benefits occurring at equal time periods, two calculations are of use, the *present value of an annuity* (abbreviated P/A) and the *future value of an annuity* (abbreviated F/A).

The tables for determining the time value of money can be found in computer spreadsheet programs or in financial or engineering economy books. In order to select the appropriate table, you must know both the interest rate and the economic life of the project. Most companies have an interest rate that is used to evaluate projects in this manner. The tables list multipliers for the appropriate combination of interest rate and year. The cost or benefit is multiplied by the multiplier value given in the table in order to determine the present value.

Once the present values are determined, then the benefit to cost ratio or the return on investment calculation can be made.

Example:

A certain family of jobs has a recurring injury pattern. This is a sewing job, and there are 40 workers on the day and evening shifts. Approximately three lost time injuries have occurred each year. The injuries have required medical treatment and have sometimes resulted in lost workdays. The average cost of the lost time and medical treatment is \$1,000 per injury or \$3,000 per year.

Minor changes are needed to correct the ergonomics problem. The sewing machine head will be modified with a different guide, and the bundle table will be altered to make room for more asiding. These changes will cost \$500 per sewing machine workstation. The cost of the changes is \$500 per workstation times 20 workstations, for a total cost of \$10,000. This cost will be incurred immediately, so the present value of the cost is also \$10,000.

The value of the benefits is an annual savings of \$3,000. Based on outstanding contracts, there is reason to expect that the benefits will continue to accrue for a period of at least five years. Using a computer spreadsheet, we find the appropriate multiplier for an annuity at 8% annual interest for 5 years is approximately 3.993. We multiply this times the average savings of \$3,000 per year to obtain the present value of the savings over the five-year economic life of the project and find that it is \$11,979.

Determining the benefits to cost ratio is now simple:

$$\text{Benefit to cost ratio} = \frac{\text{Benefits}}{\text{Costs}} = \frac{\$11,979}{\$10,000} = 1.2$$

This is a sound investment as the benefits exceed the costs by 20%.

The return on investment can also be calculated using the present values of the benefits and costs. The calculations are shown below:

$$\frac{\text{Return on investment} = \$11,979 \times 100\% = 120\%}{\$10,000}$$

assuming that a family of jobs has experienced only one injury recently and that methods training has been suggested to avoid a similar injury in the future. The injury was a carpal tunnel surgery, and it was a serious compensation claim. The full cost of the injury was \$20,000. It is estimated that another injury would occur approximately every five years.

The methods training that has been recommended is relatively short and will only require each worker to spend one hour per year for the training. Since the training is done on the job, a trainer will also be required for each hour of training. The full cost of the training then will be 40 hours total for the 40 workers plus an additional 40 hours for a trainer. The average cost of a worker's time is \$6.50; and there is an additional cost for employee benefits of 25%. The cost of the trainer is \$8.00 per hour plus the employee benefit cost of 25%.

The annual cost of the training is:

Item	Costs
Workers: 40 workers \times 1 h./worker \times \$6.50/hour \times 1.25	\$325.00
Trainer: 40 hours \times 8.00/hr. \times 1.25	\$400.00
Annual Training Costs	\$725.00

The present value of the recurring costs for 5 years at 8% interest is the same as that calculated above. For a five-year period, it is 3.993 times the annual cost for a total of $\$725 \times 3.993 = \$2,894.93$.

$$F/A (8\%, 5 \text{ years}) \$725.00 = 3.993 \times \$725.00 = \$2,894.93$$

We assume, for simplicity, that the future benefit of avoiding a carpal tunnel case is a sum that will be realized five years from now. Looking in our reference, we find that the appropriate multiplier for the present value of a future sum (P/F) at 8% interest for five years is 0.6805. Multiplying the future value of \$20,000 by 0.6805 we obtain the present value of the benefit.

$$P/F (8\%, 5 \text{ years}) \$20,000 = 0.6805 \times \$20,000 = \$13,611$$

The cost to benefit ratio is:

$$\frac{\text{Cost to benefit ratio} = \$2,895 = 4.7}{\$13,611}$$

This is a sound investment.

7.6 How Do You Determine the Full Cost of an Injury?

A common problem in the justification of ergonomic improvements is that the benefits appear not to offset the costs. Typically, this is because the full dollar amount of the benefits has not been determined. You must capture all of the costs associated with the ergonomic injury. Some of the additional costs that are often omitted include cost of replacement workers, lowered productivity, lowered quality, and increased supervisory costs.

Cost of Replacement Workers

If a worker is injured and unable to work, then someone has to assume his/her function. This may be covered by offering overtime to other employees or by hiring more workers, perhaps on a temporary basis. In either case, there are extra costs involved which are directly linked with the injury case. Because the injured worker receives compensation to make up his/her lost wage, an employer in effect pays double for an off-the-job worker.

Lowered Productivity and Quality

Productivity may also be affected by an ergonomic case. If the worker is not replaced, fewer products are made; yet the overhead cost remains the same. This overhead may consist of the cost of production equipment, supplies purchased and on hand, heat and light, etc., as well as continuing employee benefits. The result is less product available for sale to defray overhead costs.

It is very likely that the worker covering for the injured individual is less familiar with the job and is more likely to make mistakes. This increased likelihood of error has associated costs. At best, it will result in an increase in the amount of rework or salvage operations necessary in order to produce a salable product. The extra labor and material cost of the rework are a result of the ergonomic injury. At worst, the defective product is beyond salvage. All the value of the previous work done to the product to convert it from raw material to goods in process is then a lost cost attributable to the ergonomic injury.

Increased Supervisory Requirements

A worker unfamiliar with a job will require more supervision or assistance from co-workers in order to perform a job. This may be as simple as not knowing where tools are stored or general unfamiliarity with the production process which leads to more required support time.

In addition, there are supervisory costs associated with the time required in preparing the paperwork necessary to process an injury case such as injury and illness reports, developing staffing schedules to cover for injured workers, etc.

Training

A worker unfamiliar with a job will need to be trained in how to perform it. During this time his production may be lowered, or nonexistent. There is also a cost associated with the time of the person who conducts the training.

Example:

An injury requires employees to work overtime to meet product demands. The ergonomic injury was not a major one, but it did result in lost time for six workdays. What are the costs in addition to the medical costs and lost time costs for the injured worker?

Employees earn an extra 50% for overtime pay. Since the replacement worker is from another department, he/she produces up to 12 fewer units per day for the six-day period. In addition, there were some quality problems—one reject at a cost of \$36 and five pieces which required rework at a cost of \$10 each. A summary of the costs is shown below:

Item	Costs
Overtime ($0.5 \times \$8.00/\text{hr.}$ for 6 days)	\$192.00
Lower productivity ($12 \text{ units/day} \times \4.00 profit/unit for 6 days)	\$288.00
Quality (1 reject)	\$36.00
Rework (5 units at \$10 each)	\$50.00
Total Additional Costs	\$566.00

Example:

An assembly task requires a worker to mount a component to a chassis with a single screw using a power driver. The two workers assigned to this area report two issues which have made this assembly operation a problem.

First, the screws frequently stop turning before being fully seated in the chassis. Because the screws are difficult to drive, operators have adjusted the clutches on their power drivers to the maximum torque limit. The power screw driver “kicks” or exerts a powerful torque on operators’ arms when the screw stops turning. This has caused some discomfort and minor injuries, but no lost time. To correct this, the operator reverses the screw out, then redrives it. This happens on every other unit. The second concern is that when the screw stops turning, the power driver often jumps out of the drive slots on the screw head. This happens about once for every five units. Occasionally, it strips out the screw hole in the chassis. This happens about once every 20 units. The standard rate is to expect the worker to finish three complete assemblies each hour during a ten-hour shift. Production is expected to continue indefinitely.

The first case requires the removal of the damaged screw and replacement. The second event requires the operator to re-drill the hole and replace the screw with an oversized one. Customers complain of “rattling” noises during operation if the assembly is not fastened correctly.

It takes approximately 30 seconds to successfully drive a screw, five minutes to remove a damaged screw, and one-half minute to re-drive a new screw. Redrilling the screw hole takes an additional five minutes.

Examination of the screws used reveals that they are not self-threading as the specification calls for. Utilization of the appropriate type of screw takes approximately 20 seconds, 10 seconds less than previously. The problems of improper seating, head stripping, and hole stripping are resolved by utilization of the appropriate screw. Adjusting the clutches on the power drivers eliminates the kickback torque to the workers’ arms. A summary of the costs and benefits is shown below.

Item	Cost
1000 screws discarded	\$18.51
1000 screw purchase	\$18.51
Total Costs	\$37.02

Item	Rework time per day	Cost Savings
Remove and replace		
(30 units/day × 0.2 units reworked × 0.092 h × \$10.00 h	=	\$5.50/day)
Redrill		
(30 units/day × 0.05 units reworked × 0.092 h × \$10.00 h	=	\$1.38/day)
Time saving per day		
Improved drill time		
(30 units/day × 0.0027 h saving × \$10.00 h	=	\$0.83/day)
Production time gained		
(30 units day × 0.25 units × 0.092 h × \$10.00 h	=	\$6.88/day)
Total Cost Savings	\$14.59/day per worker × 2 workers	= \$29.18 day

In these examples, by carefully measuring overtime, productivity, and quality, you can capture additional costs, even in the absence of an injury. This means that additional funds are available to offset the injury, regardless of the cost justification technique used.

7.7 How Do You Predict Future Injuries?

One of the most common questions asked during the cost justification of ergonomic changes is, "How do you know that another injury will occur?" One way is to simply see if injuries are, in fact, occurring annually. If they are, then demonstrating this pattern may be the most convincing method.

If the following is the recent pattern of compensable injuries, then you will likely see another injury unless the process is changed.

Year	1992	1993	1994	1995	1996
Compensable injuries	1	2	1	1	1

Often the trend is not as obvious, and predicting future injuries becomes more difficult. To respond to this, one can look at the pattern of less serious injuries, such as first aid visits; if that is stable, then the overall injury pattern is probably stable, as well.

In the data below, the pattern of compensable injuries appears to be inconsistent; the pattern of first aid visits and OSHA 200 log entries, however, is very consistent. Using the stability of these injuries permits a prediction of the more serious injuries.

Year	1992	1993	1994	1995	1996
Compensable injuries	1	0		0	1
OSHA 200 Log entries	4	5	4	3	5
First Aid Visits (nonrecordable)	9	10	10	8	10

In general, there is a consistent trend in less severe injuries, with OSHA 200 log entries occurring at a rate of roughly 4 to 5 per year, and nonrecordable first aid visits occurring at a rate of roughly 9 to 10 visits per year. This clarifies the injury pattern, which is not evident by simply maintaining a count of the compensable injuries. It also provides an excellent illustration of the ratio of minor to major injuries.

In this case, there are approximately three compensable injuries for every 21 OSHA 200 log entries and for every 47 first aid visits. Since both OSHA 200 log entries and nonrecordable first aid visits are relatively stable, we would expect a recurring compensable injury once every two years.

7.8 What Other Costs Should You Consider?

To justify ergonomics changes, look for productivity benefits which may occur. Many ergonomic changes will increase output, lower cycle time, and improve quality. For example, the use of guides and fixtures can control the pinch forces and hand/finger movements of sewing machine operators. Fixtures can also reduce the time to position and guide a product through the sewing head, improving the quality of the finished product. More comfortable seating can increase the amount of time spent in the sewing workstation, and this can be measured in daily output. Also, modifying inspection to improve the employee's comfort and lower the risk of injury can enhance inspection quality, resulting in fewer customer complaints.

Turnover can be a major cost, and is often overlooked. Turnover cost can be measured, and it is frequently a major cost. To determine the cost of the turnover, look at hiring costs, training costs, costs of rejects and lower output, and the opportunity cost of lost profits for products that are not shipped.

Example:

An ergonomic review was done on a key sewing job, and the costs of retrofit improvements were about \$50,000 for 50 workstations. The changes recommended included:

- Enhance the layout
- Position the person appropriately in front of the machine
- Modify lifting aids for large bundles
- Ensure appropriate material flow
- Alter the sewing machine orientation
- Tilt the sewing machine surface to better accommodate vision and reach
- Improve the quality of seating

Initially, it did not appear that costs associated with injury reductions, productivity improvements, or quality enhancements would be great enough to justify the ergonomic improvements. However, turnover was high on this job.

A task called final sewing was a key operation for this job. It required great skill and was a bottleneck for product output. Workers are sensitive to their working conditions: Since there are a number of apparel manufacturers in the area it is easy for people to shift to jobs where conditions are better. Final sewing for this employer is a high turnover job. While there are approximately 80 people on two shifts assigned to this job, turnover occurs at a rate of 10 to 20 people per year.

The training time to become fully proficient is approximately one full year. The worker is paid a training rate until incentive pay can be achieved. Also, because of the high skills required, substantial trainer time is needed to aid in skill development. Finally, many products are rejected or sent back for rework during the initial training period. Later in the training year, the major cost becomes the lost sales due to lower output from the new workers. The approximate costs to develop an experienced sewing machine operator who can perform the final sewing operation for this job are shown below:

Item	Costs
Training pay (wages not offset by production prior to full rate production)	1,500.00
Training time (80 h at 6.00/hr)	480.00
Trainer time (training and auditing time is 210 hr/trainee at \$9.00/hr)	1,080.00
Lower productivity	10,000.00
Rejects and rework	3,000.00
Lost profit	2,500.00
Turnover Costs	\$18,650.00

At an annual turnover rate of 10 to 20 workers per year, the full cost of the turnover is \$185,600 to \$371,200 per year. Reduction of turnover by only three individuals per year would pay back the cost of the modifications to the workstations.

7.9 Conclusions

There are a number of ways to justify expenditures for ergonomics improvements. Many methods are straightforward and simple to use as the preceding examples have shown.

When justifying ergonomic improvement, remember to:

- Make sure all the benefits are identified and fully measured.
- Determine the value of recurring injury costs. Do not short change yourself by counting only the first year.
- Implement the lowest cost solution which corrects the ergonomic problems, though it may not be the most sophisticated or elegant solution.
- Avoid high cost solutions such as automation.
- Ask if another plant has already solved the problem. Reinventing the solution is expensive and time consuming.

- Share information with other plants about the problems you have solved.
- Use cost measurements and justification on every project. The information will be valuable in justifying other ergonomics projects and in justifying your ergonomics program.

References

1. *Business Law: Text and Cases*, Howell, Allison, and Prentice. The Dryden Press, Hinsdale, IL, 1988, pp. 870-879.
2. The cost of compensable upper extremity cumulative trauma disorders, Webster B.S. and Snook S.H., *Journal of Occupational Medicine*, 36, 1994, pp. 713-717.
3. The cost of compensable low back pain, Webster B.S. and Snook S.H., *Journal of Occupational Medicine*, 32, 1990, pp. 13-15.

8

Economic Aiding and Economic–Ergonomic Interactions in Design and Management

8.1	Introduction	8-1
8.2	Economic Analysis Begins with the Identification of Costs, Benefits, and Required Investments.....	8-2
8.3	Interest Calculations and Discounted Cash Flows	8-3
8.4	Present Worth of Cash Flow Series and Functions	8-5
	Discrete Serial Models for Discounted Cash Flows • Continuous Models of Discounted Cash Flow • Estimating Parameter r in Serial and Continuous Models • Delayed Cash Flow Streams • Repeated Cash Flows Over Time	
8.5	Time Savings of Human Operators.....	8-11
	Some Alternative Forms of Analysis with This Example	
8.6	Economics of Learning, Forgetting, and Training.....	8-13
	Produce Lots as Needed • Make the Entire Year's Production at One Time • Alternative Strategies between These Extremes • Evaluating Training Programs	
8.7	Effects of the Lack of Manufacturing Specification on Repair	8-23
8.8	Parallel Processing Economics	8-24
8.9	Using Economic Principles to Guide Ergonomic Studies of Automated Highway Design.....	8-26
8.10	Personnel Selection Economics.....	8-29
8.11	Final Remarks.....	8-31

James R. Buck
The University of Iowa

8.1 Introduction

Studies of Economics preceded Ergonomics by a couple of centuries. That fact is one of the reasons that some economic notions are better understood than those in ergonomics. It also shows that the general public and management are influenced far more by economics. As a result, ergonomists must be prepared to meet the tests of economics if ergonomic recommendations are to find funding. As Rose et al. (1992) stated, “To succeed in introducing a new, ergonomically better working method, that method must also have economic advantages.” Accordingly, part of this chapter addresses the question of how ergonomic

proposals can be analyzed economically so that ergonomists can gain management's attention by showing appropriate economic evidence. Part of the analysis lies in estimating costs and benefits due to ergonomic interventions. Some new and improved methods of economic analysis are shown below that help in the estimation of appropriate costs and benefits as well as their analysis.

Numerous economic principles are very useful in ergonomic design, problem solving, and management. Some such principles are particularly useful during the establishment of a new ergonomics program in a company, while others tend to find greater merit later in the life of such programs. Numerous other interactions between ergonomics and economics are discussed in this chapter as well. In fact, some theories in ergonomics and engineering psychology stem directly from economics. For example, the ergonomic notion of human resource expenditures assumes that people behave as if they were expending their internal resources in an economic manner. Another example of the interrelationship between economics and ergonomics is the notion of concurrent tasking (i.e., attending to two tasks during the same time frame such as driving and talking). The Navon–Gopher model was heavily influenced by economic theory.¹ The following discussion explores these and other such interrelationships between economics and ergonomics.

8.2 Economic Analysis Begins with the Identification of Costs, Benefits, and Required Investments

Once an ergonomic project proposal is begun, one must start to mentally track the costs and gains for the proposal. There are a number of typical cost and benefit categories. A common example is labor savings as a result of new tools, a machine, or a new procedure of operation. The investment is the amount of money the company must pay for the tools, machine, or other facilities which generally last over a year. Items that the company buys that last less than a year are usually classified as expenditures, rather than investments, and are treated differently because of taxation laws and because short-term purchase prices are usually much less. Some companies, however, treat all expenditures as investments and require a more formal quantitative analysis. Accordingly, the following discussion makes no distinction between short-term and long-term projects.

At the outset of a project, one must identify each individual benefit and cost, estimate the cash magnitudes and occurrence times. For example, suppose an assembly operation is using a manually operated screwdriver to insert 6 screws in each assembly of a particular job. The total assembly takes 6 minutes for the entire assembly using the manual screwdriver. An ergonomist proposes substituting a power screwdriver for the manual one, a change that affects only the installation of the screws. The ergonomist measures the time the operator spends putting in the 6 screws manually, including the time it takes to pick up the tool and lay it back down. Suppose that the time required for this manual operation is about 5 seconds per screw for a total of 30 seconds plus about 10 seconds for pickup and drop off of the screwdriver. Then the ergonomist tries a power screwdriver and finds that it takes only 4 seconds per screw with the power screwdriver and the pickup and drop-off time was about the same. The apparent savings derived from the power tool is only 6 seconds per assembly, but that measurement fails to consider the fatigue effect of manual screwdrivers. The inclusion of this cost reveals that the power tool yields an average saving in direct time assembly of 3 seconds per screw or 18 seconds per assembly. Since the screw insertions are only part of the total assembly time of 6 minutes per assembly, the total time benefit per assembly is 0.3 minutes, and at \$12.00 per hour, the savings appear to be only \$0.06 per assembly. This calculation is not quite accurate, however, because it fails to consider the assembly in the context of the typical workshift. If the expected working time per shift is 408 minutes (480 minutes per shift excluding 15% for allowances), the production rate of a manual process is 408 min./6.0 min. per assembly or 68 assemblies per shift. With the new power screwdriver, the rate would be 408 min./(6.0 – 0.3 min.) or

¹See Wickens (1992) or Navon and Gopher (1979) for the concurrent tasking model and the resulting effect on performance.

71.58 assemblies per shift. This calculation shows that 3.58 more assemblies would occur during the shift if power tools are used. Now by examining the production run size of 10,000 assemblies, it is clear that the manual method would take 147.06 shifts @ 68 assemblies per shift but with the power screwdriver, it would only take 139.70 shifts. The savings over the production run are as follows:

$$147.06 \text{ shifts} \times 8 \text{ hours/shift} \times \$12.00/\text{hr} = \$14,117.65$$

$$139.70 \text{ shifts} \times 8 \text{ hours/shift} \times \$12.00/\text{hr} = \$13,411.57$$

According to these calculations, the total cost savings during the production run is \$706.08, not counting costs. An often overlooked point is that direct labor cost savings can occur only about 85% of the working time because of delay, fatigue, and personal allowances. That benefit stream would appear as a uniform cash flow totaling \$706.08:

$$139.70 \text{ shifts} \times 8 \text{ hours/shift} / 2000 \text{ hours/year} = 0.5588 \text{ years}$$

or \$706.08/0.5588 years or \$1,263.56 per year (but lasting a bit over half a year). It is assumed here that there is a single shift operation for this assembly over the year.

There is a required investment of about \$150.00 for a heavy-duty industrial-grade power screwdriver occurring at the beginning of the project, and the cost of the electricity over the life of the project must also be calculated. And finally, the expected life of the screwdriver is several years at the anticipated usage level. Using a \$0.05 per minute cost for power, the total cost over the production run is:

$$\frac{24 \text{ sec}}{\text{assembly}} \times \frac{71.58 \text{ assemblies}}{\text{shift}} \times \frac{139.7 \text{ shifts}}{\text{run}} \times \frac{1 \text{ min.}}{60 \text{ sec.}} \times \frac{\$0.05}{\text{min.}} = \frac{\$199.99}{\text{run}}$$

This calculation yields \$357.90 per year uniform cash flow over the 0.5588 years. Overlooking the time differences between these different cash flows and tallying them algebraically with outflows represented as negative outflows and inflows represented as positive, the net worth of this project based on one assembly station is as follows:

$$-\$150.00 \text{ investment} + \$705.23 \text{ benefits} - \$199.99 \text{ power} = +\$355.24$$

Most companies would be convinced at this point that the proposed project was economically sound, providing the estimates are accurate. However, as the following discussion reveals, the calculations are flawed in a number of ways.

8.3 Interest Calculations and Discounted Cash Flows

When an amount of capital is invested for a specified period of time, it normally earns interest. Traditionally, interest earned over a one-year time interval is indicated as $i\%$; this is known as the *nominal* interest rate. The simplest interest calculations assume a single compound interest period each year. An investment of P principal earns interest at the end of the year as Pi , and so the value of the account after one year is $P(1+i)$, often noted as F_1 denoting a future cash amount in 1 year. Both P and F are quantities of monetary value (e.g., dollars). When F_k is a future sum of money k years later and $k > 1$, then F_k is even larger than F_1 because of the longer interest-earning time. The relationship between P and F_1 or F_k turns out to be as follows:

$$F_1 = P(1+i) \quad \text{or} \quad F_k = P(1+i)^k \quad (1)$$

When interest is compounded k times each year, the relationship between F and P is calculated with the following equation:

$$F = P \left[1 + \frac{i}{k} \right]^k \tag{2}$$

According to Equation (2), when compounding is semiannual, k is two and F after one year is $(1 + i/2)^2 P$. Note that the bracketed part of Equation (2) is greater than the $(1 + i)$ value shown in Equation (1) for any value of $i > 0$. In fact, as k gets larger and larger, F increases but with a decreasing rate. For example, if the nominal rate i is 12% and P is \$1, then:

time period =	annual	semiannual	quarterly	—	bimonthly	monthly
k =	1	2	3	4	6	12
F =	1.1200	1.1236	1.1249	1.1255	1.1262	1.1268

The *upper limit* of F is 1.1275, and that limit occurs when compounding is continuous; that is, compounding periods are instantaneous. Notice that the bracketed amount on the right-hand side of Equation (2) approaches $e^{0.12}$ or 1.1275 in this example as k approaches positive infinity. Clearly, then, more frequent compounding creates more interest, but an upper limit exists with continuous compounding.

It also follows that continuous compounding can occur over a year's time, which is equal to any discrete interest rate and compounding period. This notion of equivalency is becoming better known as laws require banks, credit card companies, and other financial institutions to show equivalent annual percentage rates. The method of calculating this equivalency can be demonstrated with the following example, where continuous interest at rate j yields exactly 12% over one year with a single compounding period as shown below:

$$e^j = (1 + i) = 1.12 \tag{3}$$

By taking the natural logarithm (Ln) of each side of Equation (3), it follows that:

$$j = \text{Ln} \left[\left(1 + \frac{i}{k} \right)^k \right] \tag{4}$$

When k is one, the *equivalent continuous interest rate* for 12% annually is 11.3333%. For the nominal rate of 12% and various values of k, equivalent continuous interest rates are:

k =	1	2	3	4	6	12
j % =	11.3333%	11.654%	11.7699%	11.823%	11.885%	11.934%

That observation can be verified by replacing j in Equation (4) with the tabled values above. It follows that equivalent continuous interest rates for nominal rates stated by banks are as follows:

Nominal Interest Rate	6.0%	8.0%	10.0%	12.0%	14.0%	16.0%	18.0%	20.0%
Equivalent Continuous Interest Rate j =	5.83%	7.70%	9.53%	11.3%	13.1%	14.8%	16.6%	18.2%

Although one does not often think of continuous compounding, as opposed to annual, semiannual, or quarterly periodic compounding, the option to use it for computational convenience does not affect the computed interest when one uses an equivalent continuous interest rate. Also daily or weekly interest periods advertised by some banks are vastly closer to continuous interest than annual interest rates which many engineering economic textbooks allude to as the norm. Also, when interest is compounded periodically, none of the cash flows within a compounding period should have interest accredited until the very end of the time period. That is, if compounding is annual, events which occur during the year are

treated as if they occurred only at the end of the year. Banks maintain savings accounts for people with the promise that they will periodically find the amount of money in the account and credit the account with interest earned over that time period. The account holder controls the cash flow process by putting money into the account and taking it out, but interest earning is a separate process controlled by the bank. Theoretically, monies deposited into the account or taken out during the same interest-generating time period merely accumulate algebraically (inflows add and outflows subtract). However, this calculation does not hold when the money flows in during one interest-earning time period and out during another. Hence, dollars are said to have *time value*. Because of the time value of money, dollars at one point in time cannot be simply added or subtracted to dollars at another point in time. The principal implications here are that dollar values at an equivalent point in time can be added or subtracted and that cash flows at other points in time can be converted to equivalence through Equation (1) for 1 or k years and then added or subtracted. Without the conversion to equivalent values, cash flow cannot be added or subtracted.

8.4 Present Worth of Cash Flow Series and Functions

Present worth is a monetary value that occurs at the beginning of a project or a value that is equivalent to the algebraic sum of all the cash flows (inflows are + and outflows are –) in a project including accrued interest. Since invested capital earns money at the rate of i or an equivalent j percent or more, a cash flow of F_k dollars after k time periods have elapsed will have a present value that is calculated as follows:

$$P = F_k e^{-jk} = F_k (1 + i)^{-k} \quad (5)$$

It may also explain that when i or j is the *minimally acceptable (or attractive) rate of return* (MARR), the resulting present value is the least current value acceptable for any future value. Thus, if all future values were rescaled at equivalent current value by multiplying the actual cash flow that occurs at k by the factor e^{-jk} or $(1 + i)^{-k}$, the *algebraic* sum of these equivalent current values represents the total present worth. The typical convention is to sign all outflows as negative and inflows as positive. Projects with greater positive present worth are more preferred than those with smaller positive present worths, since all cash inflows add to wealth and all outflows detract from wealth, and the accumulation of present worth of inflows minus the worth of outflows represents the surplus current value. If the net present worth is zero, the investment is paid off exactly at the minimum attractive rate of return (MARR). The surplus in present worth tells one how much more the future returns on the investment accumulate beyond the minimum investment coverage.

Discrete Serial Models for Discounted Cash Flows

The future cash flows shown above consist of a single cash flow at the beginning of a project which is equivalent to several future cash flows. In most cases the equivalent present worth was found by finding the present worth equivalent to each separate future cash flow and then accumulating these equivalents algebraically using the sign convention of positive inflows and negative outflows. While that computational practice is correct, it is inefficient. An alternative procedure that is computationally efficient is the use of present worth factors for future time series. There are factors to several cash flow series which convert each member of the series into an equivalent present worth accumulation over the series. These factors provide computational convenience for analysts because the computation of a single formula handles the entire series rather than treating each member of the series individually.

These series also come with different functional forms over time, as shown in Table 8.1. The most elementary is the **step** function series which consists of a uniform series of C dollars at the end of each time period and going on for k serial flows. The present worth of the step series over k time periods is:

TABLE 8.1 Five Functional Series, Serial Magnitudes, Cumulative Quantities over k Periods, and Present Worths.

Functional Series	Magnitude at Time k	Cumulative Cash Flow from Time 0 to k	Present Worth at the Minimum Attractive Rate of Return i or P(i) =
STEP	f(k) = C typical of operating cost	$\sum_{x=1}^k f(x) = Ck$	$\frac{C}{i} [1 - (1+i)^{-k}]$
UP-RAMP	f(k) = Ck typical of maintenance and deterioration costs	$\sum_{x=1}^k f(x) = C \frac{k(k+1)}{2}$	$\frac{C}{i^2} [1 - (1+i)^{-k}] + \frac{C}{i} [1 - (k+1)(1+i)^{-k}]$
DOWN-RAMP	f(k) = R - Ck typical of lost sales due to fewer customers (R > Ck)	$\sum_{x=1}^k f(x) = Rk - \frac{Ck(k+1)}{2}$	$\frac{Ri - C}{i^2} [1 - (1+i)^{-k}] + \frac{C}{i} [1 - (k+1)(1+i)^{-k}]$
DECAY	f(k) = Ce ^{-rk} startup costs	$\sum_{x=1}^k f(x) = C e^{-r} \left[\frac{e^{-rk} - 1}{e^{-r} - 1} \right]$	$\frac{C}{1+i - e^{-r}} \left[e^{-r} - \frac{e^{-(k+1)r}}{(1+i)^k} \right]$
GROWTH	f(k) = R - Ce ^{-rk} maintenance costs of aging equipment	$Rk - C e^{-r} \left[\frac{e^{-rk} - 1}{e^{-r} - 1} \right]$	$\frac{R}{i} [1 - (1+i)^{-k}] - \frac{C}{1+i - e^{-r}} \left[e^{-r} - \frac{e^{-(k+1)r}}{(1+i)^k} \right]$

$$P(i) = C \sum_{k=1}^K (1+i)^{-k} = C \frac{1 - (1+i)^{-K}}{i}$$

where the final term in the equation above is the sum of the series (1+i)⁻¹+ (1+i)⁻²+...+ (1+i)^{-K}. Table 8.1 shows the step and four additional functional cash flow series where each successive time in the series is an interest compounding time in which cash flow events occur. The final column in Table 8.1 describes the present worth formula for the step and other series. Actual time series of values and typical kinds of cash flows where the series is often appropriate are shown in the second column. The fourth column in Table 8.1 is simply the cumulative sum of undiscounted cash flows. These cumulative sums are useful in estimating cash flow constants R and C in these series from accounting or other data sources.

In the case of a step series of \$100 each time period for 3 years, with a minimum attractive rate of return of 10%, the formula and computation of present worth is as follows:

$$P(i) = \frac{C}{i} [1 - (1+i)^{-k}] = \frac{\$100}{0.1} [1 - (1+0.1)^{-3}] = \$248.69$$

In effect, this is equivalent to 3 individual cash flows of \$100 each at the end of years 1, 2, and 3. Individual computations over the three cash flows are more cumbersome, as the following equation demonstrates:

$$P(0.1) = 100 (1.1)^{-1} + 100 (1.1)^{-2} + 100 (1.1)^{-3} = 90.91 + 82.64 + 75.13 = \$248.69$$

Obviously, the computational savings of a series improves with the length of the series, and that is one important advantage of series formulae.

While the process of cash flow generation is really a separate process from interest generation, calculations describing these processes in Table 8.1 are *not* totally separable. The reason is because the fundamental time period between successive time points in a series must correspond to the interest-generating process, as this

correspondence is the basis of compounding. When that fact is clear and unambiguous, there is no difficulty in using these serial descriptions of cash flow.

Other functional series are shown in Table 8.1 and some comments on them are appropriate. There are two varieties of **ramp** series. The first is the up-ramp, which starts flowing in the first time period at C and then continues at $2C$, $3C$, $4C$, ... dollars in time periods 2, 3, 4, and so forth, respectively. As Table 8.1 notes, up-ramp series are often used to describe increasing costs over time due to deterioration and required maintenance of equipment. Many textbooks on engineering economy or financial calculations² present a functional series known as a *gradient* that also increases uniformly the flow amount of money over time. However, there is no cash flow for the gradient at the first time period and the flows at time periods 2, 3, and 4, are respectively, C , $2C$, and $3C$ dollars. Accordingly, the up-ramp series differs from the gradient, although it bears similarities. The **down-ramp** series is nothing but a step function of R dollars per period minus an up-ramp of $\$C$, so long as $R_k > C_k$. A common example of a down-ramp series is reduced revenues expected as the result of deteriorating machinery or seasonal decreases in revenues from the sales of off-season products. Two other serial functions, the **decay** and **growth** series, are shown in Table 8.1. Startup or learning costs can often be captured by decay series, and maintenance costs frequently follow a growth series. Here again, present worth formulae are presented in Table 8.1 for these series as well.

In addition to the present worth formulae, Table 8.1 describes the magnitude of the series at specific points in time (in column 2) and the cumulative sums over time from $t = 1$ to $t = k$ (in column 3). As noted above, before the economics of the situation can be analyzed, the benefits and costs must be identified and estimated. These other formulae in Table 8.1 are useful in this estimation once the different benefit and cost streams are identified. In fact, part of the identification involves a recognition of the general nature of the costs and benefits over time. For example, a maintenance cost would be expected to increase more with time and so an up-ramp series or a growth series would be likely candidates for describing this situation. Then it is merely a case of finding which functional series best describes these costs. If past records indicate increasing values at a diminishing rate over time, the growth series would be a better choice than the up-ramp. By fitting the function $f(t)$ for the magnitude of that series to previously recorded data on costs, the following series of equations will result:

$$f(1t) = R - Ce^{-r} \text{ and } f(2t) = R - Ce^{-2r} \text{ and } f(3t) = R - Ce^{-3r}$$

The values of R , C , and r that best satisfy those estimates are the most reasonable values. More data facilitate a statistically better fit. Sometimes available data (e.g., accounting records) show cumulative expenditures, rather than serial expenditures. In such a case, the cumulative values can be used as follows:

$$\sum_{n=1}^K f(t) = R - Ce^{-r}, \quad \sum_{n=1}^2 f(t) = R2 - Ce^{-r} \left[\frac{e^{-2r} - 1}{e^{-r} - 1} \right], \quad \sum_{n=1}^3 f(t) = R3 - Ce^{-r} \left[\frac{e^{-3r} - 1}{e^{-r} - 1} \right]$$

Any combination of the series magnitudes and cumulative serial amounts can be used.

As stated above, the use of a series carries the assumption that the time period between successive cash flows is constant and can be designated as the interest-generating time period. If one chooses to use a quarterly time period, the interest rate charged per time period should be the nominal MARR divided by four. It also follows that the series magnitudes are the costs or benefits over that quarter-of-the-year time interval or whatever period the analyst chooses. Although interest and cash-flow generating processes are theoretically separate, the algebra describing a series makes it difficult to separate them. One could use monthly series with an interest rate per month as one-third of a quarterly interest rate. That computation would contain only a very slight error and one far less than the expected errors of estimation, but highly frequent series computations become cumbersome.

²See Au and Au (1992), Newnan (1996), Fabrycky, Thuesen, and Verma (1998).

Continuous Models of Discounted Cash Flow

An alternative to modeling cash flows as series is to model cash flows as continuous flow functions over time. For example, a continuous step function accumulates \$C over a year and the accumulation each month is 1/12th of C. One of the distinct differences between series modeling and continuous cash flow modeling is that series parameters correspond to the individual serial flows, but continuous model parameters pertain to the flow *over a year*. For example, a continuous up-ramp that has a parameter of \$C per year means that the flow magnitude each year increases the flow density by \$C more each year. At the beginning of the first year, the flow was \$0 per year and, by the end of the year, cash is flowing at \$C per year. During that first year, the accumulated cash flow is $(\$0 + \$C)/2$ or $\$C/2$ because the flow going from \$0 to \$C can be represented as a triangle with a base of 1 year and an area that contains $\$C/2$. That same up-ramp reaches a magnitude of \$2C over two years and the accumulation is $\$4 C/2$ or $\$2C$. It is often helpful to think of continuous cash flows over time as analogous to putting a pail below a water faucet. The magnitude of the cash flow rate at any point in time is analogous to the amount the faucet value is open, but the amount of flow into the pail depends upon how long the faucet is set at a given opening. Step flows describe the case in which the faucet is set at a constant opening over time. An up-ramp flow is analogous to putting the pail below the faucet and then uniformly increasing the faucet opening. The reverse is true for a down-ramp flow. When that down-ramp represents benefits, the stream of benefits gets thinner and thinner, supporting fewer and fewer business operations. Continuous cash flows accord with the notion of stream flow and this form of modeling has some mathematical and conceptual advantages. For one thing, a continuous flow can be stopped at any point without concern about the next serial value, and whether or not it should be included in the calculation. Continuous flows carry continuous compounding so that compounding time periods are not a problem; the continuous interest rate must be set to be equivalent with the nominal rate or with a natural monthly, quarterly, or semiannual rate as shown above. Moreover, some of the formulae for continuous cash flows are a bit simpler than the discrete series, yet they yield the advantage of describing flows over various time periods.

Table 8.2 shows formulae for computing the present worth of continuous cash flow functions that start immediately, accumulate up to time k , and then stop. In all of those formulae, it is assumed that both the pattern of changing cash flow and the start of cash flow occur at time zero relative to the project start. As with the Table 8.1 formulae, Table 8.2 shows cash flow densities at any future point in time as well as cumulative functions of cash flow. Those density magnitude and cumulative flow formulae are particularly useful in setting the C and r parameters in these continuous flow models.

Note that when k is a very long time, the value of e^{-jk} in the formula in Table 8.2 approaches zero. Similar to the series formulae, this situation greatly simplifies the formula in Table 8.2. In the case of a step function, the present worth calculated for a very long time period approaches C/j . With an up-ramp function, the present worth approaches C/j^2 .

The formulae for continuous cash flows in Table 8.2 correspond closely to those for discrete cash flow series in Table 8.1. For example, in the step function with a constant flow per year over k years at j percent interest, if j is set at 9.53%, the equivalent continuous interest rate for 10%, the present worth over three years, is calculated as follows:

$$P(j) = C \frac{1 - e^{-jk}}{j} = \$100/\text{year} \frac{1 - e^{-0.0953(3)}}{0.0953} = \$260.93$$

The reader may recall that a similar calculation using the Table 8.1 formula and 10% annual discrete interest yielded only \$248.69 rather than \$260.93. Since the exponential term in the fraction part of the equation above is equal to the numerator in the discrete series step function, the only cause of a difference is the j in the denominator, in contrast to the i in the denominator for a series step formula. In other words, $\$260.93 \times 0.0953/0.1$ is \$248.67. This example demonstrates that present worths of continuous flows and discrete serial flows are different, even when the interest rates are termed “equivalent.” The amount of this difference, however, is typically small.

TABLE 8.2 Five Continuous Functions of Cash Flow, Magnitudes at Specific Points in Time, Cumulative Quantities over k Time Periods, and Present Worths

Continuous Function	Magnitude at Time k	Cumulative Cash Flow from Time 0 to k	Present Worth at the Minimum Attractive Rate of Return j (Continuous Compounding) or P(j) =
STEP	$f(k) = C$ typical of operating cost	$R \int_0^k dx = R k$	$\frac{R}{j} [1 - e^{-jk}]$
UP-RAMP	$f(k) = C k$ typical of maintenance, and deterioration costs	$C \int_0^k x dx = C \frac{k^2}{2}$	$C \left(\frac{1 - e^{-jk}}{j^2} - \frac{ke^{-jk}}{j} \right)$
DOWN-RAMP	$f(k) = R - Ck$ typical of lost sales due to fewer customers (R > Ck)	$R \int_0^k dx - C \int_0^k x dx = \left(R - \frac{Ck}{2} \right) k$	step less up-ramp R > Ck
DECAY	$f(k) = Ce^{-rk}$ startup costs	$C \int_0^k e^{-rx} dx = C \left[\frac{1 - e^{-rk}}{r} \right]$	$\frac{C}{j+r} [1 - e^{-(j+r)k}]$
GROWTH	$f(k) = R - Ce^{-rk}$ maintenance costs of aging equipment	$C \int_0^k (1 - e^{-rx}) dx = C \left[\frac{rk - 1 + e^{-rk}}{r} \right]$	step less decay

Estimating Parameter r in Serial and Continuous Models

Sometimes analysts have difficulty estimating the exponential parameter r in decay and growth models. One aid to making these parameter estimates is to find the expected cumulative cash flows over one and two time periods. Theoretically, it does not make any difference what time period is selected, but in practice a period long enough to reveal changes in the flow is most desired. Thus, if the changes were relatively rapid, monthly time periods would be adequate. However, quarterly, semiannual, or annual periods are preferable for flows that change less frequently over time. Note in Tables 8.1 and 8.2 that the cumulative cash flow of a decay cash flow over k time periods is as follows:

$$S(k) = \frac{C}{-r} [e^{-kr} - 1]$$

Now consider the ratio S(1)/S(2) describing the occurrence of a two-period flow during the first period:

$$\frac{S(1)}{S(2)} = \frac{[e^{-r} - 1]}{[e^{-2r} - 1]} \tag{6}$$

In a similar fashion, the growth model has the following ratio:

$$\frac{S(1)}{S(2)} = \frac{e^r - 1}{e^{2r} - 1} \tag{7}$$

TABLE 8.3 Ratios of S(1)/S(2) for the Growth and Decay Continuous Cash Flow Functions Corresponding to Selected Values of Parameter r

parameter $r =$	0.01	0.03	0.05	0.07	0.09	0.10	0.20	0.30
growth S(1)/S(2) =	.2508	.2525	.2542	.2558	.2574	.2567	.2660	.2742
decay S(1)/S(2) =	.5050	.5086	.5026	.5176	.5228	.5251	.5499	.5745
parameter $r =$	0.40	0.50	0.60	0.70	0.80	0.90	1.00	1.10
growth S(1)/S(2) =	.2820	.2895	.2969	.3041	.3109	.3176	.3141	.3303
decay S(1)/S(2) =	.5987	.6225	.6456	.6682	.6900	.7109	.7310	.7502
parameter $r =$	1.20	1.30	1.40	1.50	1.60	1.70	1.80	1.90
growth S(1)/S(2) =	.3362	.3419	.3475	.3528	.3579	.3623	.3674	.3719
decay S(1)/S(2) =	.7685	.7859	.8022	.8176	.8320	.8455	.8581	.8699
parameter $r =$	2.00	2.10	2.20	2.30	2.40	2.50	2.60	2.70
growth S(1)/S(2) =	.3761	.3802	.3841	.3879	.3914	.3949	.3981	.4012
decay S(1)/S(2) =	.8808	.8909	.9003	.9089	.9168	.9241	.9309	.9370

It follows with the step function that the S(1)/S(2) ratio is 0.5, and with an up-ramp function, it is 0.25. A growth function with a very small r value increases in time almost uniformly, and so that ratio should be similar to the up-ramp when r is small. The r values of growth functions thus lie between 0.25 (with a small r) and 0.5 (with a large r). In a similar manner, decay functions with a small r behave similarly to step functions. Hence, the S(1)/S(2) ratios of decay functions vary from about 0.50 with a very small r and increase up to 1.00 as r increases. Table 8.3 verifies these observations by describing associated S(1)/S(2) ratios for growth and decay functions at various r values from 0.01 to 2.70.

Delayed Cash Flow Streams

All of the present worth functions in Tables 8.1 and 8.2 are assumed to start immediately and continue for k years. If the stated pattern of cash flow is delayed b time units before the pattern starts but the pattern is otherwise exactly the same *after starting* i , then the present worth without delay (P') can be computed exactly as if it had started immediately. To find the correct present worth for the pattern delay of b time units, the following formula may be used:

$$P = e^{-jb}P' \quad (8)$$

For instance, suppose that a 3-year-long step function of \$100 each year were to experience a 2-year delay but remain otherwise unchanged. The present worth could then be figured out as \$260.93, as shown earlier, and the delay of 2 years is computed as follows:

$$P = e^{-0.11333(2)} 260.93 = \$ 208.01$$

Note that once a cash flow pattern is recognized and fitted with parameter values to reflect actual cash flows, those patterns and parameters can be directly used along with the equivalent continuous interest rate to compute present worths. In this use, continuous interest rates are considered to be the minimum acceptable rate of return on company-invested capital.

Repeated Cash Flows Over Time

A typical situation in modeling the cash flows of a project finds that costs or returns associated with maintenance, production, and such other processes repeat themselves over time. Such situations are similar to that of a homeowner who must perform maintenance on the heating and air-conditioning system twice a year, year in and year out. In that situation the present worth of the first event in the

series can be multiplied by factors which change future cash flows at each future occurrence into equivalent present worth amounts as follows:

$$PW\left[1 + e^{-jk_1} + e^{-jk_2} + e^{-jk_3} + e^{-jk_4} + \dots + e^{-jk_{(n-1)}}\right]$$

This formula describes the n recurrences of that cash flow at future times 0, $k_1, k_2, k_3, \dots, k_{n-1}$; each member of the series is e^{-jk_1} times the previous serial value. Whenever there are very many of these future times, it is inconvenient to compute each of them individually and then sum up the bracketed expression. Since this expression is a geometric progression (series), the sum over the first n term is as follows:

$$PW\left[1 + \sum_{i=1}^{n-1} e^{-jk_i}\right] = PW\left[1 + e^{-jk_1} + \dots + e^{-jk_{(n-1)}}\right] = PW\left(\frac{1 - e^{-jn}}{1 - e^{-j}}\right) \tag{9}$$

Accordingly, it is useful to recognize repeated cash flow patterns over time and use the relationship above to simplify calculations.

8.5 Time Savings of Human Operators

A typical human operator in industry works a 480-minute shift each of 5 days per week for about 50 weeks per year. This working arrangement amounts to about 2000 paid hours per human operator per year. When the allowances total about 15%, the remaining 85% of effective work hours equals 1700 effective hours per year. If that operator is paid at a stated rate of \$ K per hour, the actual cost per hour over the year is:

$$K' = \frac{2000 \text{ h/yr}}{1700 \text{ h/yr}} \left[\$\frac{K}{\text{h}} + \frac{\text{Other Benefits}}{\text{yr}} \right]$$

Note that if other benefits per year are zero, the cost per actual worked hours (K') is about 1.1765 \$ K . Savings in performance time of a human operator can only be calculated on the actual time worked, not the total time.

The traditional manner for analyzing the economics of new tools and devices to aid production is to cost out the method with and without the new tool or device. The cost of the new tool or device is the principal P , which is subtracted from the present worth of cost difference or cost savings. For example, consider a particular item that requires 2 minutes/piece (0.0333 h per piece) when 100,000 pieces are made per year in a single production run. This product requires 3,333 active assembly hours, $3,333/0.85 = 3,921$ actual production hours; which requires $3,921/20,000$ per year or 0.19606 years. At a stated rate of \$12/h, the cost is \$47,052 over the course of the year. If the new tool or device saved 10% of the actual production time, the active time hours are 90% of the 3,333 h or 3,000.0 active hours, which amounts to $3000/0.85$ or 3,529 actual production hours (i.e., 0.17645 years). The cost of production with the tool or device over the course of the year is $12 \times 3,529$ h or \$42,353 per year, yielding a cost difference of \$4,699 on the investment principal of \$200 in less than a year. The economic advantage of this tool or device is so obvious that further analysis seems unnecessary. Yet some problems remain. One is that the actual time of production differs, so it is difficult to use discrete interest rates to evaluate present worth. Some analysts ignore time differences within a year and assume all within-year costs as occurring at the end of the year. These analyses might calculate the present worth of the savings at a 12% MARR as follows:

$$P = \$4,699 (1.12)^{-1} - \$200 = \$3,996$$

In other words, this investment repaid the principal and 12% interest on the principal, plus an additional \$3,996.

Some Alternative Forms of Analysis with This Example

An alternative but analogous form of analysis is to use continuously compounded interest at the equivalent MARR or 11.333% in this example. The present worth of existing operations without the tool or device can thus be computed as follows:

$$P = \$24,000 \frac{[1 - e^{-0.11333(0.19606)}]}{0.11333} = \$4,654.$$

With the tool or device, the present worth calculation is:

$$P = \$24,000 \frac{[1 - e^{-0.11333(0.17645)}]}{0.11333} + 200 = \$4,393.$$

The resulting difference of \$261 is the net present worth of savings over the principal. Although, this second form of analysis gives the same result, accounting for the actual time differences within the year shows that ignoring within-year time effects can sometimes mislead the decision maker.

An associated form of analysis is annual worth analysis. This annual worth amount can be computed directly from the present worth using the annual-worth-to-present-worth factor as follows:

$$P = C \frac{[1 - e^{-jk}]}{j} = C \frac{[1 - e^{-11333(1)}]}{0.11333} = 261.$$

The value of C that satisfies the above equation is the annual worth, or \$276. One could compute the equivalent annual worth without and with the tool or device as follows:

$$C_{w/o \text{ device}} \frac{[1 - e^{-11333(1)}]}{0.11333} = 4,654$$

$$C_{w \text{ device}} \frac{[1 - e^{-11333(1)}]}{0.11333} = 4,392$$

where the two respective C values are $C_{w/o \text{ device}} = \$4,922$ and $C_{w \text{ device}} = \$4,646$. The difference between these two annual worths is the net annual worth of the cost savings which is \$262 per year.

Another form of analysis which is quite popular but sometimes very misleading is the internal rate of return basis for comparing alternative projects. In such cases, the internal rate of return over an entire year is found by setting the present worth of the savings, without specifying the interest rate, against the investment principal. For the present example, the calculations could be:

$$200 (1 + i) = \$4,699 \quad \text{or} \quad i = 22.495$$

This result shows that this investment earned 2,250% of the supplied principal. Here again, this analysis ignores within-year time differences. While the internal-rate-of-return method of analysis has difficulties, it does point out those actions that should be avoided. If the internal rate of return falls below MARR, that action should *not* be undertaken. Also, with two alternative actions that essentially do the same thing but one costs more and provides a better return, one can test the more expensive alternative to see if the *added* return earns at least the MARR on the added investment. Only when it does can the more expensive alternative be considered economical.

8.6 Economics of Learning, Forgetting, and Training

One of the better known topics of ergonomics is learning. People perform tasks better with practice and the effect is known as *learning*. When practice on a task is stopped for a protracted time, performance on that task deteriorates, and the effect is known as *forgetting*. Accordingly, learning is performance improvement with practice, and forgetting is performance deterioration due to lack of practice. In industry, learning is described by shorter performance times or greater production rates as more and more production occurs. One model of learning³ is based on performance time on the n th sequential unit of production:

$$y_{n+1} = \alpha y_n + \beta \tag{10}$$

In Equation (10), α and β are constant parameters of the model. In effect, this model predicts performance on the next product unit as the current performance time multiplied by the constant α plus a constant β . Since learning is improvement, α is defined as a fraction ($0 < \alpha < 1$). The values of y_{n+1} decrease progressively with each new unit produced but at a decreasing rate which approaches the asymptote y^* :

$$y^* = \frac{\beta}{1 - \alpha} \tag{11}$$

The asymptote associated with this learning curve provides an advantage in using this model of learning over many others.⁴ A more effective prediction equation for this discrete model is as follows:

$$y_n = \alpha^n [y_1 - y^*] + y^* \tag{12}$$

Equation (12) describes the performance time on the n th production unit based on performance on the first production unit and the asymptote y^* . Another useful feature of this learning curve model is the differences between sequential performance times, calculated as follows:

$$\Delta y_n = y_{n+1} - y_n = \alpha y_n + \beta - y_n = (\alpha - 1) y_n + \beta \tag{13}$$

If performance times are generally decreasing, the average Δy_n is negative. Also, as Equation (13) denotes, Δy_n is a linear function of y_n . With a short sequence of performance times, then one can compute the forward differences Δy_n as a function of y_n . For instance, suppose that the following performance times were recorded on the first five production units:

	n				
	1	2	3	4	5
time (hours) = y_n	10.000	9.920	9.842	9.765	9.689
$\Delta y_n =$	-0.0800	-0.078	-0.077	-0.0755	—

³The discrete exponential model shown by Pegels (1969) and by Buck, Tanchoco, and Sweet (1976) is based on the first-order difference equation with constant coefficients which Goldberg (1961) describes in detail. Hutchings and Towill (1975) describe a similar but not identical model.

⁴The powerform learning curve, noted by Snoddy (1926) and later by Wright (1936), which is much better known in the U.S., does not have a natural asymptote and so an artificial asymptote at $n = 1000$ is often used. Hax and Majluf (1982) used this same model for describing improvements over time by whole industries.

TABLE 8.4 Some Basic Data on the Learning Curve in the Numerical Example

	n						
	10	20	30	40	50	60	70
Total Hours $Y_n =$	96.59	186.48	270.90	350.86	427.16	500.49	571.38
Trans. Hours	36.59	66.48	90.90	110.86	127.17	140.49	151.38
% Trans.	37.9	35.9	33.2	31.6	29.8	28.1	26.5

When Δy_n is plotted as a linear function of y_n , the following equation results:

$$\Delta y_n = 0.1055 - 0.01853 y_n$$

This result is obtained by using a simple linear regression routine on a calculator where the coefficient of determination is $r = 0.99$. Based on Equation (13), $\alpha = 0.98$ and $\beta = 0.12$. By substituting these values in Equation (11), one finds the asymptote y^* is 6.0 hours per unit and the production time on each production unit can be described with the following equation:

$$y_n = 0.98^n [10.00 - 6.00] + 6.00$$

With this discrete exponential model of learning, the total production time required to produce a total of n units is as follows:

$$Y_n = \frac{1 - \alpha^n}{1 - \alpha} [y_1 - y^*] + y^* n \quad (14)$$

In the example above, the total production time can be described with the following equation:

$$Y_n = \frac{1 - 0.98^n}{1 - 0.98} [10.0 - 6.0] + 6.0 n$$

In Equation (14) the last term on the right-hand side is the asymptotic values times the number of items produced. In essence, that value is the steady-state value and the first term in that equation shows the transition time required by the learning process. For the example above, the transition and total production hours for selected values of n are shown in Table 8.4. The last row of this table reports the transition production time (added time for learning) as a function of the total time. As the production run gets longer, a smaller and smaller fraction of production time is required for learning.

An economic question with production is the economic production run length. Stated otherwise, "How many items should the company make each time it starts up production of this item?" Typically, a company builds up a component that is used in several products over the course of a year. If it makes the entire yearly production in one single run, the company takes advantage of the learning process and minimizes the number of production setups needed per year. But with a single annual production run, many items must be placed in inventory until needed and the inventory costs are often substantial. Consider as an example the product unit made by the company which needs 80 lots per year uniformly over the year. This usage rate is about 1.6 units per week or 6.67 per month, averaging 0.04 per production hour. Now let us consider several production strategies in separate sections below.

Produce Lots as Needed

At one extreme, the company could make a unit of the product during the first 10 hours and then cease production. After every 15 production hours, the company could start producing another unit and then

after 10 production hours another lot is ready. In this case the learning is minimal and production is spread out to the maximum so that inventory is least. Crews who set up the production runs are repeating their jobs frequently. To put this situation into a specific numerical example, suppose that production work per operator cost \$12/hour. Over the course of a year (or 2000 production hours) the uniform annual cost is \$24,000. Building one lot at a time is expected to require 10 hours each time because there is no experience time for learning. Each production run of 10 hours has a present worth of:

$$PW(\text{production}) = \frac{\$24,000}{0.11333} \left(1 - e^{-0.11333 \frac{10}{2000}} \right) = \$119.97$$

if it started immediately. However, only the initial run of one lot starts immediately, the remaining 79 lots occur every 15 production hours. Accordingly, the total PW of production is:

$$\begin{aligned} \text{Total PW} &= \$119.97 \left[1 + e^{-0.11333 \frac{25}{2000}} + e^{-0.11333 \frac{50}{2000}} + \dots + e^{-0.11333 \frac{1975}{2000}} \right] \\ \text{Total PW} &= \$119.97 \left[\frac{e^{-0.11333 \frac{25}{2000} \cdot 80} - 1}{e^{-0.11333 \frac{25}{2000}} - 1} \right] = \$9,073.71 \end{aligned}$$

However, before each production run can occur, a setup crew comes in and gets everything ready. Setup costs are estimated at 15 operator hours times \$12/hr or \$180 each, and each is done off shift just prior to production. So the setup cost component present worth is:

$$\text{Total PW} = \$180.00 \left[\frac{e^{-0.11333 \frac{25}{2000} \cdot 80} - 1}{e^{-0.11333 \frac{25}{2000}} - 1} \right] = \$13,613.97$$

The only other cost component to be considered is the inventory cost (also known as storage or holding cost). In the particular case where only one lot is produced at a time and production is timed to finish just as the lot is issued, there are no inventory and zero inventory costs. The other two components sum to \$22,687.68 each year.

Make the Entire Year's Production at One Time

At the other extreme, the company could make the entire year's requirements in a single production run. If the learning curve continued as described, the required production time yielded by Equation (14) would be computed as follows:

$$Y_{80} = \frac{1 - 0.98^{80}}{1 - 0.98} [10.0 - 6.0] + 6.0(80) = 640.27 \text{ h}$$

For a company which works single shifts all year, this production strategy requires 16.65 weeks, 83.24 shifts, or 0.32 years. Actual production costs are \$12/hour or \$24,000 per year at a uniform rate so that present worth of the production operation is a step function of \$24,000/year over the 0.32 years as:

$$PW_{\text{production}} = \$24000 \left(\frac{1 - e^{-0.11333(0.32)}}{0.11333} \right) = \$7,542.41$$

During these 640.27 production hours, the company issues some components from production, and inventories the production surplus. The number of issues during production can be described as follows:

$$640.27 \text{ production hours} \times 0.04 \text{ lots per hour} = 25.6 \text{ lots}$$

If 80 lots are produced during production but during the same duration 25.6 are dispensed, the net inventory at the end of production is 54.4 lots. Inventory increases from the start of production. Although the rate of lot production is not constant, due to the learning curve, an average rate would be $80/640.27$ or about 0.125 per production hour. Lots are issued out of inventory at the rate of 0.04 per hour so that inventory builds during production at approximately 0.085 per hour. Accordingly, the inventory cost component during the production of 80 lots is approximated by a ramp which increases at the rate of 0.085 per production hour or 170 lots per year times \$1000 per lot per year. The present worth of this inventory buildup is:

$$PW_{\text{inv}} = \$170,000 \left[\left(\frac{1 - e^{-.11333(.32)}}{.11333^2} \right) - \left(\frac{0.32 e^{-.11333(.32)}}{.11333} \right) \right] = \$8,496.4$$

There is also the single setup cost of \$180 at time zero. The inventory cost from the end of production over the rest of the year decreases uniformly, and so the inventory cost can be described as a down-ramp (see Table 8.2). The step portion of this down-ramp has an initial inventory level of 54.4 lots at a \$1000 per year per lot is:

TABLE 8.5 The Effect of the Production Run Size on Cumulative Storage (Inventory) Requirements

	no. made at a time							
	10	20	30	40	50	60	70	80
Manuf. hours	96.59	186.48	270.90	350.86	427.16	500.49	571.38	640.27
Issued during manuf.	3.86	3.60	3.38	3.56	3.05	2.93	2.84	2.76
Stored during manuf.	6.14	6.40	6.62	6.44	6.95	7.07	7.16	7.24
Cumul. storage	6.14	12.54	19.16	25.60	32.55	39.62	46.78	54.02

At the end of the production (0.32 years) inventory is at the level of 54.02 lots. The present worth for the remaining inventory can be found by computing the present worth of the maximum inventory continuing over the remainder of the year minus the present worth of a ramp that describes the issuing rate from the inventory. The first part of that computation is a step of 54.4 times \$1000, or:

$$PW_{\text{step}} = 54400 \left[\frac{1 - e^{-.11333(.68)}}{.11333} \right] = \$35,603.$$

The other part is the ramp or:

$$PW_{\text{ramp}} = \$80,000 \left[\left(\frac{1 - e^{-.11333(.68)}}{.11333^2} \right) - \left(\frac{0.68 e^{-.11333(.68)}}{.11333} \right) \right] = \$17,572.$$

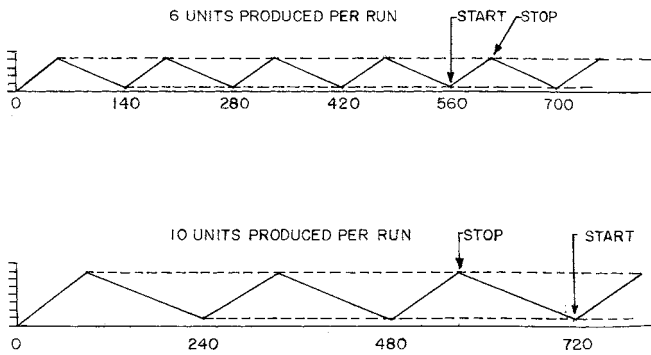

FIGURE 8.1

where the difference is \$18,031. However, that final inventory cost starts at 0.32 years so that the present worth is:

$$PW_{\text{downramp}} = \$18,031 e^{-11333(.32)} = \$17,389.$$

The total inventory present worth using a single production run is calculated as the sum of the first phase during production and the second phase after production or:

$$PW_{\text{inventory}} = \$8,496. + \$17,389 = \$25,885.$$

Two other cost components are the production work present worth of \$7,742 and the single setup of \$180 for a grand total of:

$$PW_{\text{total}} = \$7,742 + 25,885 + 180 = \$33,807$$

Alternative Strategies between These Extremes

There are many alternative production strategies, starting with making 2 items in each run and restarting production every 40 hours of operation time. Based on the learning curve above, the initial production would require 19.92 hours. During the 20.08 hours before restarting production (i.e., 40 hours less 19.92 hours), forgetting would be expected to be very small and so the next learning curve is estimated to start at 9.92 hours for the first unit. Continuing this strategy of 2 lots at a time would result in the annual 2000 h divided by 40-hour cycles between successive production starts for a total of 50 cycles a year. Other strategies of 3, 4, 5, ..., 10 lots of production in each cycle are shown in Figure 8.1. Longer production runs are illustrated along with longer gaps between subsequential runs. Table 8.6 provides additional data on these alternative strategies. It is assumed in this example that the first cycle is the initial production run, so the second cycle production is affected by forgetting after the first cycle, but all subsequent cycles have production times similar to those shown in the second cycle. These cycle times were based on the first cycle's initial time of 10 hours and on the fact that the second and subsequent cycles started production 10 hours before the next lot was needed for issue.

In this general situation, an initial cycle follows the learning curve stated above. Following that, a forgetting curve occurs that shows the amount of learning lost before production restarts. This forgetting curve is based on the calculation 150 operating hours (3 months) as the longest time knowledge is retained. It is assumed here that the time gap between ending production on the n th run and restarting production on the next run will increase forgetting (or decrease learned skill). For the time gap g , the

TABLE 8.6 Production Run-Size Problem with Learning and Forgetting Curves. The 1st Run is 10 h Short to Produce a Minimum Inventory of 0.4 Lots. The 2nd through the Next-to-the-Last Run, Where the Forgetting Curve Occurs, Completes the Year with Zero Inventory and This Last Run is Either Like the 2nd But with 10 h More Time or the Last Run Produces the Remainder of the 80 Units Not Produced Previously with Fixed Run Sizes.

Run Length	No. Runs	Cycle Time	1st Run		2nd Run to N-1th. Run			Last Run	
			Duration	Gap	Duration	1st Unit	Gap	Duration	Gap
1	80.0	25	10.0	5.00	9.925	9.925	15.07	9.925	25.075
2	50.0	50	19.92	20.08	19.65	9.863	30.35	19.65	40.35
3	26.67	75	29.76	35.24	29.23	9.820	45.77	19.64	40.36
4	20.0	100	39.53	50.47	38.72	9.793	61.28	38.72	71.28
5	16.0	125	49.22	65.78	48.18	9.785	76.82	48.18	86.82
6	13.33	150	58.83	81.48	57.63	9.789	92.37	19.58	40.42
7	11.42	175	68.31	96.69	67.38	9.84	107.62	29.46	55.55
8	10.0	200	77.78	112.22	74.52	9.84	125.48	74.52	135.48
9	8.89	225	87.18	127.82	86.44	9.90	138.56	77.77	132.23
10	8.0	250	96.59	143.41	96.27	9.96	153.73	96.27	163.73

fraction $(1 - g/150 \text{ h})$ is multiplied by $(y_1 - y_m)$ and that value is subtracted from y_1 . That computed value is repeated in the next learning curve until the actual curve is lower. This computational procedure of forgetting brings the process back to an earlier value on the original learning curve. For example, suppose the company produced 7 lots at a time. The initial production follows the learning curve from 10.0 down to 9.543 h. The amount learned is $10.0 - 9.473 \text{ h}$ or a learning effect of 0.5275 h. The time gap between two successive production runs is 107 hours. Thus, the fraction computed is $(1 - 107/150)$ or 28.67% of the 0.5275 h or 0.1512 h retained. This is $10.0 - 0.5275 = 9.4725 \text{ h}$ for the restart initial time. Arzi and Shtub (1996) and Dar-El and Vollichman (1996) found that interrupted tasks which are restarted come back to the original learning curves after a short transition period. Their transition (forgetting) period was not precisely described and the one shown above is my conjecture. Table 8.6 shows production durations on the 1st run where the initial learning occurred. On the second and subsequent runs there is some forgetting as reflected by the time required to make the first unit, and the combination of learning and forgetting is reflected by the duration of the 2nd run compared to the 1st run. Note in the 2nd run how the time required to make the first unit decreases down to the case of 6 lots production and thereafter increases. Longer run lengths have greater learning but also longer time gaps between production runs. Between runs of length 6 and 7, the gap effect overcame the longer learning effect.

Specific production and inventory levels are given in Figure 8.2 for the case of producing 7 lots in a production run. Note that this figure shows the 1st and 2nd production runs at the top. At the bottom of this figure are part of the 10th run, the 11th run and part of the last (12th) run. Runs 2 through 11 are identical in character. Since 11 runs each produce 7 lots, the combined production of 77 lots is 3 short of the required 80 lots per year and the final production run completes those 3 lots and inventory goes to zero on New Year's eve. As there are only 3 different types of runs, economic calculations for each of the 3 types are computed separately in Table 8.7. Each separate calculation starts with the temporary assumption that the production started at time zero. Within each production run the initial phase of manufacturing and dispensing inventory, while the final phase is only dispensing inventory. These two phases are computed separately in Table 8.7. Note that all of the coefficients are based on an annual basis and so the time units in the calculations are yearly fractions. These units must agree. Production operations cost of \$24,000 per year uniformly over the actual length of the production phase and the present worth calculations are for a step function. Inventory costs during the production and dispensing phase are an up-ramp whereas during the dispensing phase there is a down-ramp, where present worth is computed as a step at the maximum inventory in that run minus an up-ramp at a cost of \$80,000 per year. Each type is similarly calculated. However, the 2nd run has 10 replications and setup costs, \$180 each, for runs 2 through 12 with 11 replications. The present worth of the final production run is shown under the temporary assumption of a zero time start and then it is corrected for starting

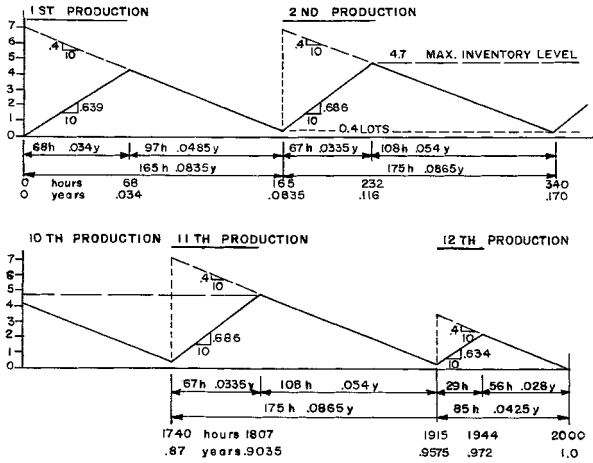

FIGURE 8.2

TABLE 8.7A Present Worth Computations of the 1st Production Run

GENERAL COMPUTATIONS OF THE PRODUCTION-RUN-SIZE PROBLEM

1st Production Run —

Production Labor Cost Present Worth

$$\$12.00/\text{hr} \times 2000 \text{ hrs/year} = \$24,000/\text{year}$$

$$PW = \$24,000/\text{year} \left(\frac{1 - e^{-0.11333(0.0342)}}{0.11333} \right) = \$818.25$$

Inventory Cost During Production — Up Ramp 0 to 0.0342 y-

$$@ .06247 \text{ lots/hr} \times 2000\text{hrs/year} \times \$1000/\text{lot} = \$124,940/\text{year}$$

$$PW = \$124,940 \left(\frac{1 - e^{-.1133(0.0342)}}{.1133^2} - \frac{.0342e^{-.1133(0.0342)}}{.1133} \right) = \$72.63$$

Inventory Cost During Dispensing Down Ramp from .0342 to .04834 y

$$@ 0.04 \text{ lots/hr} \times 2000\text{hrs/year} \times \$1000/\text{lot} = \$80,000/\text{year reaching 4.27 lots inventory}$$

$$PW_{\text{step}} = \$4,270/\text{year} \left(\frac{1 - e^{-0.11333(0.04834)}}{0.11333} \right) e^{-.1133(0.03416)} = \$204.99$$

$$PW_{\text{ramp}} = \$80,000/\text{yr} \left(\frac{1 - e^{-.1133(0.0483)}}{.1133^2} - \frac{.0483e^{-.1133(0.0483)}}{.1133} \right) e^{-.1133(0.0342)} = \$74.82$$

The Total for the 1st Run excluding Setup Cost is:

$$\$818.25 + 72.82 + 204.99 - 74.82 = \$1,021.05$$

0.9575 years instead. Finally, present worth computations of all 3 types of runs, including the initial setup cost, are combined to show the overall present worth for a year.

TABLE 8.7B Present Worth Calculations for the 2nd Production Run of the Learning and Forgetting Example

2nd Production Run (Tentatively Consider Start at Time 0)

Production Labor Cost Present Worth

$$\$12.00/\text{hr} \times 2000 \text{ hrs/year} = \$24,000/\text{year}$$

$$\text{PW} = \$24,000/\text{year} \left(\frac{1 - e^{-0.11333(0.0337)}}{0.11333} \right) = \$806.99$$

Inventory Cost During Production Up Ramp 0 to 0.0337 years

$$@ .06389 \text{ lots/hr} \times 2000\text{hrs/year} \times \$1000/\text{lot} = \$127,780/\text{year}$$

$$\text{PW}_{\text{ramp}} = \$127,780 \left(\frac{1 - e^{-.1133(.0337)}}{.1133^2} - \frac{.0337e^{-.1133(.0337)}}{.1133} \right) = \$72.33$$

Inventory Cost During Dispensing Down Ramp from .0337 y to .0875 y

$$@ 0.04 \text{ lots/hr} \times 2000\text{hrs/year} \times \$1000/\text{lot} = \$80,000/\text{year} \text{ reaching } 4.27 \text{ lots inventory}$$

$$\text{PW}_{\text{ramp}} = \$80,000 \left(\frac{1 - e^{-.113(.0538)}}{.1133^2} - \frac{.0538e^{-.113(.0538)}}{.1133} \right) e^{-.1133(.0337)} = \$114.92$$

This gives a total cost for the 2nd run, excluding setup costs, of:

$$806.99 + 72.33 + 170.72 - 114.92 = \$935.12$$

Combined Costs of Production Runs 2 through 11, which are each identical in cost but are 175 hours (or 0.0865 years) apart temporarily let the start of the 2nd run as time zero with 10 repetitions:

$$\text{PW} = \$935.12 \left\{ \frac{1 - e^{-.1133(0.0865)10}}{1 - e^{-.1133(0.0865)}} \right\} = \$8,951.20$$

Setup Costs of \$180.00 Occur at the Beginning of Each of these Runs, plus at the end of the 11th run, and at the beginning of the first run. Excluding the initial setup, the total amount of PW at the beginning of the 2nd run is

$$\text{PW} = \$180 \left\{ \frac{1 - e^{-.1133(0.0865)11}}{1 - e^{-.1133(0.0865)}} \right\} = \$1,886.20$$

These two cost components sum to $\$8,951.20 + \$1,886.20 = \$10,837.40$

Table 8.8 summarizes the production, setup, and inventory costs present worth for each of the alternative production run lengths from 1 at-a-time to 10 at-a-time production. All of the calculations follow similar to those in Table 8.7 covering a single year. These data show the minimum cost strategy of those considered is making run length of 7 lots per run.

There is an economic principle which reappears in the literature of practitioners, but it is not frequently stated. The principle is, "It is rarely very important to be precise in finding the optimal economic alternative, but it is imperative to be near." The total cost differences between the least cost alternative strategies at producing 7 lots during a production run and those quite similar are quite small. In fact, those differences are likely much smaller than the precision associated with the cost estimates. But differences between the least cost and those alternatives much farther from the minimum cost are very striking. Hence, it is very important to identify the approximate optimum economic choices. There is an ergonomic principle authored by Helson (1949) which is very similar. It is known as his U-Hypothesis and it is: "For most variables of concern in ergonomics, performance, as an inverted function of that variable, is U-shaped. The bottom of the U is nearly flat but the extremes rise almost vertically." Here again, the point is the same. One location at the bottom of the U is much the same as another, but being

TABLE 8.7C General Computations of Present Worth for the Final Production Run at the Minimum Attractive Rate of Return of 11.333% (Continuously Compounded)

The LAST Production Run — temporarily assume 0.9575 years is time 0

Production Labor Cost Present Worth

$$\$12.00/\text{hr} \times 2000 \text{ hrs/year} = \$24,000/\text{year}$$

$$PW = \$24,000/\text{year} \left(\frac{1 - e^{-0.11333(0.145)}}{0.11333} \right) = \$347.71$$

Inventory Cost During Production Up Ramp 0 to 0.0342 y-

@ .0634 lots/hr \times 2000hrs/year \times \$1000/lot = \$126,800/year

$$PW = \$126,800 \left(\frac{1 - e^{-.1133(0.145)}}{.1133^2} - \frac{.0145e^{-.1133(0.145)}}{.1133} \right) = \$13.31$$

Inventory Cost During Dispensing Down Ramp from .972 y to .1.0 y where the maximum inventory there is 2.23 lots, decreasing at 0.04 lots per hour.

@ 0.04 lots/hr \times 2000hrs/year \times \$1000/lot = \$80,000/year reaching 2.23 lots inventory

$$PW_{\text{step}} = \$2,238.60/\text{year} \left(\frac{1 - e^{0.11333(0.028)}}{0.11333} \right) e^{-.1133(0.145)} = \$62.58$$

$$PW_{\text{ramp}} = \$80,000/\text{yr} \left(\frac{1 - e^{-.1133(0.028)}}{.1133^2} - \frac{.028e^{-.1133(0.028)}}{.1133} \right) e^{-.1133(0.145)} = \$31.24$$

The Total for the 1st Run excluding Setup Cost is:

$$\$347.71 + 13.31 + 62.58 - 31.24 = \$392.35$$

Now correcting for the temporary assumption and finding the present worth of the last production run in terms of the actual time zero is:

$$\$392.35 e^{-.11333(0.9575)} = \$350.31$$

Completing the Calculations

Adding the Initial Setup Cost of \$180.00 plus the 1st Run Cost Plus the Last Run Cost Plus the Intermediate Runs:

$$\$180.00 + 1,021.05 + 10,837.40 e^{-.1133(0.0835)} + 350.31 = \$12, 106.68$$

TABLE 8.8 Summary of Production and Inventory Costs

Number Made per Run	Production Work PW	Setup Cost PW	Inventory PW	Total PW
1	9,074	13,614	10.00	22,688
2	8,858	6,726	666	16,251
3	10,321	5,246	742	16,309
4	9,825	3,789	840	14,454
5	9,790	2,970	908	13,668
6	9,547	2,441	1,033	13,020
7	8,853	2,069	1,469	12,396
8	9,397	1,802	1,459	12,658
9	9,932	1,593	1,660	13,186
10	8,845	1,428	3,134	13,310
...				
80	7,742	180	25,885	33,807

TABLE 8.9 Evaluating Alternative Learning Curves from Component Speeds and Asymptotes

Asymptote	$\alpha = 0.98$	$\alpha = 0.95$	Speed Savings
$y^* = 6$ h	0.320 yrs \$7546	0.279 yrs \$6599	.041 yrs \$947
$y^* = 5$ h	0.300 yrs \$7083	0.249 yrs \$5897	.051 yrs \$1186
Asymptote Savings	0.0200 yrs \$463	0.030 yrs \$702	.071 yrs \$1649

outside the U-bottom can be a design tragedy. This observation describes a strong ergonomic-economic interaction. Nadler (1970) strongly advocated searches for optimum designs.

Evaluating Training Programs

One feature of training programs that has economic consideration is the time change that a training program can have on production work following training. It should be stated that other features have economic significance as well. When the training program reduces errors in the operations, that error reduction is a valuable asset as well, but this discussion focuses only on the performance time. A rather elementary approach to evaluating training programs is to find Present Worth changes in the learning curve with and without the training program. In the situation above, for example, the full learning curve over 80 lots was evaluated at:

$$PW = \frac{\$24,000}{.11333} \left[1 - e^{-.11333(0.32014)} \right] = \$7,546$$

just for direct labor costs during a single annual production run.

In considering a training program, the concentration could be on faster learning and a reduction in the asymptote. A lower asymptote usually involves finding a change in the method of assembly and perhaps new jigs and fixtures, but quicker learning can sometimes be achieved by pointing out the things to be aware of and some of the things assemblers do wrong. Let us say that the ergonomic manager suggested that they should seek both a quicker rate of learning and a lower final asymptote. For an improvement rate, the ergonomic team targeted the learning rate improvement in terms of lowering α from 0.98 to 0.95. They also targeted an asymptote reduction from 6 hours per lot to 5 hours. If the team is able to achieve both targeted features in their training program, then the total learning curve at $\alpha = 0.95$ and $y^* = 5$ hours is:

$$Y_{80} = \frac{1 - 0.95^{80}}{1 - 0.95} [10 - 5] + 5(80) = 498. \text{ h}$$

which is equivalent to 0.2492 years based on 2000 production hours per year. The present worth of just the direct labor cost is:

$$PW = \frac{\$24,000}{0.11333} \left[1 - e^{-0.11333(0.24917)} \right] = \$5,897.$$

As a first-pass economic test, this training program initially passes this test if the cost of it was less than the cost savings of \$7,546 – \$5,897 or \$1,649 per presentation. It is interesting and often useful to investigate savings due to the learning-speed improvement and the asymptote improvement as shown

in Table 8.9. The two different alpha values describe speed differences, with a smaller alpha denoting faster learning and the lower γ^* describing a lower asymptote. It is clear from a review of the results in Table 8.9 that savings are not linear with the causes of savings. But it is equally clear from a review of those tabled data that a smaller α and a smaller γ^* have synergistic effects. The same reduction in α causes a greater effect on performance times with a smaller γ^* and conversely.

8.7 Effects of the Lack of Manufacturing Specification on Repair

One of the cost components that is gaining larger importance because of rapid increases over the past several decades is the cost of repair. Repair times are becoming particularly large due to the lack of ergonomic attention associated with repair and maintenance activities during new product design. A case in point is when companies in charge of the final component assemblies fail to recognize what they are doing in design is insufficient. Many companies who are trying to sell a product competitively against most aggressive competitors often tell the vendors that as long as they match interconnecting features and keep the price least, that they will be favored. In this situation things look good until there is a repair to be made. It is then that the repair persons suddenly find that a component piece has many different bolt or screw sizes. As a result the repair person needs additional wrenches in the repair. As the repair person is disassembling the component to get to the failed component part, he or she tries to use the wrench in hand to remove a nut but finds that it is the wrong size. This situation requires added time from the operator doing the repair work to discard the wrong tool and to identify the correct tool size before starting to remove that component. For every change in bolt size, there is at least a change in tool and often several before the correct one is found. In addition, many repair crews have assistance made up by the support people who put together the kits those people use. When the repair people do not have the correct size or type of wrench in their kit, they either must work with an inferior wrench (screwdriver or other tool) while the activity is being performed or they must stop that repair activity and come to the tool dispensary and retrieve the correct tool before returning to the repair activity and correctly performing the repair activities as they should be done. That result is often required because the company simply ignores what vendors do on product designs that do not affect the interface connections of the prime contractor.

There are numerous repair principles for greater economic effectiveness. One is simply, *arrange activities in a sequence or create sequential activities that require the same tools*. Note that the reason for this principle is that every time this rule is violated, the repair person must put down one tool and select another for use. That simple tool put down and subsequent pickup simply takes unnecessary time to perform. When people ask me if they need to think about time-and-motion principles all the time, I merely mention that the answer is “yes” if they wish to be considerate and more so if they wish to be successful. Now one almost always faces the tradeoff of an existing choice of some design, bolt size, or screw type, with regard to additional connector decisions. That leads to another principle which is, *Keep the number of different types of screws, nails, and other connectors as small as effectively possible so that the tool kits can also be minimized*. Tool kit sizes are particularly important when the item to be repaired is large enough that the repair person must be transported to it rather than the other way around. In that case a missing tool in the tool kit necessitates another trip from the object or thing under repair to the tool repository and back again.

Another ergonomic feature of maintenance and repair is that those maintenance and repair activities are so infrequent that memory often fails the repair person. This is a good situation to use a **job aid**, that is, a device which enables one to perform a task which one could not do before and to do it in the first try (Wulff and Berry, 1962). Job aids can be as simple as a chart that shows garage mechanics where to lubricate the suspension of an automobile of a particular make, year, and model. More extensive job aids may consist of elaborate productions which tell an operator how to disassemble, diagnose, fix, and reassemble a complex machine.

8.8 Parallel Processing Economics

Ergonomists frequently face the task of assigning multiple assemblers, pairs of machines and their operators, and multiple processors to a job because no single assembler, machine, or processor could handle the requirements alone. The principal ergonomic-economic question is which pairs should be assigned to the job. An answer lies with an old economic principle which states, "When multiple devices must be used concurrently, then the optimum economic relationship is for the multiple devices to operate such that marginal costs of each are equal." This principle does not specify the number of devices except being more than one (see Buck and Askin (1983) for a more complete development of this principle). Practical experience suggests that the number should be minimum to handle the job.

In the ergonomics of "crews" or "teams," it should be recognized that crew activities in most instances involve parallel operations. Boat crews have crew members, rowing and sailing crews have seamen attending to the sails, rudder, and boat trim. Similarly, in industry, order-picking crews take customers' orders and go out into the inventories and fill them. Loading and unloading crews take objects from one or more locations and put them into a vessel for shipment or vice versa. In any case, one must select N crew personnel and assign them to the activities to be performed. The question addressed here is the selection of personnel or personnel and machines where it is assumed that all crew personnel essentially perform the same functions. That is, specialties among crew members (e.g., a punter in football or a center in basketball) is not addressed.

In the discussion to follow, the subscript symbol i is an identifier of a processor consisting of a particular operator and a particular machine-tool. While a different human operator with the same machine-tool will have a different identifier, a distinct pair of processors are two different persons and two different machine tools. To illustrate this situation, let us assume that the cost of each parallel processor followed the function.⁵

$$y_i(x_i) = \alpha_i^{x_i} y_i(0) + \beta_i \frac{1 - \alpha_i^{x_i}}{1 - \alpha_i} \quad (15)$$

where

i = an index denoting specific processors,

x_i = the workload assigned to the i th processor,

α_i = the rate-of-change parameter as a function of the exponential workload x_i ($\alpha_i > 1$),

β = the scale parameter, and

$y_i(0)$ = the setup cost.

Although this cost function appears to differ from the one used to describe the learning curve, it is in the same family and the right-hand side equates to:

$$y_i(x_i) = \alpha_i^{x_i} y_i(0) - \frac{\alpha_i^{x_i} (\beta_i)}{1 - \alpha_i} + \frac{\beta_i}{1 - \alpha_i}$$

where the last term is equivalent to y^* and the middle term is essentially α^{xy^*} . Accordingly, Equation (15) is the same as Equation (12), verifying that the function is of the same family. Marginal costs of this function are shown in Equation (13) or:

$$\Delta y_i(x_i) = \alpha_i^{x_i} (\alpha_i - 1) [y_i(0) - y_i^*] \quad (16)$$

⁵The fundamental function here is the same as the one used as a learning curve above. Goldberg (1961) provides details. A principal difference here is that the alpha (α) parameter here is a value greater than unity so that costs increase with the amount of work assigned x in an exponential manner away from y^* . Accordingly, y^* is not an asymptote in this model except in a beginning sense, but it is an important parameter.

where y_i^* is defined as:

$$y_i^* = \frac{\beta_i}{1 - \alpha_i} \quad (17)$$

Equation (16) describes the marginal costs of different combinations of human operators with differences in skills and different machine-tools which also have different capabilities. If two distinct pairs of processors are under consideration (say $i = 1$ and $i = 2$) and their marginal costs are equal, then it follows that:

$$\alpha_1^{x_1} (\alpha_1 - 1) [y_1(0) - y_1^*] = \alpha_2^{x_2} (\alpha_2 - 1) [y_2(0) - y_2^*]$$

Bring the two alpha factors with exponents to the left-hand side and the rest to the right as:

$$\frac{\alpha_1^{x_1}}{\alpha_2^{x_2}} = \frac{(\alpha_2 - 1) [y_2(0) - y_2^*]}{(\alpha_1 - 1) [y_1(0) - y_1^*]}$$

Everything on the right-hand side of the equation above is known so that it results in the constant which can be called K. The result, with a little simplification, is:

$$\alpha_1^{x_1} = \alpha_2^{x_2} K$$

When the above equation is converted to logarithmic form, x_1 and written in terms of x_2 as:

$$x_1 = x_2 \frac{\log \alpha_2}{\log \alpha_1} + \frac{\log K}{\log \alpha_1} \quad (18)$$

Equation (18) shows the workload to processor 1 (or x_1) as a linear function of the workload to processor 2 (or x_2) because the two fractions in Equation (18) are constants. So long as the workloads to the two processors maintain the relationship in (18), no better combination of those two processors can be obtained. Figure 8.3 describes the workload assigned to processor 1 as a function of that assigned to processor 2. At x_2 equals 0, Equation (18) has the constant ratio of $\log K / \log \alpha_1$ as the intercept. Then for each unit increase in the workload to processor two (x_2), the workload to processor one (x_1) changes at the rate of $\log \alpha_2 / \log \alpha_1$. That optimum x_1^* to x_2^* relationship is:

$$x_1^* = \frac{\text{Log } \alpha_2}{\text{Log } \alpha_1} x_2^* + \frac{\text{Log } K}{\text{Log } \alpha_1} = 0.6949 x_2^* - 3.0908$$

where the intercept of the $x_1^* - x_2^*$ relationship is negative but the slope is positive. The equation above also denotes that the minimum amount of workload to x_2 is 4.45 units when x_1 and x_2 are used together (otherwise x_1 or x_2 is used separately). Those downward sloping lines in Figure 8.3 describe contours with equal sums of x_1 and x_2 . When the sum of x_1 and x_2 adds up to the needed amount Q, then those values of workload describe the workloads which will complete the job, and the sum of the two cost functions describes the cost. However, the cost sum of both processors, as Figure 8.3 shows, is only optimum economically for that combination of humans and machines. If those two person-machine-tool combinations are the only ones available, then no other combinations of two person-machine-tools are less costly, but clearly the use of a single person and machine-tool can be. In fact, costs of processors 1 and 2 are described individually below as a function of the assigned workload. Results above show that processor 1 starts off less costly but between 6 and 7 units of workload individually, processor 2 becomes

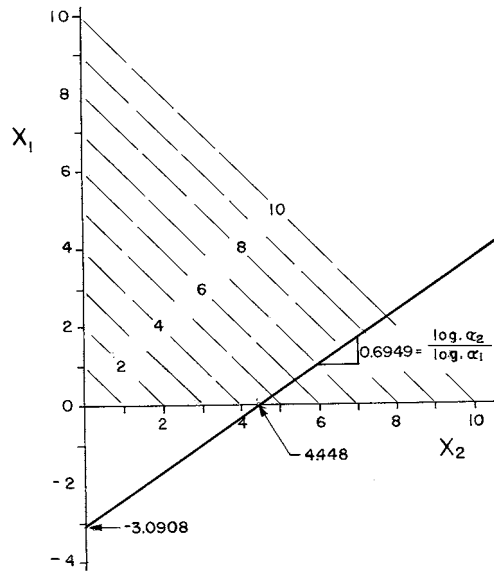

FIGURE 8.3

less costly. In fact, at about 6.32 units of workload, operating costs of the two individual processors are approximately equal. Accordingly, it is more economical to use processor 1 alone so long as the workload is below 6.32 units. From that level upward, first use processor 2 alone. At about 10.7 units of workload, it becomes more economical to use both processors 1 and 2 together at the optimal combination. At that point forward, both processors should be used together as stated above. While it is purely conjecture, one may wonder if people similarly use a form of concurrent processing of attention by allocating attention between pairs of tasks on an approximate procedure resembling the principle above.

$x_i =$	1	2	3	4	5	6	7	8
$y_1(x_i) =$	33.0	36.9	42.0	48.6	57.1	68.3	82.8	101.6
$y_2(x_i) =$	43.0	46.6	50.9	56.1	63.3	69.8	78.8	89.5

8.9 Using Economic Principles to Guide Ergonomic Studies of Automated Highway Design

On occasion, ergonomists are called upon to help develop new public systems or to assist in creating new laws regulating industrial operations, usually in health and safety. Those situations usually do not have easy precedents to follow. The only other recourse is for ergonomists to follow reasonableness and evolution. There is perhaps no better guide than selecting the less costly alternative as a starting point. The case below involves the design of a new form of highway system where the conceptual design is uncertain. Using the reasonableness and evolution principle, it was assumed that the new system would be as close to our existing systems as was possible without jeopardizing the fundamental nature of the concept.

For a couple of decades, highway people have dreamed of having an automated highway system (AHS) where a computer could control the vehicles. Part of this dream was a fantastic reduction in automobile accidents. Another part was an equally fantastic increase in highway capacity particularly around our large cities where huge numbers of drivers enter the city in the mornings and leave each evening. It is even more obvious that the urban AHS also has the problem of very expensive land so that conventional expressways cannot be economically used to solve the problem of excessive traffic volumes. However, it is even less clear what alternative design of an AHS is even reasonably feasible. The story to follow is a

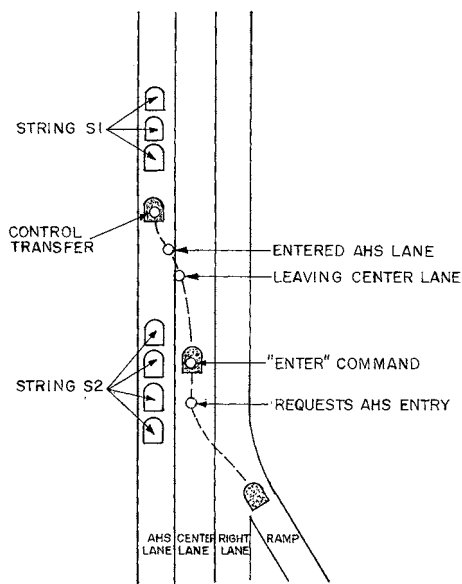

FIGURE 8.4

result of an initial effort by the Federal Highway Administration (FHA) of the U.S. government in an ergonomic research effort to explore this question. (See Buck and Yenamendra, 1996.)

In an initial examination of the highway economics by the AHS research group, it became evident that it might be possible for a relatively low-cost version of the AHS concept to work and so this group of researchers first focused on that concept. If the initial experimentation proved otherwise, then an alternative AHS with greater investments and expenses could be examined. Although we are referring to the initial version as low-cost, that is only relative to the other versions. Costs of this version will be substantial because of extensive computers and sensor equipment, as well as at least one added traffic lane on the existing expressways and bridges. The envisioned concept was that the traditional two-lane (each way) expressway would be expanded by a single third lane in each direction which would be used exclusively by AHS-outfitted vehicles. This added lane is expected to cost at least $\$3$ to $\$4 \times 10^6$ per mile in each direction for just the concrete. While this configuration is not inexpensive, it is vastly less expensive than duplicating the existing interstate roadways as an alternative plan proposed.

Figure 8.4 illustrates this AHS concept with strings of AHS vehicles traveling in the left-most lane with gaps between successive strings. The right two lanes contain non-AHS vehicles and AHS vehicles either waiting to join the other AHS vehicles, departing from the AHS lane for an exit ramp, or AHS vehicles who simply choose to remain in manual mode for one reason or another. That schematic in Figure 8.4 illustrates the entering AHS vehicle coming from the on-ramp to the right lane of the expressway, crossing over to the center lane before attempting entry into the AHS lane. It was assumed that the entry procedure required the driver to first request entry, then the central computer would check the vehicle for adequacy to drive in AHS mode, and if the checkout was adequate, the computer would direct the vehicle to enter immediately behind a passing string of AHS vehicles. The driver of the entering vehicle was instructed to accelerate as rapidly as possible after entry until the computer took over. One of the modes of transferring control from the driver to the central computer was automatic as soon as the first wheel crossed into the AHS lane. The other mode was where the driver manually shifted control by pushing a button on the steering wheel. It was felt that there may be legal reasons for a manual mode of control transfer even though that mode may be slower.

It was assumed that AHS cars left the AHS lane by requesting to exit, splitting the string of vehicles so that the exiting vehicle was last, and then manually driving into the center lane. Experiments in an automobile simulator verified that both older and younger drivers could perform the maneuvers of both

entering and exiting AHS. Almost all subjects experienced difficulties during exiting. The difficulties encountered during exiting were almost always due to difficulties in seeing slower manually controlled vehicles in the middle lane due to the vehicles immediately ahead of the exiting car. As the driver of the exiting car was seated on the left-side of the car and exiting maneuvers necessitated rightward movements of the vehicle, another car could be a short distance ahead and not be very visible due to intervening cars. This difficulty was compounded with greater speed differences between the AHS design speeds and those allowed for manually controlled traffic because of the short time between entry and encountering a vehicle in the middle lane. Those difficulties appeared to be correctable with some form of vision aiding.

Entering maneuvers posed a different approach. The maneuvers necessitated the gaps between successive strings of vehicles driving along the AHS lane in order to get the entering vehicle safely into that lane. If the gap was too small, then the entering vehicle could not accelerate rapidly enough to the AHS design speed before the following vehicles would catch up to the entering vehicle. Clearly, the greater the differential in speed between the center lane and the AHS design speed, the longer it takes a vehicle to accelerate to the AHS design speed and the greater the gap needed between successive AHS strings of vehicles. In fact, the entering car was traveling at 55 miles per hour in the center lane and then acceleration to any of three different AHS design speeds of 65, 80, and 95 miles per hour requires respective minimum string-to-string distances of 32.5, 121.5, and 335.0 meters. That is, the gap at the AHS design speed of 80 miles per hour is almost 3.75 times that at 65 miles per hour and the one at 95 miles per hour is 2.76 times the length of the gap at 80 miles per hour or 10.3 times the one at 65 miles per hour. It was envisioned that the controlling computer could create an opening for a new vehicle by slowing down vehicles behind the spot targeted for the entering vehicle to a sufficiently long gap. As the vehicle entered at a lower speed and started to accelerate, the faster vehicle behind would catch up and close the gap. Our experiments on people accommodating with this entry play proved that they could perform the maneuvers extremely well. In fact, the degree to which they could perform the entries came as a surprise.

After the vehicles entered the AHS lane, they were placed in collections of up to four-car strings which would move at the AHS design velocity with this minimum gap. Minimum gaps were about 1/16 seconds and that time interval translated into about 3 to 5 meters separation distance. When those four-car-strings have minimum gaps within strings and inter-string distances as shown above for these three design speeds, the number of vehicles per hour in the AHS lane at this maximum theoretical case would be 7,551, 3,531, and 1,825 vehicles per hour for the AHS design speeds of 65, 80, and 95 miles per hour, respectively. As a result, the lowest of these three AHS design speeds was recommended with this particular design for greater highway capacities. Note that the capacities described above are theoretical upper limits rather than reasonable capacity estimates. But at the recommended AHS design speed, that theoretical capacity is 441% greater than the upper limit of conventional traffic, which is about 1712 vehicles per hour. If the practical upper limit of AHS capacity was only 3/4 of the theoretical limit and there were ample AHS outfitted vehicles to use the single AHS lane, the increase in capacity due to AHS capability would be expected to be over 175% of that with an added third lane of conventional traffic. This economic information would have been impossible without the ergonomic information that people could perform the entry and exit tasks and the delay in AHS traffic they cause during the entry.

These data demonstrate that the AHS configuration is feasible and that this lowest-cost plan can be economically viable, but it does not show that another configuration may be better. For example, another configuration could consist of a partial fourth lane which is added at locations where entry and exit maneuvers are to be performed and that lane would be long enough to allow vehicles to accelerate to the AHS design velocity and decelerate from it to 55 miles per hour. This new configuration would increase AHS capacity more at the higher speeds, but that added capacity is conjecture without confirming ergonomic data. If the ergonomic testing had been carried on assuming a more expensive version of AHS, the public would have insisted on running further ergonomic tests at lower-cost versions of AHS before starting the long political journey toward the AHS. As it is, future ergonomic studies can proceed

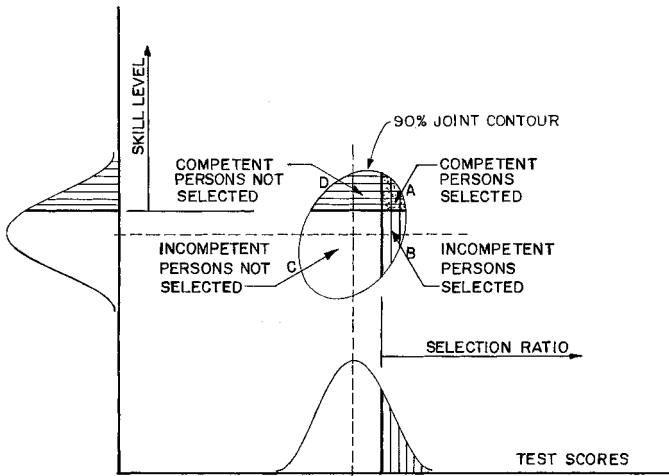

FIGURE 8.5

to fine-tune the eventual AHS configuration, (e.g., the acceleration lane addition) now that initial feasibility appears evident.

8.10 Personnel Selection Economics

Personnel selection involves a selection basis that may consist of a test, questionnaire, and/or interview evaluations. It is assumed here that applicants for the jobs have been administered one or more tests, questionnaires, and/or an interview and their composite scores are shown as the horizontal axis in Figure 8.5. The vertical axis of this figure denotes job performance scores, and in the middle, between these axes, are the relative frequencies of persons with competent and subcompetent performance such as the upper and lower regions around the dashed line. The composite scores from the interview-testing instruments separate the persons selected on the basis of those scores on the right of the dashed line who were selected from those on the left region where people were not. A vertical line separating left and right regions shows the percentage of persons selected on the basis of these scores (i.e., selection ratio).

The composite of the selection ratio and the minimum competency level yields four regions which are marked:

- A. Competent persons selected
- B. Incompetent persons selected
- C. Incompetent person rejected by the test/interview
- D. Competent persons rejected

The ellipse shown in this figure is a 95% contour line of a bivariate normal distribution. The narrowness of the shorter ellipse axes relative to the longer axes depends upon the correlation coefficient r between test scores and competency level. That coefficient is often called the *validity coefficient*. As r approaches unity, a far greater proportion of the selected persons fall in the A and C regions rather than the B and D regions. In fact a special statistic Z is the fraction of persons selected who are expected to be competent. Of the persons in regions A or B, Z is the expected fraction who are in region A. This Z statistic changes with the three variables:

1. Selection ratio
2. Validity coefficient
3. The proportion of the population who can perform satisfactorily on the job

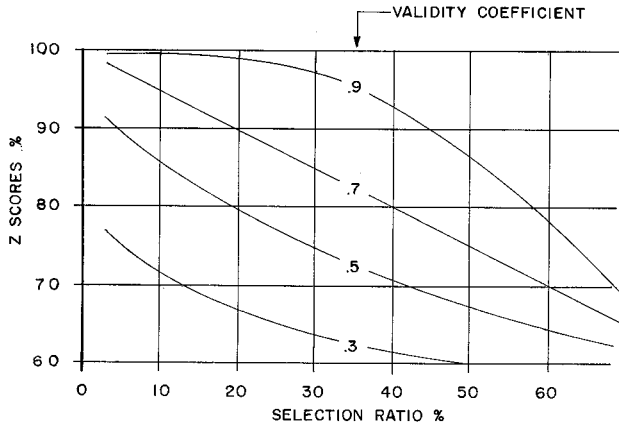

FIGURE 8.6

Figure 8.6 shows Z statistics as a function of the first two variables but with the third set with the competency level 50% of the population. That figure shows slopes decrease with greater selection ratios (i.e., lower percentages with greater fractions selected). Figure 8.6 also shows that Z-scores drop more gradually with small selection ratios when validity coefficients are large, but when r is small, there is greater immediate decrease in Z-scores with low selection ratios. For example, if there were 50 applicants and a selection ratio of 40%, 20 persons with the highest test–interview scores would be selected. If that test–interview rating has a validity coefficient $r = 0.7$ for a job where 50% of the people could perform it satisfactorily, Figure 8.6 shows that one should expect that 80% of those selected would perform in a satisfactory manner, or 16 of the 20 persons. Without the test and interview rating, the best one could expect is that 10 of the 20 persons could perform the job. In that and other cases of 50 applicants, all with jobs which 50% of the population could perform, the expected numbers of those selected who are expected to be satisfactory (S) and unsatisfactory (U) are indicated as:

Validity Coeff. r	Selection Ratios							
	40%		30%		20%		10%	
	S	U	S	U	S	U	S	U
0.9	18.4	1.6	14.4	0.6	9.8	0.2	4.95	0.05
0.7	16.0	4.0	12.6	2.4	9.0	1.0	4.75	0.25
0.5	14.4	5.6	11.1	4.9	7.8	2.2	4.25	0.75
0.3	12.4	7.6	9.6	5.4	6.7	3.3	3.60	1.40
0.1	11.0	9.0	8.4	6.6	5.6	4.4	2.85	2.15
Total Selected	20.0		15.0		10.0		5.0	

If a company observed that new hires who did not seem to perform well at the start would simply quit during the first two weeks, they would recognize that the cost associated with hiring people who could not perform well was nearly a constant equal to about two weeks pay and benefits, plus the test cost. Thus, the expected cost per selected applicant is approximately $C(1 - Z)$. At approximately \$12 per hour, two weeks pay amounts to around \$960. Now as management selects a better test–interview procedure, Z increases and this cost decreases. While a better test–interview procedure decreases the cost associated with hiring the wrong people, it also increases the cost of testing. If the cost of testing was estimated to be a function of the validity coefficient or $25e^{3r}$, the question remains as to the most

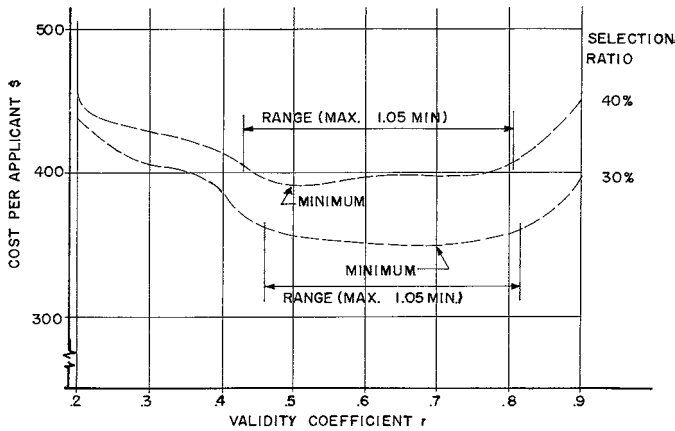

FIGURE 8.7

economical cost of the coefficient r . Figure 8.7 shows cost as a function of the validity coefficient r for the sum of the selection error cost and the test cost separately at 30 and 40% selection ratios. This illustration describes a decreasing total cost as long as the decreasing error cost is greater in magnitude than the added test cost and that total cost decreases to a minimum at $r = 0.7$ (for 30% selection ratio) and at $r = 0.5$ (at a 40% selection ratio). That figure also shows a range of r values where the total cost is within 5% of the minimum cost. This range of validity coefficient values is from a mid 0.4 value to slightly more than 0.8. Since it is difficult to estimate costs closer than 5%, total costs are frequently uncertain within 5%, so it is unimportant to find the optimum r value precisely, but it is important to find the approximate range of optimum r values. Here again, economics is like Harry Helson's (1949) U-Hypothesis in ergonomics in which he states that "human performance is an inverted U-shape as a function of most variables of concern; the bottom of the U is nearly flat but the extremes fall strikingly." In both disciplines one seeks to be at the nearly flat U-bottom but the precise optimum is unimportant.

8.11 Final Remarks

Ergonomists compete with many parts of the company for limited amounts of capital available to improve the company. In order to compete effectively, ergonomists must identify and quantify the economic advantages and show them to be more important than other contenders if they expect to receive the investment funds. Accordingly, ergonomists must learn to identify important economic opportunities and they must learn to seize those with potential and then to get the greatest potential from them. While that requires art and ergonomical technology to find appropriate solutions, it also requires knowledge, prediction capability, and the forms of analysis shown above.

One of the pragmatic principles of economics is to look for some short-range optimum economic solutions to be sure the optimum range is identified, but one does not have to be dogmatic about specifying the very best. Solutions in the optimum ballpark are often indistinguishable from one another, and usually they are quite stable under expected variations. Another economic principle is to use single resources if possible, but if not, use multiple resources with balanced marginal costs.

Economics was formed from the study of people and logic. Things which are economically sound are usually humanistically balanced if realistically represented. For these very reasons, some of the ergonomic theories of how people behave come from economic theory and related principles. That is why there are economic-ergonomic interactions and why both specialists of economics and ergonomics should be looking for them.

References

- Anderson, D. (1990) *Design for Manufacturability*, CIM Press, U.S.A.
- Arzi, Y. and Shtub, A. (1996) Learning and forgetting in high cognitive and low cognitive tasks, *Advances in Applied Ergonomics*, A. F. Ozok and G. Salvendy (editors), U.S.A. Publishing, 672-675.
- Au, T. and Au, T.P. (1992) *Engineering Economics for Capital Investment Analysis*, Second edition, Prentice Hall, Englewood Cliffs, New Jersey.
- Bevis, F. W., Finnear, C., and Towill, D. (1970) Prediction of operator performance during learning of repetitive tasks, *International Journal of Production Research*, 8, 293-305.
- Buck, J. R. and Hill, T. W., Jr. (1975) Alpha/beta difference equations and their zeta transforms in economic analysis, *American Institute of Industrial Engineers Transactions*, 7, 3, 330-358.
- Buck, J. R., Tanchoco, J. M. A., and Sweet, A. L. (1976) Parameter estimation methods for discrete exponential learning curves, *American Institute of Industrial Engineers Transactions*, 8, 2, 184-194.
- Buck, J. R. and Askin, R. G. (1983) On the economic loading of parallel processes, *The Engineering Economist*, 29, 1, 13-32.
- Buck, J. R. and Cheng, S. W. J. (1993) Instructions and feedback effects on speed and accuracy with different learning curve functions, *Institute of Industrial Engineers Transactions*, 25, 6, 34-47.
- Buck, J. R. and Yenamedra, A. (1996) Ergonomic issues on entering the automated highway system, Chapter 18 in *Ergonomics and Safety of Intelligent Driver Interfaces*, I. Noy, editor, Lawrence Erlbaum Associates, Mahwah, NJ, 309-328.
- Dar-El, E. and Vollichman, R. (1996) Speed v/s accuracy under continuous and intermittent learning, *Advances in Applied Ergonomics*, A. F. Ozok and G. Salvendy (editors), U.S.A. Publishing, 676-682.
- DeGarmo, E. P., Sullivan, W. G., and Canada, J. R. (1984) *Engineering Economy*, 7th Edition, Macmillan, New York.
- de Jong, J. R. (1957) The effect of increasing skill on cycle time and its consequences for time standards, *Ergonomics*, 1, 51-60.
- Drury, C. G. (1988) The human as optimizer, *Contemporary Ergonomics*, E. D. Megaw, editor, Taylor & Francis, London.
- Fabrycky, W. J., Thuesen, G. J., and Verma, D. (1998) *Economic Decision Analysis*, Third Edition, Prentice Hall, Upper Saddle River, New Jersey.
- Fabrycky, W. J., Thuesen, G. J., and Verma, D. (1998) *Economic Decision Analysis*, Third Edition, Prentice Hall, Upper Saddle River, New Jersey.
- Glover, J. (1966) Manufacturing process functions ii: selections of trainees and control of their progress, *International Journal of Production Research*, 8, 293-305.
- Goldberg, S. (1961) *Introduction to Difference Equations*, John Wiley & Sons, Inc., New York.
- Hax, A. C. and Majluf, N. W. (1982) Competitive cost dynamics: the experience curve, *INTERFACES*, 12, 5.
- Helson, H. (1949) Design of equipment and optimal human operation, *American Journal of Psychology*, LXII, 4, 473-497.
- Hill, T. W., Jr. and Buck, J. R. (1974) Zeta transforms, present value, and economic analysis, *American Institute of Industrial Engineers Transactions*, 16, 2, 120-124.
- Hutchings, B. and Towill, D. R. (1975) An error analysis of the time constraint learning curve model, *International Journal of Production Research*, 13, 2, 105-135.
- Nadler, G. (1970) *Work Design: A Systems Concept*, Revised Edition, R. D. Irwin, Inc., Homewood, IL.
- Nanda, R. and Adler, G. editors, (1977) *Learning Curves Theory and Applications*, Monograph 6, American Institute of Industrial Engineers, Norcross, GA.
- Navon, D. and Gopher, D. (1979) On the economy of the human processing systems, *Psychological Review*, 86, 254-255.
- Newnan, D. G. (1991) *Engineering Economic Analysis*, 4th edition, Engineering Press, San Jose, CA.
- Newnan, D. G. (1996) *Engineering Economic Analysis*, Engineering Press, San Jose, CA.
- Park, C. S. and Sharpe-Bette, G. P. (1990) *Advanced Engineering Economics*, John Wiley & Sons, New York.

- Pew, R. W. (1969) The speed-accuracy operating characteristic, *Acta Psychologica*, 30, 16-26.
- Pegels, C. C. (1969) On startup learning curves: an expanded view, *American Institute of Industrial Engineers Transactions*, 1, 3, 216-222.
- Remer, W. S., Tu, J. C., Carson, D. E., and Ganiy, S. A. (1984) The state of art of present worth analysis of cash flow distribution, *Engineering Cost and Production Economics*, 7, 4, 257-278.
- Rose, L., Ericson, M., Glimskar, B., Nordgen, B., and Ortengren, R. (1992) Ergo-index. development of a model to determine pause needs after fatigue and pain reactions during work, *Computer Applications in Ergonomics, Occupational Safety and Health*, M. Mattila and W. Karwowski, editors, North Holland, Amsterdam, The Netherlands.
- Snoddy, G. S. (1926) Learning and stability, *Journal of Applied Psychology*, 10, 1-36.
- Tanchoco, J. M. A., Buck, J. R., and Leung, L. C. (1981) Modelling and discounting of continuous cash flows under risk, *Engineering Costs and Production Economics*, 5, 205-216.
- Theusen, G. J. and Fabrycky, W. J. (1989) *Engineering Economy*, 7th edition, Prentice-Hall, Englewood Cliffs, NJ.
- White, J. A., Agee, M. H., and Case, K. E. (1989) *Principles of Engineering Economic Analysis*, 3rd edition, John Wiley & Sons, New York.
- Wickens, C. D. (1992) *Engineering Psychology and Human Performance*, Second Edition, HarperCollins Publishers, New York.
- Wright, T. P. (1936) *Factors Affecting the Cost of Airplanes*, *Journal of Aeronautical Science*, 3, 122-128.
- Wulff, J. J. and Berry P. C. (1962) Aids to job performance, *Psychological Principles in System Development*, R. M. Gagne and A. W. Melton, editors, Holt, Rinehart and Winston, New York.

9

The Cost Benefit of Ergonomics: A Corporate Perspective

9.1	Why Do Organizations Feel They Need Ergonomics?	9-2
	Money • Employee Complaints • Regulatory Concerns • Production/Quality Concerns	
9.2	What Are the Costs Associated with Ergonomic Mismatches?.....	9-3
	Workers' Compensation Claim Costs Direct Claim Costs • Indirect Claim Costs • Measuring Claim Cost • The Concept of Fully Developed Losses • Salary Continuation Expenses (LTD/STD) • Lost Workdays/Restricted Workdays • The Cost of Turnover • Estimating the Probability and Value of Loss	
9.3	Methods for Justifying Ergonomic Interventions.....	9-8
	What Is a Cost Benefit Analysis? • Payback Method • Internal Rate of Return • Present-Value Method • Ergonomics and Productivity	
9.4	The Influence of Corporate Culture on Cost Benefit Analysis	9-10
	Organizational Culture and Values • Demonstrating and Communicating Safety and Health Values • Advances in Economic Analysis • Value Chain Analysis • Cost Driver Analysis • Competitive Advantage Analysis • Summary of Costs and Benefits • Summary and Conclusion	
9.5	Justifying Ergonomics Initiatives — Case Studies.....	9-14
	Travelers Tennessee Nursing Home Study • Vehicle Subassembly Plant Ergonomics Success Story • Post-Injury Ergonomics Intervention for a Chronic Carpal Tunnel Case	

William E. Lischeid
Travelers Insurance Company

David J. Roy
Travelers Insurance Company

“I have not been able to discover that repetitive labor injures a man in any way. I have been told by parlor experts that repetitive labor is soul, as well as body-destroying, but that has not been the result of our investigations.” — Henry Ford¹

The great automotive pioneer Henry Ford expressed the above opinion in 1922. What we know today about the soul and body-destroying nature of “repetitive labor” and its associated science, ergonomics, is much more definitive than Henry Ford could have ever imagined. While recent ergonomic investigations, discoveries, and understandings of the adverse affects of repetitive tasks conducted by Ford Motor Company and researchers worldwide have moved us far beyond the opinions of a true industrialist, there

are still too many senior executives and managers in business and industry today echoing these past opinions. They have subscribed to the Fordian school of thought of yesteryear without appreciating the evolution of the science of ergonomics and the significant cost that repetitive labor can have on the risk of injury and their own bottom line.

Without a carefully conceived method of justifying the cost of ergonomic improvements, ergonomists will continue to find resistance to the science and the benefits that it can bring to the modern workplace. The ability to quantify as well as qualify the cost benefit of ergonomic improvement initiatives is a critical skill that will differentiate those ergonomists who are viewed as being a source of value to the bottom line from those who are viewed as a corporate irritant.

In the past, many safety and health professionals were hesitant to use cost benefit analysis because it was ethically and morally challenging to place a value on the life and health of an individual. Ergonomics is a science that is based on both documented scientific research and sound engineering principles. Ergonomics is far more than a specialty within the safety and health field. It is a set of design principles that, when applied to the workplace, can create jobs that are within human capabilities and limitations.

The practical application of the science of ergonomics in the vast majority of situations has the potential to maximize the contribution of the worker to the work process, without compromising safety and health. We cannot forget that despite the advances in technology and automation, the single greatest resource available to most organizations is the human resource. Ergonomics can increase productivity and human performance by making jobs more physically and psychologically efficient as well as reducing the risk factors that can and often do result in lost work time and turnover. It is therefore very appropriate to use cost benefit analysis techniques to document the costs of ergonomic initiatives and quantify the benefits to safety and health as well as company productivity and profitability.

Many of us in the ergonomics community intuitively know that the benefits of most ergonomic improvements far outweigh the human and capital costs. Why, then, is it so difficult to sell ergonomics to management?

9.1 Why Do Organizations Feel They Need Ergonomics?

Why do companies today get interested in ergonomics? Typically, we have found from our consulting work with many clients that the driving factors are (in order of perceived importance):

- Money — specifically the money associated with ergonomically related workers' compensation losses
- Employee complaints
- Regulatory concerns — primarily OSHA citation potential under the General Duty clause of 29CFR 1910 or in anticipation of an OSHA ergonomics standard
- Productivity/Quality concerns

Money

Escalating workers' compensation insurance costs, lost workdays, absenteeism, and turnover all represent direct costs to the organization's bottom line. Reducing these costs is typically a top concern among CFOs, human resource managers, and risk managers.

Employee Complaints

Based on feedback from our customers, many indicated that they had started ergonomic initiatives because of employee complaints. The human body is a wonderful barometer of workplace physical and mental stress. Employees have become increasingly educated through the media, unions, and corporate communication policies to know that if their bodies are experiencing pain during the course of work,

that there may be a compensable causal relationship present. For management to ignore these complaints in the hopes that they will go away is simply naive in today's world. Addressing the complaints in a proactive, compassionate, and constructive manner has a definite, positive impact on employee relations.

Regulatory Concerns

A proposed OSHA ergonomics standard has been talked about for the past two administrations. Regulatory pressure has sent many employers the message, "Begin addressing ergonomic issues before the compliance officer shows up at the front door with the new standard in hand." Although a common consulting practice is to use the threat of regulatory penalties to drive behavior, we have found that such an approach typically also fosters a minimalist attitude. Management often loses sight of the fact that any standard is a "minimum standard" and, although it may produce some improved results, it generally will not achieve maximum results. Using the regulatory stick is not the best way to convince management of the cost benefit of ergonomics. Driving management to care about ergonomics through fear often results in programs that are not truly functional or integrated into the business operations.

Production/Quality Concerns

Some companies initiate ergonomics programs for productivity and quality reasons. These organizations typically end up with an ergonomics process that is truly integrated into the day-to-day business operations. Organizations that realize the most benefits from ergonomics will be those who drive the responsibility for successful program implementation to line management, where it truly belongs.

9.2 What Are the Costs Associated with Ergonomic Mismatches?

Workers' Compensation Claim Costs

Job related injuries and illnesses can result in either the filing of workers' compensation (WC) claims or employees and employers seeking redress through the group health insurance program if there is not a clear causal link to the workplace. When there is work-relatedness, the claim is typically filed through the workers' compensation program. For any claim there are associated direct and indirect costs, often referred to as "insured" and "noninsured" costs respectively.

Direct Claim Costs

Workers' compensation claim expenses may include immediate and long-term medical expenses resulting from the injury or illness, as well as payment of loss of income benefits if an employee is not able to work. In more serious cases, there may be payments for permanent or partial, full or temporary, disability. These costs may increase the WC premiums by increasing the experience modification factor. The experience modification factor is calculated and used by insurance carriers to determine a company's premium based on its own prior 3 years of loss experience. The rising costs of workers' compensation insurance are often one of the driving forces behind an employer's desire to implement safety and health program improvements.

Indirect Claim Costs

Indirect costs are not covered by WC insurance. Instead, they come directly off the bottom line profit of the organization. Although real costs have a significant impact on profits and expenses, they are hard to systematically capture and quantify and are therefore frequently ignored. Examples of indirect costs include:

- Time lost by personnel who were not injured but may be called in to assist the injured employee seek medical treatment or investigate the occurrence
- Cost of damaged material that resulted from the accident
- Cost of lower productivity while replacement workers learn new job skills
- Costs to make up lost productivity through increased overtime

Although direct and indirect costs may be used by safety and health professionals to justify an ergonomic initiative, these variables are widely misused and misunderstood. A better understanding of these expense variables, coupled with the expertise to include them in the preparation of a business case, can help the ergonomist build personal credibility in the financial ranks of the organization.

Measuring Claim Cost

A dollar spent today on a workers' compensation claim will buy more treatment than a dollar spent two years in the future on that same claim. For claims with minor medical expenses and only a few days of lost time, the claim expenses are largely known. Generally once a claim is closed, no additional expenses can be added to the file, assuming the file was closed properly. In more difficult cases such as those associated with cumulative trauma disorders, the claim file is usually open longer, due to the length of disability and the more complex nature of the medical treatment. In these cases, the longer the case is open, the more likely significant expenses will be incurred. In the insurance industry it is said that the longer the claim is active, the longer the "tail" it has, "tail" referring to the billing tail.

To accurately assign value to the "ultimate" expense associated with a workers' compensation claim, we need to take expense growth into account. Some claims may close quickly with all "incurred" expenses paid out. For others, expenses may continue to be billed for many years. In a recent consulting project, a review of a client's open claims found one "open" broken toe case from 1957 which had resulted in multiple failed surgical attempts at correction. Needless to say, the 40-year "tail" on this claim was far too long.

The Concept of Fully Developed Losses

Because ergonomically related injuries and illnesses tend to have long claim tails, the ergonomist needs to carefully compute the costs associated with these claims. For instance, suppose we analyze WC expenses for 1991, 1992, 1993, 1994, and 1995, as of some date in 1996 to make a business case for an ergonomic improvement program. It would be erroneous to assume that the total expenses that were incurred (as of our 1996 analysis date) were the ultimate costs of ergonomic losses, particularly if there were any cases still open in those time periods. Claims filed in any of those years may continue to incur expenses for years to come. Therefore, we must review claims from a specific policy year at a common point in time when performing any trending or development analysis. For example, to better estimate what the ultimate expenses might be for these claims, we would want to review them as of one year from the end of the policy period; 1991 claims as of 12/31/1992, 1992 claims as of 12/31/93, 1993 claims as of 12/31/94, and so on. Using this valuation method we would have a more meaningful estimate of what an appropriate trending factor for more recent claims with only a 12-month period of development.

Projecting what the ultimate loss cost could be for the open claims when they are fully developed in the future is what insurance actuaries do. They determine what the appropriate loss development factor is for a given situation. Actual development factors are very complex to compute and are dependent on many variables such as the mix of accident types, the state workers' compensation laws where the losses occurred, and the cost of medical treatment in that region. It is best to have the workers' compensation carrier provide this information to the corporate ergonomist for his or her use in performing a cost benefit analysis.

TABLE 9.1 Estimated Development Factors Example — ABC Company

Number of Months From Injury Period	Estimated Development Factor
12	3
24	2.4
36	2
48	1.7
60	1.5
72	1.4

TABLE 9.2 Total Incurred Loss Development Triangle Data as of 12/31/96 — ABC

Injury Period	Incurred Costs Months After End of Injury Period					Projected* Developed Loss Costs
	12 months	24 months	36 months	48 months	60 months	
01/01/91to12/31/91	\$208,479	\$491,458	\$486,729	\$610,929	\$644,170	\$625,437
01/01/92to12/31/92	\$372,350	\$696,184	\$771,243	\$898,899		\$1,117,050
01/01/93to12/31/93	\$341,006	\$495,115	\$611,806			\$1,023,018
01/01/94to12/31/94	\$212,734	\$331,337				\$638,202
01/01/95to12/31/95	\$255,169					\$765,507

* Note: the above projected developed loss costs were calculated using the costs incurred 12 months after the injury period (column 2 of Table 9.2) multiplied by the corresponding 12 month estimated development factor (column 2 from Table 9.1).

Table 9.1 is an example of estimated development factors that were used to project what the fully developed losses for a given injury period would be when all the claims are closed. These factors are gross estimates.

While this approach will work on workers’ compensation claims, the ergonomist should not forget that some ergonomically related claims may be reported through the group health system. Actuarial development of loss factors may not be applied on the group benefit side of the house or if it is, it may be harder to obtain those development factors from the group insurance carrier, particularly where employers offer flexible options to a host of competing health care providers and health maintenance organizations.

Table 9.2 illustrates the importance of using fully developed losses to assist in financial justifications. These data represent actual incurred dollars of a manufacturing organization with approximately 1000 employees.

Using the data in Table 9.2, one can clearly see that if the ergonomics consultant does not use estimated, fully developed loss costs, he/she can greatly underestimate the actual anticipated costs of the losses to the organization. If the ergonomist were to simply query the WC data for all incurred expenses for 1991–1995 as of 12/31/96, he/she would get the sum of the diagonal values in Table 9.2 to get a value of \$2,741,381. The earlier years have matured and have values closer to what their expected ultimate should be. The younger accident periods are considered “green” or not near ultimate. When development factors are applied to the data, the expected cost of the losses at ultimate is estimated at \$4,169,214. By not considering the development of the more recent injury periods the total expected cost was underestimated by \$1,427,833, or nearly 35%!

Salary Continuation Expenses (LTD/STD)

For those injuries and illnesses where workers’ compensation income benefits (in most states this is generally a statutory maximum benefit of 2/3 of the average weekly wage up to a predetermined ceiling) have been paid, it is important to remember to take into account the statutory waiting period and the

retroactive period for income benefit payment. These periods, which vary by state, can affect salary continuation payments through employer long-term disability (LTD) or short-term disability (STD) programs under group insurance. A few examples may be helpful to illustrate this consideration.

Connecticut has a 3-day waiting period before an injured employee is eligible to receive income benefit payments and a retroactive period of 7 days. The first 3 days of the absence which is work related are not paid under workers' compensation but may be covered by other means such as sick time or short-term disability (STD). On the 4th through 6th days the employee would be eligible for WC benefit payments for those 3 days only. If the employee is out 7 days, then all lost time WC income benefits going back to the original date of injury are covered under WC.

Florida has a waiting period of 7 days and a retroactive period of 21 days. For all WC claims with a duration of less than the retroactive period (21 days), the first 7 days of the absence are not eligible for income benefits under WC although they may be compensable under some other plan such as sick time or STD. Again, on the 8th day through the 20th day, the employee would be paid WC wage loss benefits only for those 13 days. Once the claim has a duration greater than 21 days, all lost time after the original date of injury is covered under WC.

Using WC indemnity or income benefit payments as the sole means to quantify expenses associated with a WC case can result in underestimating the total cost to the organization. In the Florida example, for every WC claim with a duration of less than 21 days, WC income benefit is paid for a maximum of 14 days. The remaining 7 days are not covered by the WC insurance but may be paid by other group or benefit funds of the employer. This "group benefit" can become substantial when considering injuries involving permanent partial disability and if the employer does not return the employee to work.

Some companies pay their employees full salary while they are out of work recuperating. In such a case WC payment from the WC insurer may be used to pay back the group policy. For example, if the worker is paid in full out of the group STD plan, the carrier will pay back the group plan the statutory amount (66% in most states) of lost wages. The remaining 34% will be incurred by the group plan. Depending on the employer's STD plan, this could continue up to 26 weeks.

Insurance industry studies have consistently shown a direct correlation on claim costs between the date a claim occurs and the date it is actually reported to the carrier. Industry studies have shown that the longer the lag time in claim reporting, the higher the costs of settling those claims, due to the lapse in time in establishing and monitoring appropriate medical treatment. Most ergonomists know that the sooner a worker reports job discomfort from repetitive motion tasks, the greater the chance of treating the job symptoms through early ergonomic intervention rather than waiting until the repeated trauma manifests itself into a more chronic case of RSI.

With a thorough understanding of the impact of ergonomically related injuries and illnesses on group disability and workers' compensation programs, the ergonomist can be proactive and work with the risk manager to establish policies which minimize the financial impact of the state WC statute on the company. These revised policies can be a significant benefit to the ergonomics effort in the areas of injury management and return to work.

Lost Workdays/Restricted Workdays

Production suffers when employees are injured and either away from the job or in a restricted duty capacity. For example, an employee working 40 hours/week with two weeks vacation has a maximum "full potential" for productive work of around 2000 hours/year. Subtracting from this full productive potential time items such as vacation, paid holidays and other paid leave days, nonwork-related illnesses, short- and long-term disability (either group or workers' compensation), continuing education days, and other planned absences, we find a realistic available productive time of closer to 1500 to 1700 hours productive time/employee/year.

To determine the actual amount of time it takes to make up for 100 hours of lost productive time, the following formula can be used ($100 \text{ h} \div \text{realistic productive hrs}/\text{maximum potential hours}$). Using the example of 1700 realistic productive hours and 2000 maximum potential hours, a loss of 100 hours would

require the company to recoup nearly 118 hours to get back the productivity lost due to the injury. Many loss analyses and cost benefit analyses do not take this fact into consideration. Therefore, they underestimate the actual costs of an injury or illness. The burden rate for the employees in the form of benefits, paid leave and vacation, corporate overhead, taxes, and pension contributions must be considered as well.

The Cost of Turnover

Ergonomic interventions can impact employee turnover rates. Little, if any, empirical research data are available on average rates of turnover by industry types due solely to ergonomic issues. However, we have found that human resources managers can frequently relate higher than normal turnover rates to those “tough jobs” which are physically demanding and/or involve a considerable amount of repetitive, labor-intensive work. We have worked with clients who have experienced high turnover rates in particular departments because of recurring back injury and repetitive strain problems. Injured employees may not “turnover” in the sense that they leave the company, but they may have moved on to other jobs within the same company that are less physically demanding or that could accommodate the physical restrictions resulting from their injuries.

It is important that a company capture the relationship between ergonomic issues and employee turnover. Where a positive correlation is identifiable, ergonomic cost/benefit analysis must consider the cost impact of ergonomic-related turnover. Typically, those costs include higher recruitment costs (advertising, interviewing, processing of new employees), higher training costs (basic orientation and job-specific skills training), lower productivity costs (as the new worker progresses up the learning curve), and higher costs due to quality problems, rework, scrap, and equipment misuse. Costs may be less if the turnover can be filled with internal candidates. Quantification of turnover costs is possible over time provided that there are tracking mechanisms in place to measure these costs. Employers may be able to identify ergonomic-related turnover during exit interviews.

Estimating the Probability and Value of Loss

A continual struggle for ergonomists and safety professionals alike is estimating the value of losses that might have occurred had effective loss prevention efforts not been in place. This intangible benefit — less risk of injury — can however be estimated when credible loss data exist from recent history for the organization. With good loss data the ergonomist should be able to determine the frequency of different types of ergonomic losses on a calendar or policy year basis for at least the last 5 years. The values of those fully developed losses (direct claim costs) should be known. If ergonomic-related claims are still open they should be projected to ultimate value. An illustration is helpful. One client put together a table (see Table 9.3). Using historical loss data for a prior 10-year period, it was possible to determine the frequency and probability of a \$60,000 back injury occurring (1 in 10 chance per year). By stratifying back injury statistics by severity (i.e., \$0–\$10,000, \$10,001–\$20,000, \$20,001–\$40,000, and over \$40,000) and frequency in prior years, the probability factors were determined. For example, if you were looking at the 1994 calendar year, the data would appear as in Table 9.3.

TABLE 9.3 Estimated Probability of Occurrence of Different Valued Claims

Type of Injury	Claim Value	Est. Indirect Cost	Total Claim Value	Claim Severity Range	Probability of Occurrence
Back injury — 1/5/94	\$45,675	\$15,000	\$60,675	over \$40,000	1:10
Back injury — 6/3/94	\$15,270	\$4,000	\$19,270	\$10,001–\$20,000	1:5
Back injury — 7/20/94	\$6,508	\$2,200	\$8,708	\$0–\$10,000	1:2
Back injury — 9/15/94	\$27,300	\$10,400	\$37,700	\$20,001–\$40,000	1:7
Back injury — 11/12/94	\$19,450	\$8,000	\$27,450	\$20,001–\$40,000	1:7
Total	\$114,203	\$41,600	\$155,803		
Average Value	\$22,840	\$8,320	\$31,160		

TABLE 9.4 Extrapolation to Predict Future Loss Information

Year	Clinic Visits	Doctor Cases	LWD Cases
1990	5	2	1
1991	6	2	2
1992	8	1	2
1993	6	3	1
1994	7	2	1
Total	32	10	7
Expected	6	2	1

From this type of information you could then make a more reasonable estimate of the benefit of preventing “X” number of back injury claims as a result of a specific ergonomic intervention.

In 1995, David Alexander² proposed an additional method for predicting future injuries based on historical claim data. He suggested that simple extrapolation of the frequencies of injuries can help establish a likely level of injuries for the upcoming year. Table 9.4 illustrates his concept.

9.3 Methods for Justifying Ergonomic Interventions

In addition to loss analysis skills and having an understanding of true loss costs, ergonomists still need to have a basic understanding of traditional accounting methods for determining cost benefit. While a detailed understanding of these accounting methods would certainly be beneficial, generally that type of expertise already resides in the accounting departments in many organizations. The corporate ergonomist should be interested in forming relationships with the true accounting professionals in their organizations, to assist him or her in developing a fiscally sound approach to cost benefit analysis. Ergonomists will still need to address the nonfiscal, less quantifiable, value-based benefits in most cases, but at least they will be starting from a sound accounting base.

What Is a Cost Benefit Analysis?

In his text book, *Essentials of Engineering Economics*, James L. Riggs³ identifies the origin of benefit analysis back to 1844. He also outlines the use of this economics tool in the U.S. and refers to the Rivers and Harbors Act of 1902, and the Flood Control Act of 1936. This benefit analysis technique required the Army Corps of Engineers to compare the expected results of alternative solutions. From these early uses of economic benefit analysis, two traditional types of benefit analysis are illustrated by Professor Riggs. The first, cost benefit analysis, evaluates all of the costs of the alternatives for the same project against the expected benefits, and the second, cost effectiveness analysis, compares the costs of various methods to reach a common business goal where the return may or may not have been determined.

Ossler⁴ in 1984 outlined the eight steps performed to conduct a cost benefit analysis. These steps can be a framework to approach ergonomic justification and cost benefit analysis (see Table 9.5).

TABLE 9.5 Ossler’s Eight Steps of Cost Benefit Analysis

Steps Performed in Cost Benefit and Cost Effectiveness Analysis	
Step I	Identify the stimulus or problem for conducting the economic analysis.
Step II	Specify the objectives or goals to be achieved by the program under study.
Step III	Determine the alternative means of attaining those objectives or goals.
Step IV	Enumerate the costs and benefits or effects of each alternative.
Step V	Assign monetary values to the costs and benefits or assign units of effectiveness.
Step VI	Perform discounting.
Step VII	Calculate the cost benefit or cost effectiveness ratio.
Step VIII	Compare these ratios by use of a decision matrix and feed this information into the decision-making process.

In addition to the traditional cost benefit analysis, there are some additional economic methods that may be used to justify ergonomic initiatives. They include: the payback method, present-value method, and the internal rate of return method. Details on these methods can be found in many accounting and management texts. A brief review of each method follows.

Payback Method

In the payback method the number of years required to recover the cash outlay of an ergonomic improvement, such as purchasing adjustable workstations for data entry operators, would be weighed against some predetermined cutoff point or date that management has considered to be acceptable.⁵ For example, in one organization a payback period of 5 years may be the norm against which decisions on capital and labor-intensive projects are based. In another organization that is more focused on short-term results, the acceptable payback period may be considered 3 years. Determining what are acceptable payback periods may represent one of the “values” of the organization, i.e., “If we are going to invest in a project, we want a quick payback.”

Internal Rate of Return

One of the most commonly used methods for rating and evaluating potential improvement projects is the internal rate of return. This method uses a discounted cash flow that ranks competing projects against each other. The internal rate of return is defined as the discount rate that renders the net present value of a stream of cash flows equal to zero.

Present-Value Method

The present-value method is a discounted cash flow method that considers the decreasing time value of any monetary investment. It is based on the assumption that a dollar today has greater value than a dollar at some point in the future. The net present value of a proposed ergonomic improvement would be determined by discounting future cash flows by appropriate factors and then algebraically adding all the discounted flow. The result is that the cost benefit ratio equals the net present value of the inflows divided by the net present value of the outflows. If this ratio is greater than one, generally the project would be considered acceptable.

Ergonomics and Productivity

Many ergonomic practitioners attempt to sell ergonomics using primarily injury loss data. This is an economically and socially *post facto* “reactive” approach which seems to overlook the fact that ergonomics and human factors have their roots in human performance. Enhanced performance improves productivity, and ultimately has an economic impact on operating costs and financial earnings. As an industry and a science, we must stress the simple truth that ergonomics assists the human machine to perform work more efficiently, within human capabilities and limitations. It is critical that we not lose our ability to justify ergonomic interventions on the basis of performance and productivity. Otherwise, how will we assist employers who have few or no workers’ compensation losses to build a preventive, proactive, ergonomics management system? Waiting until employees are hurt or injured is like waiting to perform maintenance on a valuable piece of equipment until it breaks. To reduce “human scrap” and maximize results we must intervene earlier in the process to maximize results.

Oxenburgh⁶ in his book uses a model to quantify those productivity costs related to safety and health. His model is a very thorough process by which the financial impact of safety-related losses (direct and indirect) can be shown to affect the overall productivity of an organization. Framing your ergonomic argument in terms of actual productivity data will open many doors and may help you convince skeptical managers about the true value of ergonomics and safety and health strategies. The following is a broad overview of the stages of Oxenburgh’s model:

1. Calculate the productive hours worked and paid for by the employer
2. Calculate the wage or salary costs
3. Calculate employee turnover and training costs
4. Calculate productivity shortfall due to absences
5. Determine total costs for employment and productivity shortfall
6. Estimate health, safety, and productivity benefits
7. Calculate cost of improvements
8. Determine payback period

As we will mention in the next section of this chapter, decisions made in any organization are strongly influenced by the company values and culture. If you find yourself working in an organization where the culture is production oriented then Oxenburgh's model can prove very beneficial. Many of the variables used to calculate the effective wage costs, as compared to the nominal wage of the employee, may not appear to be readily available. Additional digging is often required. If actual figures are not available the model is very flexible if assumptions or estimates have to be used. Dr. Oxenburgh goes a long way to prove his thesis that, "good health and safety practices are good for business."

Depending on the audience to whom the cost benefit analysis is being presented, each of the above models will have more or less value to them. For example, a department manager will generally place more value on the payback period, breakeven analysis, or return on investment. They are normally not accountable for the time value of money, but they are accountable for annual budgets and short-term results. At the corporate treasury and finance level, there would be more interest in the present value or internal rate of return methods because of their concern for cash flows and the cost of borrowing money.

9.4 The Influence of Corporate Culture on Cost Benefit Analysis

The influence of an organization's inherent culture or personality will greatly affect how the cost benefit analysis financial tool can or should be used. "Costs and benefits can only be defined in the context of each organization's unique culture." Can this statement be true? Clearly one could successfully argue that the simple direct costs of repetitive strain injuries, back injuries, and other "ergonomically related" injuries are not culturally dependent. While this is most likely true, the culture comes into the cost benefit analysis consideration when other soft and hidden costs and benefits are likely to be perceived by management as credible and value adding. Because of this it is important to view the total set of costs and benefits as closely related to what the organizational value system is. The quantification of costs and benefits is especially sensitive to those organizational values. It becomes especially important when the costs and benefits are less tangible and often indirect.

The concept of "value-focused thinking"⁷ has been presented in the literature as a different way to approach decision making. When faced with making a decision, such as "should we conduct this ergonomic intervention in the workplace to reduce cumulative trauma injuries?" the traditional approach is to consider the problem from the perspective of the alternatives and then considering objectives or criteria to evaluate each alternative (cost/benefit ratio). With value-focused thinking, the values that are important to the organization become the principal measure against which alternatives and their consequences are evaluated. Ralph L. Keeney, professor of systems management at the University of Southern California, states in his article, "It is these values that are fundamentally important in any decision situation, more fundamental than alternatives, and they should be the driving force for our decision making. Alternatives are relevant only because they are means to achieve values."⁷

Organizational Culture and Values

Culture is defined as the set of key values, guiding beliefs and understandings that are shared by most members of an organization. The culture defines the basic organizational values. It helps to communicate

to new members the “correct” way to think and act, and how to get things done — “the unwritten rulebook.” Culture represents the feeling part of the organization and provides members with a sense of identity. When the culture is shared and accepted by the members of the organization, it generates a commitment to support the beliefs and values that are essential to sustain the performance of the group. It should be noted that “performance” may range from poor to outstanding.

Organizational values are the underlying beliefs or philosophies of the organization. The values of the organization are the core of the culture and influence decision making. Some authors describe values as:

- “The shared ideals, either explicit or implicit, that guide the organizational choice and behavior.”⁸
- “The basic concepts and beliefs of an organization, such that they form the heart of the corporate culture. Values define success in terms for employees — ‘If you do this you too will be a success’ — and establish standards of achievement within the organization.”⁹
- “Shared values. What the company stands for — stated and implied, good and bad. What a company is proud of or would like to be proud of.”¹⁰

Tom Peters and Bob Waterman stated that their “one all purpose bit of advice for management” was to “figure out your value system” as they pursued excellence.¹¹ Those companies with excellent management have one thing in common: a shared understanding of what their organizational value system is and what their companies stand for. Values influence individual behavior and decision making. They can shape how management will define those variables that they are willing to use for an ergonomic cost benefit analysis. To understand how to quantify costs and benefits, the ergonomist must first determine the variables and values that the organization considers credible and will allow in the calculation. The so-called soft costs or savings, although recognized as real, may not be allowed by some organizations in the cost benefit analysis.

Performance-related values define the orientation of the organization toward issues involving finance, productivity, quality, and health, and safety. Organizations that do not have a balanced set of values that place the well-being of their employees on the same level as the fiscal values for increasing stockholder wealth and productivity will create a value of conflict when considering ergonomic benefits to the organizations. It is crucial that the corporate ergonomist or consultant determine the value set of the organization prior to making his or her business case for the recommended improvements. One way to determine that value set is to look at examples of other business cases that were successfully presented to and accepted by management. A business case that does not mention safety and health or quality may be an indication that you are dealing with a very fiscally based value system. Knowing this you would want to build your business case primarily on those hard, direct tangible benefits that might be expected from the ergonomics intervention.

Demonstrating and Communicating Safety and Health Values

The existence of shared safety and health values and norms that clearly indicate the importance of safety as a function of good business is essential. These values must be clear so employees will understand what choices to make if conflicts between safety and other business priorities arise. The following are benchmark values that are common among companies with excellent safety records.

- Nearly all work-related injuries and illnesses are preventable.
- Management is responsible for creating a safe work environment.
- All employees are accountable for following established safety procedures.
- All workplace safety and health exposures can be controlled.
- Safety training is essential
- Safety is an integral part of the business plan

Many U.S. corporations do not have documented statements that communicate their corporate values, let alone their safety and health values. Lacking these statements people create their own perceptions or

interpretations of what they think the safety values of the company are. For example, faced with making a decision to get help, use a mechanical lifting aid, just say that the object is too heavy to lift, or take a chance that he can handle the lift alone, a worker may choose the latter based on the perception that speed takes precedence over safety. He or she may suffer a serious back injury as a result of this decision. When questioned, management would likely state that they do not tell people to place themselves at risk to save a few minutes. However, the reality is that risk-taking behavior has been condoned (although maybe indirectly by the lack of verbal or visible management action when risk-taking behavior has been observed in the past) while getting the job done quickly has been rewarded. Therefore, speed over safety has become a value that is supported in the organization and in the minds of the employees.

Advances in Economic Analysis

Professors John K. Shank and Vijay Govindarajan¹² present a case for a new method of looking at the benefit of technological investments, which they call “Strategic Cost Analysis.” “A project-level net present value (NPV) framework, it is argued, places such a premium on short-term financial results, and so little emphasis on difficult-to-quantify issues, such as quality enhancement or manufacturing flexibility, that major manufacturing breakthroughs do not pass the NPV test.”¹³ The Strategic Cost Analysis (SCM) perspective may have more widespread applicability to the issues facing corporate ergonomists in trying to quantify the benefits of ergonomic interventions and improvements. SCM is a blend of three approaches to cost analysis:

- Value chain analysis
- Cost driver analysis
- Competitive advantage analysis

Value Chain Analysis

Value chain analysis is a more holistic approach that would take into consideration the impact of the ergonomic improvement throughout the value chain of its goods and services. Rather than asking what value would be added in this department or this job by the intervention, value chain analysis would ask what impact will this change have on the consumers of the goods and services, on the company’s suppliers, on other employees in different departments, and on the rest of the organization.

Cost Driver Analysis

Cost driver analysis looks at what Shank and Govindarajan refer to as “structural drivers” and “executional drivers.” Structural drivers are a function of the:

- Scope of the ergonomic improvement (one workstation or one thousand workstation upgrades)
- Complexity of the new technology that may be employed (redesign of an automated material handling system)
- Other factors such as experience of the designers and installers

On the other hand, executional drivers would force organizations to look at issues such as how will this strategy be implemented in a TQM or traditional business environment, how can employee and management participation and acceptance be enhanced, and are the necessary resources to execute the strategy effectively available and committed?

Competitive Advantage Analysis

Finally, the competitive advantage analysis would address the issues of whether the ergonomic improvement will enhance the ability of the organization to compete based on cost or some other means of

market differentiation. The retention of skilled employees is a clear example of how an ergonomic intervention can give the organization a competitive advantage over another employer that experiences a high rate of turnover and lost time within its workforce of knowledge workers due to ergonomically related injuries. The employer that reduces ergonomic risk will experience less new hire training expense and will have a larger percentage of skilled, experienced employees in the workforce.

Summary of Costs and Benefits

Regardless of whether a simple cost benefit method or combined value/cost based approach is used to sell the need for an ergonomics intervention, the ergonomist must be capable of communicating objectively and clearly to management about the anticipated costs and benefits of their proposal. The following table is a summary matrix of some of the cost drivers and benefits. These are easily quantifiable and typically associated with an ergonomics intervention, and therefore, should be considered in the cost benefit discussion.

TABLE 9.6 Summary of Potential Cost Benefit Variables

Potential Cost Variables	Actual Costs	Potential Benefit Variable	Actual Benefits
Employee training		Reduced injury costs (medical, claim, expense)	
Outside consultant fees		Increased potential for reduced WC experience modifier	
Capital equipment purchases		Reduction in nonvalue added material handling tasks	
Facilities design changes		Improved job cycle time	
Procedural changes cost		Improved productivity by hourly workers	
New equipment installation costs		Improved productivity by administrative workers	
Future equipment maint. costs		Reduced scrap rates	
Other costs:		Improved product and service quality	
		Reduced employee turnover	
		Reduced training costs resulting from accidents	
		Reduction in overtime charges to replace injured worker production	
		Reduced potential for regulatory fines and related productivity loss	
		Improved employee morale	
		Enhanced customer service capability	
		Enhanced product and service differentiation potential	

Summary and Conclusion

In today’s globally and locally competitive marketplace it is natural and logical that senior management will ask the question “What’s in it for us?” when faced with a request to commit resources to ergonomic improvements. Traditional methods of defining cost benefit in terms of expected return on investment in the shortest possible time period are still important principles that the ergonomist should know about.

The ability to understand and effectively communicate the financial ramifications of ergonomically related workers’ compensation losses or losses that are put in against a company’s group insurance program are critical skills that the corporate ergonomist must have. As insurance programs and risk financing methods become more complex, being able to talk one on one with risk managers and financial

managers about direct and indirect costs that they understand will go a long way toward securing buy-in for ergonomic interventions.

A new twist to the cost benefit puzzle that needs to be explored and incorporated in more benefit presentations is the “values based” approach. Whether we like to admit it or not, corporate values have a very powerful influence on what gets done or does not get done in organizations. Without a clear understanding of what those internal value systems are, both organizationally as well as individually, the ergonomist may find himself or herself with what appears to be a fiscally sound intervention proposal that goes nowhere. The ability to appeal to values when the more traditional approaches to salesmanship have failed is what will differentiate the ergonomist of the future.

9.5 Justifying Ergonomics Initiatives — Case Studies

Travelers Tennessee Nursing Home Study¹⁴

This project was undertaken with six nursing homes in Tennessee. They were purchasing their workers’ compensation insurance through the assigned risk plan because of previous high injury rates and elevated workers’ compensation experience modification factors. Back injuries among nurses and nurses aides were the major cost drivers behind the experience rating. The project focused on three areas of concern:

- Resident patient transfer methods
- Resident transfer lifting and patient handling equipment issues
- Medical management of injured workers

In their study the authors reported that “one of the major stumbling blocks to implementation of mechanical resident transfer equipment was the perception that equipment could not be justified. An example cost justification for mechanical resident transfer equipment is shown here. The justification is based on a five-year lease, assuming a yearly interest rate of 9%.”

Based on an initial estimate of four lifts in one of the nursing homes in the study, a five-year lease will cost approximately \$650 per month, based on equipment cost estimates and interest on the lease. The lease analysis assumes an average of the five-year injury cost history (\$5454/month) and a 15% minimum return. For the five-year lease period, assuming no escalation in workers’ compensation costs, the net present values of all costs and benefits are:

BENEFITS = \$154,616 (workers’ compensation back injury reduction)
 COSTS = \$25,430

To be conservative, 50% of the potential workers’ compensation back injury reduction benefit was used, $50\% \times \$154,616$, or \$77,308. The cost benefit ratio (CBR) for all the participants in this study is shown in Table 9.7.

Table 9.7 Cost Benefit Ratios for Project Participants

Facility Number	Cost Benefit Ratio
Facility 1	3.04
Facility 2	3.47
Facility 3	3.25
Facility 4	Data not available
Facility 5	2.10
Facility 6	0.5 *

* The losses for facility six did not justify equipment purchase based on the study’s assumptions.

Other benefits cited were:

- Certified Nurse's Aides (CNA)s should be able to safely transfer residents alone, where now two, three, or four are required. (**Benefits:** A reduction in manpower requirements. Better utilization of resources. Potential for improving quality of care to other residents with more availability of nursing staff. The time required to get help was also drastically reduced.)
- The concept of using three or four CNAs to move a resident could be eliminated. Even though using additional help may help in lessening the load, generally one or more of the CNAs get in each other's way. The biomechanical load is imposed unequally, usually on one or two of the CNAs. (**Benefits:** Reduced potential for back injury due to unequal biomechanical loading plus the other benefits cited above.)
- All of the nursing homes implemented all or part of the improvement strategy. The total injury incidence rates were reduced compared to the previous year's rates. Two of the six facilities were taken out of the Tennessee assigned risk pool and were able to return to the competitive insurance market for pricing quotes. (**Benefit:** Generally the competitive market results in lower premiums, thereby reducing operating expenses and improving cash flow.)
- Two other facilities have current experience modifiers of 0.85. This means that because they are approximately 15% better than the industry average, their workers' compensation insurance premium earns a 15% credit. (**Benefit:** Reduced operating expenses. Possibly translating into better allocation of funds to facilities and staff improvements that benefit the nursing home customers, i.e., more value-added services or reduction in charges resulting in more competitive market position.)
- Subsequent interviews with CNAs have suggested greater job satisfaction, as a great deal of the difficult portion of their job has been reduced due to implementation of mechanical lift equipment. (**Benefit:** Improved employee morale.)

Vehicle Subassembly Plant Ergonomics Success Story

This case study took place in a vehicle subassembly plant that essentially attached vehicle bodies to a preassembled chassis. Operation began early in 1987 and by November that year they hit the production level of 95 units per day. As the operation began to grow through 1989 so did the incidence of back injuries and cumulative trauma disorders.

Late that year the corporate parent company began a TQM initiative and started to identify work processes that had opportunities for improvement. In the 1st quarter of 1990 the lost time frequency rate at this location approached 19.4. Local management saw ergonomics as an area of importance and decided to address these issues using the corporate TQM approach. At that time they developed an ergonomics problem-solving team and allocated \$100,000 for ergonomic improvements.

Soon after team formation each member received 2.5 days of ergonomics training. The teams initially were focused on reactive problem solving using loss analysis as a guide to direct them to problem areas. Specific solutions at this stage included:

- Work tables
- Carts
- Platforms
- Floor mats

By June of 1990 the team began to use proactive techniques to address ergonomic issues by identifying problem tasks through observation of risk factors, conducting task analyses, and requesting employee feedback. Through this process the team determined that supervisory training was needed. A training plan to train all supervisors was created and implemented. At the end of 1990, another \$100,000 was allocated for ergonomic improvements.

TABLE 9.8 Cost Benefit Analysis (1989 to 1992 as of 1992 year end)

Loss Area	Ergonomic Expenditures	Total Savings	Return on Investment
All Injuries	\$300,000	\$657,618	119%
Back Injuries	\$160,000	\$349,315	118%

Early in 1991, ergonomics was considered to be a critical work process consideration and became part of the 1995 vision statement. After the supervisory training was conducted, supervisors were integrated into the teams and employee feedback was incorporated into the problem-solving efforts. At this time the ergonomics team had implemented many solutions including:

- Rivets squeezers
- Improved tooling and fixturing
- Ergonomic seating
- Powered pallet movers
- Hydraulic lift tables
- Overhead cranes and hoists
- Vacuum manipulators

The ergonomics process was now integrated into the business operation and the team began to measure and monitor results of the interventions. Administrative controls were considered in those tough areas where the engineering controls were not completely addressing the issues. In the paint department, for instance, a job rotation process was piloted and later implemented. In addition, a formal medical case management process was implemented which facilitated employee return to work and conservative medical treatment. Preliminary results indicated that the frequency rate had decreased to 9.57. A presentation was made to senior management with these results and another \$100,000 was allocated for the 1992 budget.

Through 1992 employee and supervisory training continued and more strides to involve employees in the process were made. Job rotation was embraced by management, and initial rotation strategies were expanded to include 85% of the production area. By the end of 1992 over 90% of all repetitive bending, twisting, and heavy lifting was eliminated. Lost time frequency continued to fall to a level of 5.89 and for the first quarter of 1993 reached the lowest level since the inception of the ergonomic efforts. Management was very pleased with these results and allocated an additional \$85,000 for the 1993 budget.

Measured Results (loss data collected on 12/31/92)

- Back injuries per year were reduced from 85 to 11
- Upper extremity CTDs per year were reduced from 105 to 54
- Lost workdays were reduced from 1,402 to 476
- Lost time frequency reduced from 19.39 to 4.4 (data as of 3/93; see Table 9.8)

Other Tangible and Intangible Benefits Which Were Cited but not Quantified

- Increased quality
- Increased productivity
- Decreased inventory levels
- Decreased scrap
- Decreased turnover/absenteeism
- Increased morale

Keys to Success

- Extremely strong senior management support
- Identified as a critical work process

- Senior management focused on performance of the ergonomics team, implementation was stressed
- Strong TQM culture facilitated problem solving
- Ergonomics team was multidisciplinary
- Ergonomics team was empowered to solve problems and given the resources to execute
- All employees and management received appropriate ergonomics training

Post-Injury Ergonomics Intervention for a Chronic Carpal Tunnel Case

Ergonomic interventions can be useful to facilitate the return to work of employees once an injury has occurred. This approach can be valuable for repetitive strain injuries to the upper extremities or to the back. Ergonomic interventions may also offer value to many of the traumatic injuries reported on the OSHA 200 log. Estimates indicate that up to 25% of the OSHA recordable injuries have root causes that are ergonomic related.

This case study illustrates the importance of return to work processes as part of an overall ergonomics program. Return to work efforts become more complex when the employee injury is cumulative in nature. In these cases it is essential that the employer not only provide the employee with exemplary medical care but identify and control those workplace factors that were likely causes of the injury. In return-to-work scenarios such as this, controlling the injured employee’s exposure to those job-related risk factors can be either engineering or administratively based.

This specific case involved an employee who was diagnosed with chronic carpal tunnel syndrome. The employee was a computer operator who performed keying up to 6 hours a day, 5 days a week. After a trial of conservative treatment, the employee’s symptoms persisted. Electrodiagnostic evaluation indicated that there was significant median nerve pathology, and surgical intervention was recommended. Post-surgical response was poor and the patient was later diagnosed with reflex sympathy dystrophy (RSD).

The employer was very cooperative with the employee up to the diagnosis of RSD. At that time the treating physician gave the employee permanent work restrictions that included a maximum of 1 hour of keying a day. It was felt that this restriction would continue as long as the employee had pain. At this time the employer made the decision to terminate the employee because they did not have any jobs that this employee was qualified to do with this keyboarding restriction. After the employee’s 26 weeks of short-term disability was completed, the termination process was initiated.

The employer’s insurance provider was informed of this decision and contacted management of the employer to discuss this case. The carrier felt this course of action would put the employer at legal risk and increase the eventual costs of this claim. The carrier carefully evaluated the financial impact of this decision and prepared the two scenarios that are diagrammed in Table 9.9 for the employer.

As can be seen from the data the employer would save up to \$255,294 if they accommodated the employee. In this case these figures helped convince the employer to consider providing the employee with alternative productive duty. In fact the employer did create a job for the employee that did not require extensive keying and that the employee was qualified to perform. At the time of this report, the

TABLE 9.9 Comparison of Two Approaches to a Chronic Workers’ Compensation Case

Type of Cost	Scenario 1 — Terminate Employee after 26 Weeks of STD	Scenario 2 — Accommodate the Employee	Saving Realized by Accommodating the Employee
Workers’ Compensation Expenses (Projected Medical and Indemnity)	\$86,125	\$48,711	\$37,414
Short-Term Disability Minus Any WC Offsets	\$6,932	\$5,532	\$1,400
Projected Long Term Disability	\$116,480	0	\$116,480
Potential Legal Exposure (ADA, Wrongful Termination, Retirement Settlements)	\$100,000	0	\$100,000
Total	\$309,537	\$54,243	\$255,294

employee was still experiencing pain from the CTS and RSD but remained gainfully employed and, most importantly happy to contribute to the employer where he/she had provided many years of loyal service prior to the injury.

References

1. Ford, Henry, Crowther, Samuel, 1922, *My Life and Work*, Garden City Publishing Co., Inc., Garden City, New York.
2. Alexander, David, C., 1995, *The Economics of Ergonomics: Part II*, Proceedings from the Human Factors and Ergonomics Society 39th Annual Meeting, Santa Monica, CA.
3. Riggs, J. L., 1982, *Essentials of Engineering Economics*, McGraw-Hill, New York,.
4. Ossler, C. C., 1984, *Cost Benefit and Cost Effectiveness Analysis in Occupational Health*, Occupational Health Nursing, January.
5. AMA Management Handbook, 2nd Edition, copyright 1983, AMACOM, New York, NY
6. Oxenburgh, M., 1991, *Increasing Productivity and Profit through Health and Safety*, CCH International, Chicago, IL.
7. Keeney, Ralph L., *Creativity in Decision Making with Value-Focused Thinking*, Sloan Management Review/Summer 1994.
8. Connor, Patrick E. and Lake, Linda K., 1988, *Managing Organizational Change*, Praeger Publishers, New York.
9. Deal, Terrance E., Kennedy, Allen A., 1982, *Corporate Cultures — The Rites and Rituals of Corporate Life*, Addison — Wesley Publishing Co., Reading, MA.
10. Waterman, Robert H. Jr., 1987, *The Renewal Factor*, Bantam Publications
11. Peters, T. and Waterman, R., 1988, *In Search of Excellence*, Warner Books.
12. Shank, John, Govindarajan, Vijay, *Strategic Cost Analysis of Technological Investments*, Sloan Management Review/Fall 1992, pp. 39-51.
13. Hayes and W. Abernathy, *Managing Our Way to Economic Decline*, Harvard Business Review, July-August 1980, pp. 66-77.
14. Wyatt, R.S. and Booth, C., *Reducing Employee Back Injuries in Skilled Nursing Facilities*, 1993 Internal Thesis, Travelers Indemnity Company.

Section II

Ergonomics Processes

10

Success Factors for Industrial Ergonomics Programs

10.1	Introduction	10-1
10.2	Discussion of Success Factors	10-2
	Emphasize Business Objectives • Avoid Too Many Low-Value/High-Cost Solutions • Ensure That Ergonomics Projects Are Evaluated Quantitatively • Maintain a Tabulation of the Cost of Projects • Use Resources Efficiently (the Self-Help/Skilled-Help/Expert-Help Strategy) • Identify and Overcome Barriers • Training Should Be Supported by Suitable Infrastructure • Avoid Using “Ergo-Babble” • Clearly Define the Purpose of Your Ergonomics Program • Plan the Stages of the Ergonomics Culture Change • Create a Strategic Plan • Understand the Difference between an Ergonomics Program and the Practice of Ergonomics • Create a Tactical Plan • Ensure That There Are Regular Quantitative Evaluations of the Overall Ergonomics Program • Do Not Wait for Top Management to Push the Program Down • Maintain Political Support	
10.3	Conclusion.....	10-13

David C. Alexander
Auburn Engineers, Inc.

Gary B. Orr
USDOL/OSHA

10.1 Introduction

Many ergonomics programs are not successful. A survey performed by Auburn Engineers (Auburn, Alabama) found that only 25% of the ergonomics programs they surveyed were successful. The data, shown in Figure 10.1, separate the organizations into small, medium, and large sizes. Four different outcomes are possible:

- Successful
- Too new to call
- Floundering due to management issues
- Floundering due to technical issues

The term floundering was chosen to indicate that more effort is going into the ergonomics program than is appropriate for the results being achieved. While this is not technically a failure, it is clearly headed in that direction. Floundering due to management issues was the result of lack of vision or program direction, inadequate resources, lack of coordination, and other management issues. Floundering due to technical issues included programs where there was a fundamental lack of technical skills such as job analysis or ability to generate appropriate solutions.

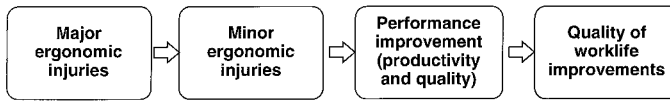

FIGURE 10.1 Progression of the results of ergonomics projects.

This chapter lists a number of success factors which will make an ergonomics program effective. It is not easy to develop a list such as this. After reviewing hundreds of programs, success factors and common flaws begin to appear. Many of these are found in this chapter. At the same time, a successful ergonomics program does not have to include all of these factors. Many, but not all, of these factors are found in successful programs.

The success factors can be roughly divided into four groups:

- Meet business needs
 1. Emphasize business objectives
 2. Avoid too many low-value/high-cost solutions
 3. Ensure that ergonomics projects are evaluated quantitatively
 4. Maintain a tabulation of the cost of projects
 5. Use resources efficiently (the self-help/skilled-help/expert-help strategy)
- Avoid common traps
 6. Identify and overcome barriers
 7. Training should be supported by suitable infrastructure
 8. Avoid using “ergo-babble”
- Create a strong purpose
 9. Clearly define the purpose of your ergonomics program
 10. Plan the stages of the ergonomics culture change
 11. Create a strategic plan
- Maintain the program
 12. Understand the difference between an ergonomics program and the practice of ergonomics
 13. Create a tactical plan
 14. Ensure that there are regular quantitative evaluations of the overall ergonomics program
 15. Do not wait for top management to push the program down
 16. Maintain political support

10.2 Discussion of Success Factors

Emphasize Business Objectives

For an ergonomics program to sustain itself over the long term, it must be anchored to business objectives. The best way to do this is to ensure that its results improve the business objectives of the organization. There is a progression in the types of results achieved, as shown in Figure 10.1. Most ergonomics applications are initially targeted toward the elimination of major injuries, and then minor injuries become important. Once injuries are under control, the emphasis should shift to improving performance in the areas of productivity and quality, and eventually, improvements in the quality of worklife should occur. A successful ergonomics program will, as soon as practical, ensure that business objectives are improved, documented, and shared with management.

This may be difficult to do because many ergonomists only see ergonomics as a technology and not as a business enhancement tool. In business, however, technology is a tool to achieve business objectives. Unfortunately, when ergonomics is applied primarily as a technology without firm business goals, the results rarely amount to more than training and scattered job analyses.

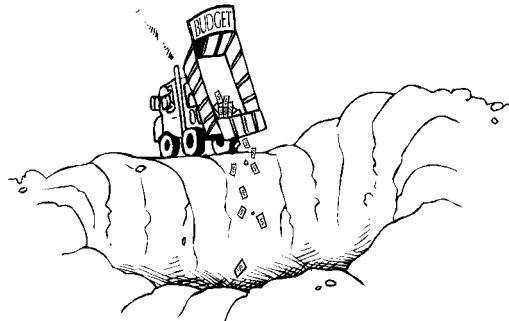

Management's View of Ergonomics

FIGURE 10.2 The money pit.

Fortunately, though, when ergonomics is viewed as a tool which helps drive important business measures, it continues to be important over an extended time period, and will be retained. However, when ergonomics is seen either as an “add-on” with little business value or as a “must do” from a compliance standpoint, an ergonomics program will only be mildly supported and eventually discontinued.

Avoid Too Many Low-Value/High-Cost Solutions

Cost is or soon becomes an issue for most ergonomics programs. When costs are too high relative to the value received, the ergonomics program is regarded as a money pit and is stopped or slowed down (see Figure 10.2).

Expensive solutions usually result from a misunderstanding of the role of people and equipment such as an “automation mentality” which requires that automation be used to remove the person totally from the job. In the office area, many office ergonomists go on a “chair buying binge” and spend too much on new seating with correcting the hand/wrist problems common in office areas.

Typically, these problems result from less experienced ergonomists who have difficulty creating low-cost solutions that address the root cause. Many ergonomists have developed skills to identify and analyze ergonomics problems. Unfortunately, if they have not developed skills for the efficient resolution of those problems, the result can easily be overly expensive solutions.

When the common solution for ergonomics problems is to “automate the job,” a single solution can be very costly, often in the range of \$100,000 to \$1,000,000. It is difficult to offset this high cost with the benefits gained, and this gives management the perception that ergonomics is (and always will be) prohibitively expensive. It does not take management long to tire of these types of “low-value/high-cost solutions.” And once that occurs, the ergonomics program usually has a short future.

An example can illustrate this concept. Suppose that a material handling problem has been uncovered, and the question is how to resolve it. A less experienced ergonomist might use automation, when other alternatives such as scissors-lifts, spring-loaded levelers, and turntables are available. Typically, an administrative control is also considered, and one might even add the consideration of back belts to the decision. For many lifting situations, simply getting the lift to correct height and close to the body will resolve the problem. The two-dimension matrix in Figure 10.3 easily shows where the value/cost benefit lies. Figure 10.4 provides a generic view of the value cost matrix and how to assess different solutions for their own value/cost relationship.

Ensure That Ergonomics Projects Are Evaluated Quantitatively

Only the most successful ergonomics programs have instituted a systematic method for quantitatively evaluating individual ergonomic projects. Ergonomic projects should be evaluated for both ergonomic improvement and for cost/benefits. The degree of ergonomic improvement can be measured by changes in such lagging indicators as incident rate, severity rate, or losses for workers' compensation. It is also

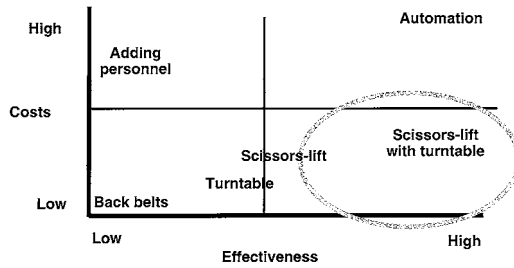

FIGURE 10.3 Possible solutions for a material handling problem.

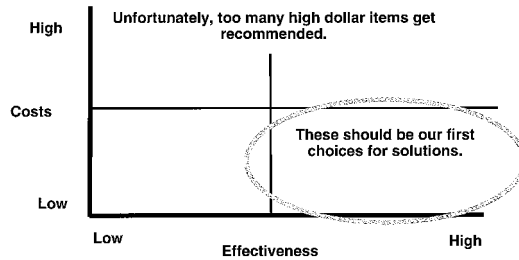

FIGURE 10.4 Avoid too many low-value/high-cost solutions.

possible to use leading indicators such as a symptoms survey or pain/discomfort body parts survey. It is best to use these surveys more than once, and a suitable timetable for surveys is based on “Dave’s Rule of Twos” — perform a survey after the changes have been implemented for two days, then again after two weeks, and finally, after two months.

In addition, each ergonomics project should also be evaluated financially. The costs and benefits can be measured for each project. These dollar figures for costs and benefits can be translated into net overall improvement for all the ergonomics projects, or a cost/benefit ratio for each project can be maintained. Each project does not have to pay off, but, overall, the program should be able to pay for itself.

These basic items can become part of composite measures such as those listed below:

- Cumulative stress reduction (CSR) index — Index of stress reduction \times number of people affected
- Cumulative stress reduction per \$1,000 — Ratio of CSR index to costs

One additional project evaluation measure which has created a lot of interest is the time to complete each project. Usually this is just the elapsed time from the day the ergonomic project is initiated until the recommended solution is implemented. If the ergonomic problem-solving skills are increasing, then the time to complete individual projects should be decreasing.

Maintain a Tabulation of the Cost of Projects

Cost is an important issue for many ergonomics programs and one additional method of cost measurement is valuable. Since so many projects are incorrectly assumed to be overly expensive, a simple tabulation of the costs of a number of projects can help dispel the notion that all projects must be costly. Table 10.1 shows the costs of 29 ergonomics projects completed by Auburn Engineers in late 1994 and early 1995. The interested reader will note that about half of these project solutions cost less than \$500 per project. Most of these projects (98%) cost less than \$5,000.

Tracking costs like this places an emphasis on the low-cost (yet effective) solutions, and it sends a clear and simple message to ergonomic problem solvers. The message is “solve the problem, but spend as little money as possible. If we save money on one project, then we have more left for additional projects.”

TABLE 10.1 Cost of Ergonomics Solutions

Cost per Project	Number of Projects	Cumulative % of All Projects
Less than \$100	11	22%
\$100 to \$500	12	47%
\$500 to \$1,000	11	69%
\$1,000 to \$2,000	7	84%
\$2,000 to \$5,000	7	98%
Over \$5,000	1	100%

TABLE 10.2 Efficiently Using Problem-Solving Skills

Skill Level	Self-Help Problems	Skilled-Help Problems	Expert-Help Problems
Occurrence	50–70% of problems	20–40% of problems	5–15% of problems
Typical problem	Simple and “Quick Fix” problems	Multiple workplace changes or complex diagnosis	Most complex problems, unique problem, complex multi-part solution, expensive solutions
Typical solution	Adjust workplace, proper pace, use proper tools, awareness of early warning symptoms	Workstation redesign, modification of production process, new assembly tools	Unique tool, design of entire factory, redesign of production process
Expertise	With minor training, can be resolved by many people	Requires training, practice and possible guidance	Requires special expertise or professional judgment
Typical training	2–4 hours of ergonomics awareness training	2–3 days of team-based ergonomics problem solving	Graduate degree plus professional experience

Use Resources Efficiently (the Self-Help/Skilled-Help/Expert-Help Strategy)

A successful ergonomics program will ensure that it uses resources as efficiently as possible. The major costs are personnel and hardware. Hardware costs were outlined above. Personnel costs can be controlled by delegating the ergonomics problems to the correct skill level. Too many ergonomists get involved in projects that do not require their level of skill, and which they should delegate to others.

Efficient problem solving uses a stratification based on the difficulty of problems using three levels called self-help problems, skilled-help problems, and expert-help problems. For most organizations, the number of self-help problems is the largest. Following is a list of the three types of problem-solving groups, a brief description of each type, and the training required:

- *Self Help.* Self help is the lowest cost method to resolve an ergonomic problem. Self help also requires the lowest level of problem-solving skill. Self-help solutions are usually generated by a worker along with his or her supervisor. Awareness training provides the workers with the necessary skills to determine the self-help solutions by familiarizing them with symptoms of musculoskeletal disorders, workplace risk factors, and ways to reduce risk factors.
- *Skilled Help.* This is the second lowest cost method of problem-solving help. Skilled help typically involves a problem-solving team comprised of workers who have had ergonomics problem-solving training. Awareness training is inadequate to perform at this level.
- *Expert Help.* Expert help is provided by an expert ergonomist, typically a corporate ergonomist or an outside ergonomics consultant. This is the most expensive level of help and should be utilized for problems that are too difficult to solve or go beyond the knowledge and skill of the other two help levels.

A summary is shown in Table 10.2.

TABLE 10.3 Four Typical Barriers

Barriers	Methods to Overcome Barrier
Not enough time	<ul style="list-style-type: none"> • Determine “Top Five” or “Dirty Dozen” problem areas • Avoid “paralysis by analysis” • Enable others and get them involved • Buy additional time
Too little money	<ul style="list-style-type: none"> • Use low-cost/high-value solutions • Use nickel and dime solutions • Avoid cost/benefit justification • Cluster projects • Get “refillable pot” of funds • Use two-step solutions
Gaps in skills	<ul style="list-style-type: none"> • Provide specific training (and only as needed) • Look for existing solutions (remember worker modified solutions) • Use teams for simple problems and experts for difficult problems
Management concerns	<ul style="list-style-type: none"> • Propose a specific plan • Answer the 5 questions managers ask • Develop an ergonomics culture • Understand change management

Identify and Overcome Barriers

Successful ergonomics programs identify and overcome barriers to their success. There are many barriers which occur with any new initiative, and to be successful, the barriers must be identified, resolved, and eliminated. Unsuccessful ergonomics programs will either be stopped by these barriers, or will be overcome by them. There are four typical barriers within an ergonomics program as shown in Table 10.3. In addition, some typical methods to overcome these barriers are also listed.

It is important to address barriers to the success of the ergonomics program early and often. The most successful programs will address barriers during the initial strategic planning, and will discuss barriers during each planning session. Once the barriers are identified, corrective actions are planned and implemented, and follow-up is done to ensure that the barriers are not impeding progress with installation.

Training Should Be Supported by Suitable Infrastructure

Training is a valuable part of an ergonomics program, but it can be done before the organization is ready for it. One important objective of an ergonomics program is to ensure that people are aware of the signs and symptoms of musculoskeletal disorders. General awareness training of these disorders is an appropriate way to meet that need. But what happens too often is that this awareness training occurs much too early in the program. Once this training takes place, many ergonomic concerns quickly come to the surface — some very important, but many of less significance. The dilemma is that each situation should be evaluated reasonably soon or the ergonomics program loses credibility. When an operator recognizes an ergonomics problem and asks for help, there is a limited amount of time before the worker suspects that ergonomics is just another management fad.

When numerous situations surface at once, particularly if the ergonomics program is new, there are insufficient resources to deal with everything in a timely manner. This creates a big problem for the ergonomics program — too many requests, not enough time, and lots of frustration, discontent, and loss of credibility.

This is clearly a situation which a successful ergonomics program should avoid, and the recommendation is to wait for the ergonomics program to mature a bit and develop a suitable infrastructure of people with some basic skills prior to conducting widespread training. An organization which has performed passive or active surveillance is well aware of the more serious problems anyway, and is probably already dealing with them. Therefore, little is lost by waiting to perform training, and the ergonomics program will avoid generating substantial negative publicity and discontent.

Avoid Using “Ergo-Babble”

One common contributor to the lack of success of an ergonomics program is the extensive use of technical jargon. This “ergo-babble” is rarely understood and results in a loss of support by managers and the line workforce. Often, after a long (and difficult-to-understand) medical term has been used to describe a workplace illness, the operator is left in the dark and is only too willing to leave the situation to the “doctors and engineers” to fix. Unfortunately, many ergonomic problems which could be corrected by operators are left untouched once this scenario begins to play out.

It often takes more effort to describe a musculoskeletal illness in terms a lay person can understand, but the effort is worthwhile in gaining support for the ergonomics program.

Clearly Define the Purpose of Your Ergonomics Program

The successful ergonomics program has a clearly defined objective. Programs which flounder and fail have unclear objectives. Programs which have been put in place to “do ergonomics” will likely fail relatively quickly. Defining the objectives may take the form of a mission statement or vision statement. Typically, vision statements are longer than mission statements, and “paint a picture of what life will be like at some point in the future.” Some examples are provided in Tables 10.4 and 10.5.

TABLE 10.4 Examples of Mission Statements

Mission Statement	Comments/Observations
<p>Example #1 The Ergonomics Committee will develop systems for the multi-disciplinary study of the problems that exist between people, the tools and machinery they use and their work environment. These systems will initially focus on reducing injuries/illnesses related to cumulative trauma disorders of the upper extremities and backs by hazard prevention and control, medical management, and training/education. This will lead to an increased level of comfort at work, improved quality of product, and greater productivity. This mission will be obtained with management support and associate involvement.</p>	<p>Positive Points</p> <ol style="list-style-type: none"> 1. Takes ergonomics beyond injury/illness into quality and productivity 2. Will not do all the work itself, but will develop systems for ... <p>Areas of Concern</p> <ol style="list-style-type: none"> 1. Overemphasis on CTDs 2. Somewhat long 3. Mentions how this will be achieved which may be unnecessary
<p>Example #2 The Ergonomics Committee will develop and manage systems for the improvement of the conditions between people, tools, machinery, and their work environment.</p>	<p>Positive Points</p> <ol style="list-style-type: none"> 1. Short 2. Will develop systems for... <p>Areas of Concern</p> <ol style="list-style-type: none"> 1. When is the mission completed?
<p>Example #3 The ergonomics program provides education, analysis, and guidance to prevent and alleviate ergonomically related stress and illness in order to protect the health, and further, the productivity of the plant.</p>	<p>Positive Points</p> <ol style="list-style-type: none"> 1. Mentions prevention 2. Relatively short <p>Areas of Concern</p> <ol style="list-style-type: none"> 1. The program should set up systems to provide... because when the program ends ergonomics will be part of the culture 2. Ergonomics can go beyond stress and illness (it is not just CTDs)
<p>Example #4 To put into place the will and skill to eliminate and/or prevent ergonomics problems (pain, illness, injuries), and to capture quality and efficiency benefits so that ergonomics becomes institutionalized.</p>	<p>Positive Points</p> <ol style="list-style-type: none"> 1. Will put into place ... 2. Relatively short 3. ... becomes institutionalized <p>Areas of Concern</p> <ol style="list-style-type: none"> 1. A little wordy 2. Stilted language

TABLE 10.5 Examples of Vision Statements

Example	Vision Statement
Vision Statement #1	<p>The vision was addressed from two different time frames — long term and over the next 12 months. Both are important because they provide the framework necessary to build the appropriate program.</p> <p>Long Term</p> <ul style="list-style-type: none"> • Ergonomics is part of our culture. We don't think about it separately any more. • Ergonomics improves safety and health, improves plant performance (worker productivity, product quality, cost control) and improves the quality of worklife (QWL) of workers. • Ergonomics is used before as well as after injuries/illnesses occur. Prevention is common. • All aspects of human performance are considered part of ergonomics, including such issues as heat, stress, and human error. <p>Within One Year</p> <ul style="list-style-type: none"> • Ergonomics will be more commonplace with a great deal more awareness. There will be successful projects completed, ergonomics reviews of new designs, supervisors evaluation of jobs, and illness investigation procedures. • Ergonomics will still be primarily a safety and health issue. • The plant will be addressing all known problems. • The major areas of emphasis will be cumulative trauma disorders along with manual material handling type injuries.
Vision Statement #2	<p>The program will undergo a change in focus and activities. The focus will go from pain reduction to maximizing effectiveness on the job. Maximizing effectiveness on the job includes all aspects of performance, such as a safe and healthy workplace, the ability to produce high quality goods, highly productive workplaces that don't waste time and energy of the workers, and high quality of worklife. Ergonomics is one of several tools used to maximize effectiveness on the job.</p> <p>During and after the transition, there will be technical ergonomic resources available to the plants for projects and for auditing assistance. Auditing for ergonomic concerns will become part of normal auditing procedures used for other safety and health audits.</p>
Vision Statement #3	<p>The guiding principles involved with this organization are:</p> <ul style="list-style-type: none"> • to push problem solving down to the working level in the organization, • to spread ergonomics throughout the organization by heavily involving others, • to avoid making ergonomics an "overlay" that just adds work, and • to ensure that ergonomics solutions dovetail with other changes being made. <p>These principles dictate that the ergonomics task force be more of a facilitator, technical resource, and trainer than a problem-solving group. Where appropriate, the Ergonomics Committee will either work with a group who is already studying a job or task, or will request a specific problem-solving team to consider the ergonomics issues. If a team is not available, then the Ergonomics Committee may work on the project itself.</p>

Plan the Stages of the Ergonomics Culture Change

Successful ergonomics programs are guided by a knowledge of organizational culture change models. There is a body of knowledge generally titled "change management" which deals with change in organizations. One especially helpful part of this technology is that it outlines the steps which must be followed before commitment to successful organizational change occurs. As the ergonomics program matures, it goes through six distinct stages, each with separate concerns and issues. The six stages, using layman's language, are:

1. *Awareness* that a change is necessary (e.g., injuries are excessive)
2. *Acceptance* of ergonomics as a tool that can help
3. *Trial* using ergonomics to see if it works
4. *Regular use* of ergonomics because it does work
5. *Procedures* written to include ergonomics
6. And finally, a *culture* that is totally supportive of the use of ergonomics

These stages are outlined in Table 10.6, along with brief comments about some key issues.

TABLE 10.6 Stages of an Ergonomics Program

Area:	Stage 1 Awareness	Stage 2 Acceptance	Stage 3 Trial	Stage 4 Regular Use	Stage 5 Procedure	Stage 6 Culture
Brief description of stage Ergonomics	Learning about ergonomics “Ergo-What?”	Positive image of ergonomics Oh, yes, ergonomics. That sounds interesting	Willingness to give it a try Ergonomics — it should reduce injuries	Multiple ergonomics projects Ergonomics is more than injury prevention	Ergonomics in operating and design Ergonomics is human performance	Inconceivable not to use ergonomics Ergonomics helps with every aspect of our business
Results	None	None (But wants to hear about success stories from others in this industry)	Very limited (Results only with specific projects — still going on faith)	Paying off (Still used mainly for injury prevention)	Solid benefits (Results in safety and health, performance, cost reduction)	Solid benefits (But little need to measure benefits any longer)
Management feelings	Skeptical	Acceptance (grudging to willing)	Prove it to me! (On our site)	Yes, it works, but can you do it again? And let’s show some payoff.	This stuff really works. I’ll have everyone use it.	“And why didn’t you think of ergonomics? We always use it.”
Ergonomics Committee feelings	Why us?	Learning	OK, I hope it works.	I hope these other people understand it like we do.	All we do is training. Will we ever get done?	That was a great committee. I’m glad I was on the team!
Role of Ergonomist	Advocate	Assurance of others	Leading the effort	Facilitator and training	Builder of others; ensures systems in place	Maintenance

Unfortunately, few people are familiar with the stages of change or with the pitfalls that occur when the stages are not followed. The most common problem results from the tendency to skip the first two stages of creating awareness and acceptance. The next most common problem is to attempt to jump over stages, for example, by going from “Stage 1 — Awareness” to “Stage 5 — Procedure.” While jumping any stage causes resistance to the change, jumping multiple stages creates even more resistance.

Another way to look at the program stages is to think in terms of child development, from infant, toddler, child, adolescent, young adult, and finally mature adult. As the child grows, its needs change and it no longer responds to things the way it once did. An ergonomics program is very similar.

Create a Strategic Plan

Successful ergonomics programs have a strategic plan. A strategic plan is necessary to guide the ergonomics program. The strategic plan defines what the ergonomics program intends to accomplish over the long term. Some organizations use vision statements or mission statements to describe program objectives, and these are very helpful concepts for the program.

However, a mission or vision statement, by itself, is not sufficient to fully describe the strategic plan. To develop the strategic plan, the following questions need to be discussed and answered:

- A. *What do we want the ergonomics program to do?* This usually becomes the mission, vision, and scope of the ergonomics program.
- B. *How do we monitor results?* What data do we measure to demonstrate progress with ergonomics?
- C. *What are the barriers?* And how can they be overcome?
- D. *What policy issues* are likely to be affected?
- E. *Who is/should be involved, and what are their roles?* This includes both the ergonomics committee and ergonomics problem-solving groups.
- F. *What is the priority?* How long should it take to finish the job? What resources are available to us?
- G. *When and how should we review our plans* and progress with management? Are there others who need to hear our story?

Understand the Difference between an Ergonomics Program and the Practice of Ergonomics

Many ergonomists have had training in the identification, analysis, and resolution of ergonomics problems. They have not typically had training in the management of complex programs such as the ergonomics program. Without this background, they have difficulty visualizing the roll-out of the program, planning for resources, estimating degrees of success, and conceptualizing how the ergonomics program will mature and what it will be like once it is completed.

It is important to clearly distinguish the two areas and the skills necessary to be successful at each. If it is necessary, provide both program management support and ergonomics technical support for the ergonomics committee. Ergonomics technical support may be provided by the ergonomist while program management support is provided by a mid-level manager. Figure 10.5 provides a distinction between the two areas.

Create a Tactical Plan

The strategic plan is necessary but not sufficient for ergonomics program success. There are two types of plans which are necessary for a successful ergonomics program:

- Strategic plans determine what we are trying to accomplish
- Tactical plans determine specifically how we accomplish those goals

A tactical plan is the month-to-month and week-to-week plan which outlines the jobs to be analyzed, the procedures to be written or reviewed, the training to be accomplished, and the solutions to be implemented. Many ergonomics programs fail to develop tactical plans. Some people develop initial plans but then fail to maintain them.

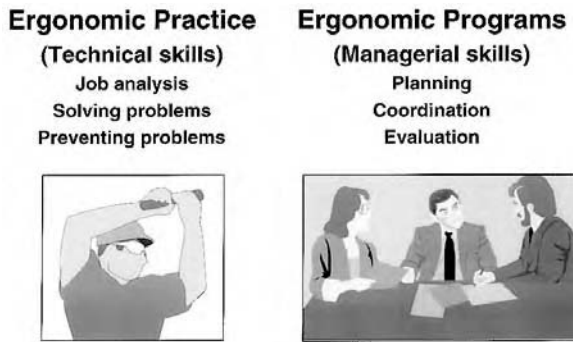

FIGURE 10.5 Ergonomics practice and ergonomics programs.

High-quality tactical plans should be developed initially, then monitored to ensure that the planned activities are accomplished. Experience with the most successful ergonomics programs indicates that tactical plans must be reviewed monthly, revised quarterly, and fully reviewed and updated semiannually.

Sound tactical plans are the key to obtaining funding and personnel to accomplish the ergonomics program goals. Once the tactical plans are developed, management can easily see the costs (financial resources and personnel) as well as the benefits (expected improvements from proposed projects). This makes approval of the ergonomics program plans easier, and allows management to clearly understand what to expect from the ergonomics program.

In developing the tactical plan, the following questions must be answered many times:

- What activities should be done?
- When should they be done?
- Who should do them?
- What are the quality standards?

An example of some activities found in a tactical plan is shown in Table 10.7.

Ensure That There are Regular Quantitative Evaluations of the Overall Ergonomics Program

Successful ergonomics programs measure themselves. And they do it regularly and often. The adage “you can’t manage what you don’t measure” is certainly true when it comes to ergonomics programs. Yet, few ergonomics programs are quantitatively measured on any regular schedule. With beginning programs, rigorous evaluations are seldom required. However, as an ergonomics program begins to mature and the “honeymoon period” ends, management often asks about progress and results. Without ongoing evaluations, it is difficult to respond with any specificity to these questions. There are a number of audit and assessment tools available to evaluate ergonomics programs, and an example is provided using the assessment tool *Assessing Your ERGONOMICS Program* developed by Auburn Engineers. This audit tool is widely used, in part because of its simplicity and ease of use. It has 50 multiple choice statements, and requires less than one hour to complete.

An example of the scoring provided by *Assessing Your ERGONOMICS Program* is shown in Figure 10.6.

The interpretation of this assessment is equally easy. From the bars shown in Figure 10.6, these conclusions can be drawn:

1. The areas of organization, medical management, and correction are adequate.
2. There is a need for more balance in this program because there is a large gap between the best and worst areas assessed.
3. There is a need for more work on prevention and on demonstrated results.
4. This is average progress for an ergonomics program which is 6 to 12 months old.

TABLE 10.7 Abbreviated Example of a Tactical Plan

WHAT?	WILL BE DONE BY WHOM?	BY WHEN?	Check When Complete
1. Plant strategy developed	Committee	May 5	
2. Ergonomics policy written	Committee	May 5	
3. Roles/responsibilities developed	Committee	May 5	
4. First problem solving training	Don	June 3	
5. Initial 2 projects started	Todd, Mary and teams	June 6	
6. Baseline data collected for measurement systems	Alice	June 12	
7. Initial project recommendations implemented	Todd, Mary	July 15	
8. Next 2 projects initiated	Maria, Jude and teams	July 6	
9. Illness investigation procedure tested	Bruce	July 20	
10. Project recommendations implemented	Maria, Jude	August 20	
11. Next 2 projects initiated	Cindy, Ron and teams	August 4	
12. Detailed surveillance completed	Bruce	August 16	
13. Policy issues identified	Mike	August 24	
14. Project recommendations implemented	Cindy, Ron	September 24	
15. Next 2 projects initiated	Todd, Maria and teams	September 7	
16. Plans for proactive ergonomic program developed	Ivan	September 9	
17. Project recommendations implemented	Todd, Maria	October 12	
18. Next 2 projects initiated	Mike, Randy and teams	October 5	
19. Engineering training started	Ivan	October 14	
Continued			



FIGURE 10.6 Scoring the success of an ergonomics program.

More information on ergonomics program evaluation can be found in the chapter titled “Evaluation of Ergonomics Programs.”

Do Not Wait for Top Management to Push the Program Down

Unfortunately, for many programs, a litmus test of acceptance is the degree to which top management supports the program. Top management support is too often seen as a requirement for ergonomics program success, and without an endorsement, nothing happens.

Successful ergonomics programs do not require top management support. A caveat is important: this is not to suggest that one simply take on ergonomics projects with no management support or against management's directions. There are usually several layers of management within an organization, and one does not need to wait for top management endorsement to begin. Even with the support of lower level management, much can be accomplished, thus laying the foundation for a larger program later on. This initial success with positive activities and projects now permits the easy endorsement of the program by management.

There are several distinct advantages to getting things going, at least on a small scale, with some important projects. Clearly, this will begin the process of eliminating some difficult tasks, thus making the workplace a little safer. By starting with some projects, one can determine how to go about the process of solving ergonomic problems, thus gaining valuable experience. Many of these projects become examples of the types of changes which can take place with ergonomics, and therefore serve as good illustrations to use once the program begins to grow.

Finally, it is important to note that good ideas "catch on" on their own, while poorly conceived ideas are stopped or die from lack of interest. If ergonomics is seen to work well, it will take hold and people will soon be asking for help with more ergonomic projects. However, if the ergonomics program seems to go nowhere without the push from top management, then perhaps it is a poorly planned and ill-managed program.

Maintain Political Support

Successful ergonomics programs have internal political support when they need it. It is necessary to develop and maintain strong political support with the organization's safety and health committee, with senior management, and with key staff groups like engineering and health services.

This is done with frequent contact, seeking and using input, and by openly sharing what is happening. Even small successes should be shared with others, and credit should be passed liberally around the organization. Publicity plans should be developed which permit everyone who contributes to share in the limelight. If these things are done as the program grows, then the political support will be there when it is needed.

10.3 Conclusion

There is enough information regarding ergonomics programs to know what factors contribute to their success. An ergonomics program manager should review the sixteen factors, assess their presence in the program, and if they are missing, seek to implement them as soon as practical.

For Further Information

The Practice and Management of Industrial Ergonomics, David C. Alexander, Prentice-Hall, 1986.

The Top Ten Reasons Ergonomics Programs Fail, Auburn Engineers, Inc., Auburn, AL 1994.

Assessing Your ERGONOMICS Program, Auburn Engineers, Inc., Auburn, AL.

The Economics of Ergonomics, Auburn Engineers, Inc., Auburn, AL 1994.

The Economics of Ergonomics, Part II, Auburn Engineers, Inc., Auburn, AL 1995.

Advanced Techniques for Managing Your Ergonomics Program, a short course sponsored by Auburn Engineers, Inc. Some specific items used for this paper which are included in that course are:

- Selling Ergonomics to Management
- A Model Ergonomics Program
- Stages of an Ergonomics Program
- Defining the Ergonomics Culture
- Building Commitment to Ergonomics

11

Elements of the Ergonomic Process

Åsa Kilbom

*National Institute for Working Life,
Solna, Sweden*

Nils F. Petersson

*National Institute for Working Life,
Solna, Sweden*

11.1	Introduction	11-1
11.2	Organization of the Process	11-2
11.3	Identifying the Problem.....	11-4
11.4	Analyzing the Problem	11-4
11.5	Developing a Solution	11-4
11.6	Implementing the Solution	11-5
11.7	Evaluating the Result	11-6
11.8	Using the Results and Experiences for the Next Process	11-6

11.1 Introduction

During the ergonomic process, problems, potential or already apparent, are gradually worked out and brought to a solution. Problems may be similar but the contexts in which they appear are almost unique. Thus, the ergonomic process will hardly ever be the same, and experiences gained in one case cannot be applied mechanically to another place.¹⁵ Furthermore, there is very seldom only one possible solution, but many and probably quite different ones, depending on the culture and awareness at the workplace, its size and level of technology, and the human and financial resources available. Moreover, the chosen solution must comply with the aims of the organization which again influences the choice of solution. The ergonomic process in practice will consequently take different ways and differ considerably from time to time. However, some important steps or phases in the process can be traced in most cases^{14,19} and need to be handled for a successful outcome. These phases are: organization of the process, identifying the problem, analyzing the problem, developing a solution, implementing the solution, and evaluating the result (Figure 11.1).

All of these phases normally have to be present to achieve a good result. In most cases it is important to treat the different phases separately from each other and not to begin one phase until the preceding is completely finished. Too often solutions are presented before a thorough analysis is carried out, maybe resulting in a suboptimization.

Schneider²⁴ suggests three basic elements to implement an effective ergonomics program:

1. Establish ergonomics as a business function
2. Establish a predefined return on investment profile for workplace improvements
3. Establish goals and measure performance

He also argues for not using the word *ergonomics* as it often seems to be synonymous with costs; instead it should be emphasized that healthy people perform and work better. Improvements based on ergonomic investments as well as other investments should be evaluated on the basis of value. Other,

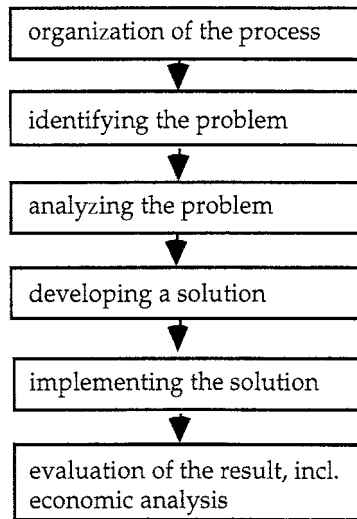

FIGURE 11.1 Important steps in the ergonomic process.

more complex elements of the ergonomic process have been reviewed by Wilson, e.g., the ergonomic design process.²⁹

Apart from the phases included in the process (Figure 11.1), a routine to take advantage of the experiences for the next project is also desired.

Ergonomic programs need time, and an underestimation may lead to failure to fulfil the program. One problem is modern management's focus on short-term goals and profit which can be hard to handle.³

Finally, an ergonomic process is characterized by its comprehensive view and multidisciplinary approach, taking both productivity and human aspects into consideration. The multidisciplinary approach must be considered in forming the team of the process, taking the participants' background into account.²³ Actually the next most important requirement, after involvement of the employees and management commitment, for a successful implementation of ergonomics is the multidisciplinary approach.²

11.2 Organization of the Process

Although the organization of the project or the process¹ many times does not start until the problem is identified or during this step, it is advisable to treat it separately from the problem analysis and problem-solving phases. It is common to have some sort of a fixed organization taking care of ergonomics. Big companies often have their ergonomics department or a health care service with ergonomic expertise. For example, Faville recently presented one approach for a large manufacturing company faced with a high rate of musculoskeletal problems.⁸ Another example is the nationwide occupational health service for the construction industry "Bygghälsan" which has been in operation in Sweden since the late 1960s.⁷ Through medical checkups every 2 to 3 years, a high prevalence of musculoskeletal disorders were identified. An ergonomic program was linked to the health surveys and gradually introduced improved work practices and technical improvements at the building sites.

Obviously, the preexistence of an organization dedicated to ergonomics will facilitate and speed up the identification, analysis, and implementation phases. Ideally, such an organization will already have

¹Throughout this text we use the term *project* for time-limited activities and *process* for those activities going on without any predetermined termination.

developed methods for surveillance of risk factors and health, a system for collaboration with production engineering and personnel departments, and pathways for feedback to management and employees.

In many countries, e.g., the Scandinavian nations, formal joint union–management committees, taking care of ergonomics, are prescribed and in other countries voluntary union–management groups appear in companies.^{18,22}

The process of continuous improvement, *kaizen*, has been introduced in many western companies and ergonomic projects may be integrated in these processes. When a preexisting organization is not in place, the emergence of an ergonomic problem can be an important factor triggering its development.

Lacking a preexisting organization, many different ways to organize an ergonomics project or process exist. One extreme is to hire an external consultant expert of ergonomics, and the other is to involve all concerned employees in the process without an expert. Although both systems appear and may be adequate in some cases the most effective organization, in general, lies somewhere in between, taking advantage of both. It is hardly possible for employees to master all different fields of ergonomics, and therefore not using an expert may result in nonoptimal solutions. Especially for small companies with limited technical expertise, the implementation of high-tech solutions without external know-how may result in costly mistakes. On the other hand, not using the knowledge of the employees can imply that important basic factors are not taken into account. A process where employees take an active part in all phases of the problem is usually called “participatory ergonomics” and is used successfully all over the world.^{13,20} Involving the employees most often facilitates the implementation through a greater acceptance of change, and adds problem-solving capabilities as the person doing the job often has the best insights in how to improve the work.^{2,11} By teaching workers fundamental ergonomic principles they can become responsible partners in the ergonomic process.³ The involvement of workers in the process leads to empowered workers,^{3,26} who can interpret accurately ergonomic needs and who become increasingly responsible for pushing the processes. The ergonomic training has to be “just-in-time-training” adapted to the real acute situation. Starting the training from one’s own situation, e.g., an evaluation of the worker’s own workstation, seems to be an appropriate method.⁹ Apart from training in ergonomics, training in team work and communication is also important.¹¹

Another prerequisite for success is management commitment.³ An ergonomic program is doomed to failure without visible support of the management and financial backing.²³ Schneider²⁴ too puts a heavy emphasis on management commitment to ergonomic improvements and argues that the onus for managing the ergonomic agenda is with line management. Active participation of all involved including management and supervisors has been found to be the most important factor in implementing ergonomics.² Chavalitsakulchai et al.² also argue for regarding government officers as vital for ergonomics intervention programs.

An organization pleaded for by some authors is the “system group” approach.¹ Representatives of all those concerned with the problem, i.e., ergonomics or health department, management, employees, production engineering, personnel, sales representatives, and customers (of the product or the service) form a group that meets to analyze the problem and develop a solution.

Important issues for team building and participative approaches have recently been summarized in a report from NIOSH¹¹ and are:

- *Management commitment*, from top management to supervisors
- *Training* in ergonomics, communication, feedback skills, technology, all tailored to the participants’ skills
- *Composition* of teams, tailored to the problem at hand
- *Information sharing*, within teams, to and from management and employees
- *Activities and motivation*, includes meetings, data gathering and analysis, and planning of remedies. Motivation is achieved by goal setting and feedback, commitment from management and rewards
- *Evaluation*, e.g., of team efforts and outcome of activities

In most cases a change agent, e.g., a production engineer or a safety professional, is recommended. Unfortunately, ergonomists often occupy low organizational positions which makes their negotiating position weak.¹⁴ Apart from the change agent, dedicated persons are of great value and an early identification of them — if they are present — is recommended.

11.3 Identifying the Problem

The title of this phase is not entirely appropriate as many ergonomic processes do not start with a real “problem” but are part of a development strategy. In fact, the reasons to start a process or project can vary widely and be divided either regarding their abode — a productivity or a health issue — or in how they occur. For example, the problem can appear as an acute incidence, e.g., an accident which has to be remedied. It can also emerge after a survey to identify critical factors, e.g., a bottleneck in the production or a work task creating musculoskeletal disorders. Third, the problem can be identified as the result of a conscious and continuous improvement procedure, e.g., activities in quality circles. Depending on what type of problems and by whom they are identified, the ensuing process will differ regarding both organization and solutions identified.

Both for a temporary survey and a long-lasting improvement procedure, some supporting devices exist to facilitate the problem identification. Group discussions based upon photos or videos are often efficient. Brainstorming is another method both for the problem identification and also later in the solution phase. Short courses in ergonomics, including a workplace-based project, can make problems evident. An ergonomic training program including an evaluation of workstations can be effective. The evaluation of the worksite should include not only physical aspects of the workplace but also analysis of work methods, product flow, and maintenance of tools.²³

Other sources for problem identification may be internal statistics, e.g., sick-leave or numbers of health care visits. Benchmarking and other quality methods⁵ are still other ways to be aware of problems.

It is important to have systems which encourage workers who have early symptoms to report these.³

The problem phase may end up with frame settings regarding the costs and time accepted for the project.

11.4 Analyzing the Problem

The analysis phase includes, apart from a thorough analysis of all the components of the problem, also the analysis of the consequences if the problem remains unsolved and the obstacles remain for a solution.

Both in the step of identifying the problems as well as in the analyzing phase one way to start is to ask (1) What is the purpose of the work performed? (2) How are the functions in the work process allocated between humans and technology?²⁶ For work-related problems a task analysis is a good base²⁷ and in product development a function analysis is recommended.²⁹

When analyzing the components of the problem, it is important not to limit the scope only to the imminent problem. Sometimes the optimal solution is not confined to the work process where the problem was identified, but to work processes or technology used in a preceding process.

The analysis should also contain the goals and the criteria for the solution. Goals are preferably expressed in measurable quantitative terms, e.g., a certain increase in productivity or reduction of sick leave. Fuzzy goals have to be operationalized, i.e., translated and expressed into concrete ones.¹⁷ Skill in defining goals is essential for measuring ergonomic progress.

11.5 Developing a Solution

As stated in the introduction, there is seldom only one solution. If the analysis is carried out thoroughly, the solutions are normally easy to find.

Solutions are traditionally subdivided according to their approach into engineering, administrative, and behavioral.¹² Engineering approaches can be redesign of a machine, a workplace, or a tool; administrative

approaches are changes of work processes, e.g. job rotation, job enlargement, or reallocation of tasks between machines and humans; and behavioral approaches attempt to influence attitudes or behaviors toward risks and changes at work. Training is sometimes classified as an administrative, and sometimes as a behavioral approach depending on the content.

The problem analysis phase should ideally identify the most promising and feasible approach in the individual case. A cost benefit analysis of the chosen solution should be undertaken, and in the case of several feasible approaches, such an analysis can assist in choosing the best. Although one approach usually dominates, the solution commonly contains (and should contain) elements of all three approaches. Most administrative approaches focus on work organization which is one part of the macroergonomic concept. Commonly, engineering and behavioral solutions are the first ones considered, especially in organizations with limited experience in ergonomic problem solving. However, in a process of continuous changes it will soon be evident that administrative approaches are also necessary. These changes sometimes meet more resistance in an organization and are more far-reaching, and they often require more experience.

The analysis phase also includes a thorough time planning and an allocation of tasks to those concerned. Information about the stages of the analysis, from concepts to detailed plans, is important for acceptance by all those directly or indirectly involved.

Many of the methods used in the problem identification phase are also appropriate in the solving phase, e.g., group discussions and brainstorming. Other means are sketches, models, full-scale mock ups. Literature review, Net search, and visits to other sites should not be neglected.

11.6 Implementing the Solution

In many cases the implementation phase seems to be the most critical one, calling for special care and time. Many projects have turned out unsuccessful due to an underestimation of the problems in the implementation phase. This is common in projects carried out by an external expert with no or little involvement by the employees/users during the preceding phases.

A change process, generative or innovative,⁶ is very seldom a straightforward action which can be planned in detail. Instead it is a movement with many loops and to's and fro's. Those responsible must be adaptable and ready to change the plans, keeping the main purpose in mind.

As mentioned above, all projects include organizational changes, even those regarded as purely technical projects. Neglecting this fact may be disastrous. Organizational changes are a threat to most people. According to Gardell, resistance to change originates in a threat to the following circumstances: job security, material standard, social status, social relations, and freedom of movement.¹⁰ Szilagyi and Wallace, using a somewhat different classification, distinguish the following reasons for resistance: fear of economic loss, potential social disruption, inconvenience, fear of uncertainty, and resistance from groups.²⁸

The resistance to change is a serious threat to the implementation of a program, and the best way to handle it is by continuous information. Access to necessary information is one of the most important factors promoting a program.² Misunderstandings are often a source of resistance. The main goals must be stated clearly and very early to all concerned.

A participative approach or a system group approach with representatives among all those involved in the change is very useful to forestall the resistance. The following approaches will facilitate the implementation:

- Provide possibilities to influence the solutions
- Offer longer time to comprehend
- Reconcile differences between different personnel categories
- Set up effective channels for information and communication

Resistance may also occur due to a fear of new technical equipment if those involved are not given enough and appropriate training. Training should be planned for and incorporated into all projects of

change. The training has to be adjusted to the special situation and occur at the proper occasion, and should preferably be conducted at the worksite rather than in classrooms.¹⁶

Another source of resistance may be former changes which have not been accomplished in a proper way or have resulted in deteriorations.

11.7 Evaluating the Result

Commonly, the evaluation of an ergonomic change process is based only on perceptions and random observations, without quantitative data support. Such an evaluation implies a risk that unspecific, short-lasting effects are recorded as specific consequences of the change (Hawthorne effects). As a consequence, the effectiveness of the change can be seriously misjudged.

Although ergonomic changes at the workplace are usually not research projects, some lessons can be learned from intervention research.²⁵ One important experience is to plan for the evaluation soon after the analysis stage, when the goals of the process have been identified. Moreover, data describing the situation before the change process are needed for the evaluation. Since the implementation of changes is a dynamic process, the evaluation should ideally be a continuous process where short- as well as long-lasting effects are monitored. Efforts to push the change process may result in a temporary dip of productivity during the changes. Such dips must not be interpreted as a failure. In line with the multi-disciplinary character of ergonomics, the evaluation should include productivity and economic, as well as health aspects. Obviously, this evaluation is vastly facilitated if a change agent, or an ergonomics department, is in charge of the program and if a system for monitoring is already in place.

The outcome of the ergonomic process should also be evaluated in economic terms.^{23,24} The easiest way for this analysis is to balance the costs of implementing the changes, including the investments, against the likely savings, i.e., reduced incidence of injuries, increases in productivity and quality, reduced staff turnover (including training new staff), etc. In a similar way, alternative approaches to improvements can be compared to select the most cost-effective solution. As demonstrated in many case studies, the payback period for ergonomic improvements is frequently only a few months.²¹

11.8 Using the Results and Experiences for the Next Process

The ergonomic process creates a vast amount of experience and knowledge among all concerned. This experience must not be discarded but should be used for future processes. The evaluation of the program should focus not only on the outcomes in quantitative terms. The process of development and implementation of the program can also be assessed and expressed in qualitative rather than quantitative terms.⁴ A protocol where the process is described and where the experience obtained is documented is therefore a valuable tool for future work. It enables those responsible to analyze the reasons for successes and failures, and in this way the ergonomic process can achieve results far beyond those of a single project.

References

1. Andersson E. A systems approach to product design and development; an ergonomic perspective. *Int J Indust Ergon* 1990; 6:1-8.
2. Chavalitsakulchai P, Okubo T, Shahnavaz H. A model of ergonomics intervention in industry: case study in Japan. *J Human Ergol* 1994; 23: 7-26.
3. Dawkins S. Does ergonomics work? *Manag Office Tech* 1995; 40(3): 12-14.
4. Dehar M-A, Casswell S, Duignan P. Formative and process evaluation of health promotion and disease prevention programs. *Evaluation Review* 1993; 17(2): 204-220.
5. Drury C. Ergonomics and the quality movement. *Ergonomics* 1997; 40(3): 249-264.
6. Ellegård K. Förändringsarbete och förändring — perspektiv på Volvo Uddevallaverken i efterhand. (The process of changes and its result — perspectives of the Volvo Uddevalla plant. In Swedish). Nordiska Ergonomisällskapets Årskonferens NES '94, 1994: 170-173.

7. Engholm G, Englund A. Morbidity and mortality patterns in Sweden. *Occ Med State of the Art reviews*. Construction safety and health. 1995; 10: 261-268.
8. Faville B. One approach for an ergonomics program in a large manufacturing environment. *Int J Indust Ergon* 1996; 18: 373-380.
9. Fragala G. Get more from your ergonomics training. *Manag Office Tech* 1995; 40(11): 45-46.
10. Gardell B. Arbetsanpassning och teknologisk miljö (Work adaptation and technological environment. In Swedish). In Luthman G, Åberg U, Lundgren N, Eds. *Handbok i ergonomi*. 2nd ed. Stockholm: Almqvist och Wiksell, 1969: 546-573.
11. Gjessing C, Schoenborn T, Cohen A. *Participatory Ergonomics Interventions in Meatpacking Plants*. NIOSH, Cincinnati, 1994:
12. Goldenhar L, Schulte P. Methodological issues for intervention research in occupational health and safety. *Am J Indust Med* 1996; 29: 289-294.
13. Imada A. The rationale and tools of participatory ergonomics, in Noro K, Imada A, Eds. *Participatory Ergonomics*. London: Taylor & Francis, 1991: 30-49.
14. Kuorinka I. Tools and means of implementing participatory ergonomics. *Int J Indust Ergon* 1997; 19: 267-270.
15. Kvarnström S. Organizational approaches to reducing stress and health problems in an industrial setting in Sweden. *Conditions of Work Digest* 1992; 11(2): 227-232.
16. Luopajarvi T. Workers' education. *Ergonomics* 1987; 30: 305-311.
17. McCoy T. Getting to the seat of the matter: Ergonomics can improve worker safety and productivity. *Rehab Management* 1994; 2: 116-119.
18. Moir S, Buchholz B. Emerging participatory approaches to ergonomic interventions in the construction industry. *Am J Indust Med* 1996; 29: 425-430.
19. Moore J, Garg A. Use of participatory ergonomics teams to address musculoskeletal hazards in the red meat packing industry. *Am J Indust Med* 1996; 29: 402-408.
20. Nagamachi M. Requisites and practices of participatory ergonomics. *Int J Indust Ergon* 1995; 15: 371-377.
21. Oxenburgh M. *Increasing Productivity and Profit Through Health and Safety*. Sydney: CCH International, 1991.
22. Reid P. *Well Made in America: Lessons from Harley-Davidson on Being the Best*. New York: McGraw-Hill, 1990.
23. Ross P. Ergonomic hazards in the workplace; assessment and prevention. *AAOHN Journal* 1994; 42(4): 171-176.
24. Schneider F. Targeting ergonomics in your business plan. *Manag Office Tech* 1995; 40(9): 28-30.
25. Skov T, Kristensen T. Etiologic and prevention effectiveness intervention studies in occupational health. *Am J Indust Med* 1996; 29: 378-381.
26. Springer T. Managing effective ergonomics. *Manag Office Tech* 1994; 39(3): 19-24.
27. Stammers R, Shepherd A. Task analysis, in Wilson J, Corlett E, Eds., *Evaluation of Human Work*. London: Taylor & Francis, 1995: 144-168.
28. Szilagyi A, Wallace M. *Organizational Behavior and Performance*. (5th ed.) Glenview: Foresman, 1990.
29. Wilson J. A framework and a context for ergonomics methodology, in Wilson J, Corlett E, Eds. *Evaluation of Human Work*. London: Taylor & Francis, 1995: 1-29.

12

An Ergonomics Process: A Large Industry Perspective

12.1	Introduction	12-1
	Background • Chapter Organization • Statement of Need • Definition of Ergonomics	
12.2	Organizational Issues in Developing a Comprehensive Ergonomics Process	12-3
	Organizational Models — Traditional and New • Ways to Effect Change in Industry • Traditional Ways to Effect Change — The Expert Approach • Concluding Statement on Needs of a Participative Program	
12.3	Recommended Methods for Implementing a Plant Ergonomics Program	12-9
	Setting Up and Implementing a Plant Ergonomics Program • Training Needs for a Plant Ergonomics Program	
12.4	Recommended Methods of Data Collection	12-16
	Proposed Methods of Data Collection	
12.5	Computers, Internets, and Ergonomic Communication	12-23
	Introduction • Communication and Information Flows • Challenges to Effective Communication • Using Computers to Overcome Challenges	
12.6	Lessons Learned	12-28

Bradley S. Joseph
Ford Motor Company

Susan Evans
Sue Evans & Associates, Inc.

12.1 Introduction

Background

Ergonomics in the manufacturing arena is a fairly new science and not well known. Even though it has been taught in various forms through traditional academic institutions, it has just recently been viewed as a useful approach to “fitting jobs to people” in order to reduce work-related injuries and illnesses, and to produce a host of other operational benefits. Although almost every facet of a manufacturing company stands to benefit from improved job design through ergonomics, certain organizational and knowledge-based barriers to change make the adoption and wide application of ergonomic principles a difficult process.

Many recommendations in this chapter are based on research into traditional and more modern theories of organizational politics and of organizational change. In addition, these recommendations are based on a set of basic assumptions and beliefs that are reinforced by experiences in the auto industry:

- The practice of ergonomics works most effectively through the participative, rather than the expert, approach
- Adequate training of participants at all levels is essential. General introductory training should be provided for all participants, while special topic training should be available for designated individuals
- The structuring of ergonomics committees, teams, task forces, or other groups must suit the organization within which they function
- The selection of committee members is critical. Representatives from workers, supervision, management, and union should be included; all areas affected by ergonomics should be represented
- Securing top management commitment is essential for success

Chapter Organization

This chapter is divided into five main sections:

- The introduction is devoted to background information on ergonomics.
- Section two discusses the theory and practice of participative management in large organizations.
- The third section, Recommended Methods for Implementing a Plant Ergonomics Program, outlines a protocol for the establishment and maintenance of an effective participative ergonomics program.
- The fourth section, Recommended Methods of Data Collection, details existing and proposed data collection methods, for use in identifying ergonomics problems, justifying their correction, and evaluating their effectiveness.
- The fifth and final section discusses computer, Internet, and communication issues in an ergonomics program.

Statement of Need

Why is a chapter like this needed in an ergonomics handbook for practitioners? Neglecting ergonomic considerations in the workplace contributes heavily to the incidence of musculoskeletal disorders, e.g., low back pain and upper extremity cumulative trauma disorders. In addition, poor job design has been blamed for reduced productivity, poor quality, and increased absenteeism. In some industries, these disorders can occur in epidemic proportions, costing billions of dollars in health costs annually. Research findings suggest that changes in work practices and equipment design can substantially reduce the number of musculoskeletal injuries and substantially increase productivity and improve quality.

This concept has led to great advances in ergonomics research and knowledge. The output of this research is often in the form of models and guidelines to aid engineers in designing machines. However, despite increasing knowledge about ergonomics, changes to the workplace, whether to new or existing machines, still largely fail to incorporate ergonomic principles.

Therefore, even as more research is completed and more is known about the limits of the human body in the workplace, without an understanding of the organizational process that is now widely used, ergonomic factors will continue to be inadequately used in the workplace.

Definition of Ergonomics

Ergonomics is defined as the study of work. Chaffin and Andersson (1984) further define ergonomics as “fitting the work to the person.” Ergonomics is concerned with the problems and processes involved in designing things for effective human use, and in creating environments that are suitable for human living and work. It recognizes that work methods, equipment, facilities, and tool design all influence the worker’s motivation, fatigue, likelihood of sustaining an occupational injury or illness, and productivity.

Properly designed workplaces, equipment, facilities, and tools can:

1. Reduce occupational injury and illness
2. Reduce workers' compensation and sickness and accident costs
3. Reduce medical visits
4. Reduce absenteeism
5. Improve productivity
6. Improve quality and reduce scrap
7. Improve worker comfort on the job

The primary goal of ergonomics is “improving worker performance and safety through the study and development of general principles that govern the interaction of humans and their working environment” (Chaffin and Andersson, 1984). Rohmert (1985) states that ergonomics “deals with the analysis of problems of people in their real-life situations.” Further, he urges that ergonomists “design these relations, conditions, and real-life situations with the aim of harmonizing people’s demands and capacities, claims and actualities, longings and constraints.”

Ergonomics should not be associated with the measurement of work in the traditional sense. The ergonomist does not measure work only to set standards of time and productivity. That is a task best left to the industrial engineer, who performs motion and time studies using scientific measuring systems. Instead, the ergonomist identifies elements of the job that reduce the quality of the interface between the human operator and the workstation. A poor interface can cause unnecessary stress to the operator, leading to an increased risk of injuries and errors (which in turn may lead to an accident, poor quality, or a loss in productivity).

12.2 Organizational Issues in Developing a Comprehensive Ergonomics Process

Why has the workplace been deprived of something so useful as ergonomics? One explanation is that there is something internal to industrial organizations, such as communication breakdowns between designers and operators of workstations, or that there is something lacking in the knowledge base of the key actors, such as engineers who do not understand the principles of anthropometry, that erects barriers to proper ergonomic design. The operators, who often know the problems associated with workstations, do not communicate with the designers of the workstations early enough, and the designers of the workstation may not have the ergonomic expertise to design the workplace properly. This leads to design flaws that can contribute to ergonomic stress.

It is important to understand the complexity of industrial organizations when attempting to implement a health and safety (or any) program in the workplace. These organizations are usually very large and resist change. In order to be effective, the ergonomist or the organizer of the ergonomics program must understand how the organizations work and what can be done to overcome the barriers to change.

Below is a summary of basic organizational theory. This summary will help to explain and justify the need for developing specific types of ergonomics programs in plants.¹

Organizational Models — Traditional and New

Traditional organizational theory is largely based on the assumption that organizations are rational entities (Shafritz and Whitbeck, 1978). Allison (1971) calls this the Rational Actor Model. That is, an organization is a “system within which individuals and groups will act in internally consistent ways to

¹Note that parts of this section can be found in “A Participative Ergonomic Control Program in a U.S. Automotive Plant: *Evaluation and Implications*” by Bradley S. Joseph.

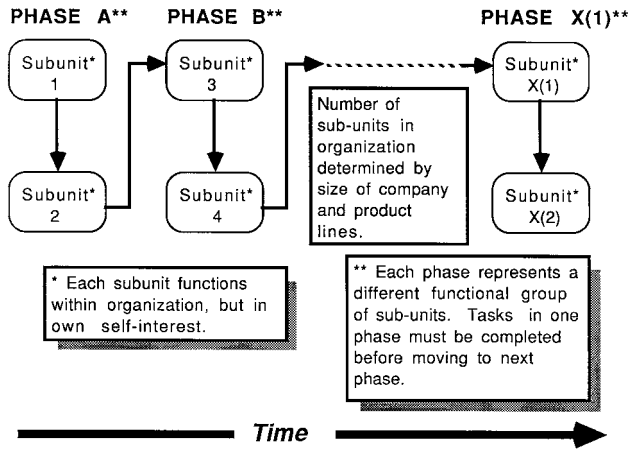

FIGURE 12.1 Simplified organizational politics model.

reach explicit objectives" (Tushman and Nadler, 1980). Therefore, organizations and their structures are "planned and coordinated for the most efficient realization of explicit objectives" (Tushman and Nadler, 1980). The theory blames behavior that violates these assumptions on ignorance, miscalculation, or managerial error within the organization, that is, error independent of either the organizational structure or the management approach. The theory assumes that organizational directions are explicitly and rationally planned. That is, organizations rationally choose goals that optimize an objective function. Managers' roles, as defined by traditional organizational theory, are rationally to plan, organize, coordinate, and control the organization's objectives (Koontz, 1964).

Traditionally, organizations are hierarchical systems involving top-down decision making. Top management decides on an objective for the organization (i.e., what it should be pursuing over the next several months) and instructs subordinates to follow a particular plan designed to reach that objective. These organizations are characterized by an extensive division of labor, including detailed job descriptions, tightly controlled departmental budgets, and narrow spans of supervisory control. This pattern effectively limits the opportunity of people to interact with one another either vertically or horizontally within the organization.

This model has done a satisfactory job in explaining why and how an organization, as a whole, reacts to a particular stimulus (e.g., a change in raw material prices). However, it often fails to explain or predict important aspects of organizational life (Tushman and Nadler, 1980). For example, while the organization as a whole may appear to be reacting consistently to crises or other stimulation from the environment, components within the organization often do not react in consistent ways. Too often, these inconsistencies cannot be explained solely by ignorance, miscalculations, or management error. Instead, the inconsistencies happen so often and are so overwhelming that they cause changes in the organization. Therefore, a new organizational model must be developed to explain these disparities.

One model that explains many of the disparities in industrial settings is called the Organizational Politics Model (see Figure 12.1). Allison (1971) describes this model (based on the work of Cyert and March, 1963, and March and Simon, 1958) in a book which examines the decisions leading up to and during the 1962 Cuban Missile Crisis. He argues that in this case study the rational actor model does not adequately explain many of the critical events or answer critical questions.

The basic principle of the organizational politics model is the concept of organizational units. Within the bureaucracy, e.g., a corporation, these organizational units will act in their own self-interest to achieve their desired goals. This behavior will lead to conflicts between units with different goals, differing perceptions of how to reach a common goal, or joint dependence on scarce resources (March and Simon, 1958; Pfeffer, 1977; Schmidt and Kochan, 1972).

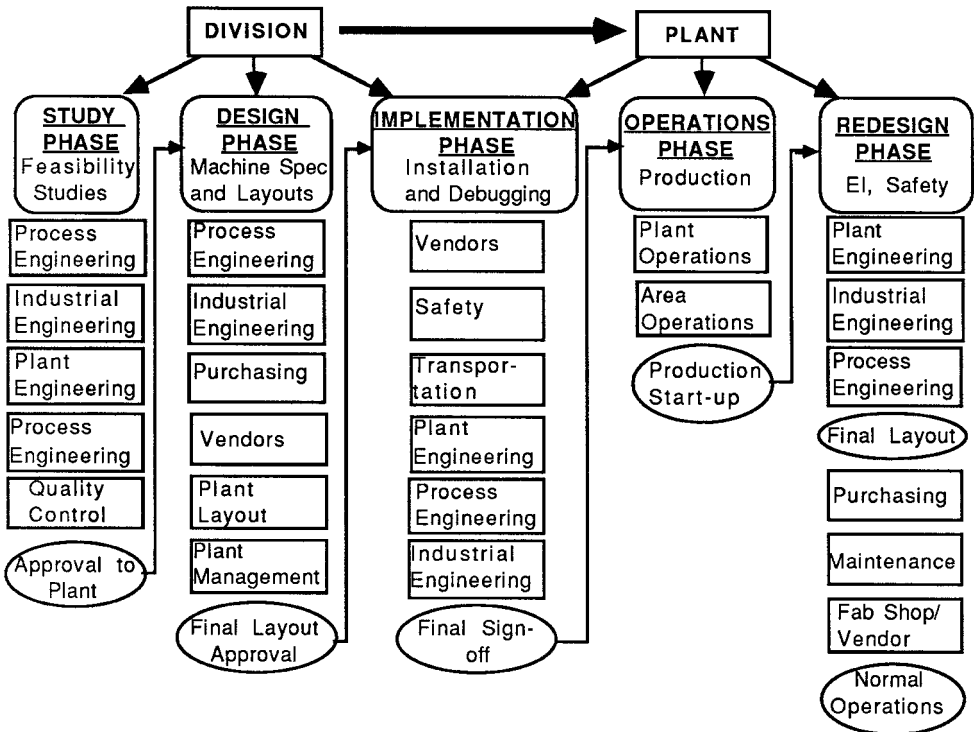

FIGURE 12.2 Organizational process for the installation of new and the maintenance of existing equipment.

The organizational politics model fits well in current U.S. industrial settings, particularly now that budget cutting and increased workloads are placing increasing pressures on individual subunits. All these pressures have occurred without subsequent change in the basic organizational structure. Units are still expected to operate with the same or even greater productivity as before the budget cuts. Because they fear for their very survival, subunits consult their self-interest to a point where it is detrimental to the effective operation of the whole organization. Often these subunits may be organized into a matrix that attempts to break down individual unit self-interest. However, this only works if subunits work with each other as a team.

An example of the organizational politics model is shown in Figure 12.2. The organizational process of a division and plant that produces chassis and suspension components and rear axles was analyzed. Figure 12.2 shows the complexity of the organizational process required for the installation of new and the maintenance of existing equipment within this division.

In this example, a series of units are grouped together into phases. The phases represent periods of time during which groups of units have to complete a task before passing it on to the next phase. First, new processes are studied (study phase) and designed (design phase) at division engineering. Little plant input is solicited in this phase.

Next, division and plant engineering together install and debug machinery (implementation phase). This procedure involves a complex series of actions whereby process plans are sent to selected vendors, interpreted and built to specifications, delivered, and installed in the plant, using resources from the plant, the vendor, and the division. Unless the plant is willing to bear costly delays and excessive expenditures, few changes can be made on machinery, for ergonomic or any other reason, between the time the vendor builds and the time he delivers it, because the vendor has signed off on machine specifications and is under contract to build it to standards agreed upon by the plant and division. Consequently, the

plant must wait until the machines are delivered and operating under those specifications (known as final sign-off) before changes can be made.

After debugging, normal operation and maintenance proceeds (operations phase). However, there is often a need for process improvements or other redesigns to update equipment (redesign phase). Depending on the cost, the plant usually controls these activities. However, due to limitations on cash and manpower resources, lost production from shutting down the machines, and other plant priorities, this activity is often limited in scope and takes a considerable time to complete.

According to the organizational politics model (Allison, 1971), this complex process, involving the interdependence of so many parties, offers a certain prospect of conflict. Moreover, the fact that those who make key decisions on manufacturing processes are geographically and organizationally separated creates a high probability of communications breakdown (Allen, 1977).

What are the implications of all this for ergonomics and other health and safety programs? In order to implement sound ergonomic design, we have to overcome two kinds of barriers:

- *The knowledge-based barriers*

1. A lack of general ergonomics knowledge (knowledge of ergonomic principles) — Ergonomics is a technical science. Persons involved in the designing, operating, and maintaining of machinery who lack the technical knowledge of ergonomics will be more likely to design workstations poorly.
2. A lack of specific job knowledge by workplace designers — People who operate jobs are most familiar with them. People who design jobs often do not know the specific information that pertains to daily operation (e.g., the process sheets and industrial engineering studies may vary from the designer to actual operation). This information is important when trying to determine job stresses, etc.

- *The organizational-based barriers*

1. A lack of communication between personnel involved in workplace designs — Players in each organizational unit must be able to interact with adjacent units to ensure that ergonomics is properly transferred along the organizational pathway. If for some reason this does not occur, then ergonomics, and many other considerations, may not be incorporated into the new job design.
2. A conflict between subunit interests — Each subunit has its unique set of goals. Therefore, things like budget, manpower, and time can all be important aspects of subunit performance and may reduce the cooperation between competing and/or successive units along the job installation pathway.

In order to correct this situation and eliminate the barriers, ergonomic or other changes to the workplace will best be accomplished by organizational interventions in combination with technical ergonomics training. Several mechanisms for managing technical change have been researched. They can be grouped into two categories: expert methods and participative methods. These will be discussed below.

Ways to Effect Change in Industry

Traditional Ways to Effect Change — The Expert Approach

Traditionally, major operational changes in large organizations are effected with the help of professionally trained experts. In the case of ergonomics, most manufacturing plants have to import this expertise from the outside. The experts bring their special knowledge to the plant, collect data, return to their labs to analyze it, and make recommendations for change based on their investigations. Once the experts have done their work, there is likely to be no one in the plant with sufficient initiative and interest to follow through with improvements.

Lack of involvement is more often responsible than lack of knowledge for this failure to follow up. In fact, many people in the plant possess potentially beneficial knowledge and skills, but they are rarely

asked to play a part in implementing ergonomic changes. For example, workers who do a job every day know it better than anyone else yet they are usually excluded from the job design process. As a result, workers may resist job changes and workplace designs that make sense technically, but in which they have had no stake.

New Ways to Effect Change — The Participative Approach

Worker–management participation itself is not new. However, industry in the United States has only recently started using worker–management participation on a large scale. In fact, there are ongoing debates if participation should be used in all industries. These debates are discussing a variety of issues including who owns the problem (labor or management) and if these committees undermine the collective bargaining process. This trend has primarily resulted in growing realization that American productivity, labor–management communication, and the overall competitiveness of American goods worldwide have not been keeping up with the world pace (Peters and Waterman Jr., 1982). By looking at companies in other countries, notably Japan, American managers have learned to make increasing use of their employees as a source of information for all areas of plant operations. Truly enlightened managers perceive people as their most important resource.

Experience suggests that the participative approach can ensure the effective continuation of a program long after the expert or consultant is gone. However, when contemplating the use of participation, management and labor must consider how effective it will be in accomplishing *specific* goals of the workplace.

Participation in Health and Safety Programs

Recently, health and safety issues have become of greater concern in industry, partly because of the creation of the Occupational Safety and Health Administration in 1970 and partly because of the realization that health and safety is a core process that can affect the bottom line as much as or more than other traditional programs. OSHA has increased both management's and labor's awareness of employee health and safety rights under the law, and legislation has inspired workers to take a more aggressive stance against observed violations. In fact, once a labor contract has been negotiated and ratified, most United Auto Worker shops throughout the country can strike for only one of two reasons: health and safety issues and productivity issues. This emphasis on health and safety has given managers who were reluctant to act an incentive to solve health and safety problems.

Several studies on the effectiveness of worker participation have been conducted. The W. E. Upjohn Institute funded a study (Kochan, Dyer, and Lipshy, 1977) to survey plants with union/management health and safety committees. Its intent was to determine how these committees function and to make a preliminary judgment regarding their effectiveness. General findings indicate that the committees with a high degree of continuity or high levels of interaction exist where OSHA pressure is strong, the local union itself is strong, rank and file involvement in health and safety is substantial, or management approaches health and safety in a problem-solving manner. This indicates that the most important attribute predicting a successful program was management and union commitment to solving health and safety problems rather than objective attributes such as frequency and length of meeting, number of members, existence of an agenda, and whether the committee was mandated by the collective-bargaining agreement.

Obstacles to Effective Use of Participative Problem Solving

Participative management and participative problem solving are not universal answers. Participation should be used for the kinds of programs in which it is known to be effective and for problems which are best addressed by a group process.

The quality circle is a good example of how participation can both succeed and fail (Lawler and Mohrman, 1985). In a manufacturing plant, a quality circle is a group which concentrates on solving workplace problems, usually those affecting the quality of the product, the quality of worklife, and working conditions. The quality circle works well with such problems, especially in early stages, and especially with easy problems. However, when the problems become more difficult or if the quality circle

program is expanded too rapidly, the confidence and the effectiveness developed early on quickly become eroded. Frustration and the increasing cost of the expanded program usually spell disaster.

An additional threat to quality circles, and one which is relevant to the participative approach in ergonomics, comes in the form of supervisor resistance. Supervisors, like many middle managers, often feel that quality circles (and other participative programs) undermine their authority and control. Their unwillingness to support the quality circle program greatly diminishes its possible effectiveness.

Another barrier to success in participative programs arises in the differing perceptions of what constitutes participation, and how it should be administered. Workers often have unrealistic expectations about what they can do. Managers often treat participation as a special program or campaign rather than a viable technique; or else they abruptly embrace participation, something which can throw the workforce into confusion. Finally, managers may not have the patience to wait for the long-term benefits of participation to appear before they scrap a program when they fail to secure early success.

In her book *The Change Masters: Dilemmas of Managing Participation*, Rosabeth Moss Kanter provides guidelines for appropriate and inappropriate uses of participation. These include:

Appropriate Use of Participation:

1. To assemble sources of expertise and experience among the workforce.
2. To tackle a problem that no one “owns” by organizational assignment.
3. To address conflicting approaches or views.
4. To develop and educate people through their participation (i.e., to develop new skills, acquire new information, and make new contacts).

Inappropriate Use of Participation:

1. When there is a “hip-pocket solution” (i.e., the manager already knows the solution).
2. When nobody really cares much about the issues.
3. When there is insufficient time for discussion and the group process.

Kanter also draws attention to five critical challenges, or what she calls dilemmas, which any participatory group must face and which must be overcome if the participative program is to succeed. These are the situations which have no easy resolution. They are as follows:

1. The beginning or setting up the program.
2. The organization of the program, in terms of structure and management.
3. The prioritizing of issues to be addressed.
4. The linking of teams with their environment so as to make them compatible with the existing organization.
5. The evaluation process, that is, determining whether the program is working.

Concluding Statement on Needs of a Participative Program

Role of Training in Participation

One of the most important requirements for success of any participative program is adequate training. In general, effective workplace education should consist of a process of instruction, reinforcement, and establishment of norms of behavior for workers (Vojtecky, 1985; Klein, 1984). It should provide guidelines on problem-solving skills and techniques in running a meeting. In essence, it gives participants the tools to perform their required functions in such programs. Many types of participative training programs are available. For example, Ford Motor Company trains all its employees before they are involved in participative problem-solving groups, emphasizing the basic skills outlined above.

For effective application of ergonomics, Shackel (1980) suggested that six factors must be addressed:

1. Ergonomics should be considered a science and a technology

2. Ergonomists should be researchers and practitioners
3. Ergonomics training and its content need constant updates and review
4. Presentation of data must be in a usable form for engineers, designers, and producers
5. The status of ergonomics must be high enough in the organization to make an impact
6. The ergonomists must have the necessary social skills to use ergonomics in the organization

Training addresses several of these factors. For example, training should teach theory and practice in order to give participants the skills to conduct research and to implement practical changes.

Even though ergonomics is a complex science, often requiring specialization in one area for the development of expertise, the complexity should not discourage the training of persons with average to lower levels of education. Knowledge is not necessarily a function of education level — a lot of knowledge comes from practical experience. The worker does not need to understand ergonomic models that explain the biomechanical cause of injury. Rather, the training needs to emphasize workplace configurations that lead to health problems and to provide understanding of how to reduce the risk associated with poor ergonomic design. Technical experts should be available to aid participants if they request more information or need more knowledge (Allen, 1977); they should play a resource, not an expert, role.

12.3 Recommended Methods for Implementing a Plant Ergonomics Program

This section outlines a recommended methodology for implementing a participative in-plant ergonomics program. The description of the three major steps is followed by a discussion of training needs. Note that although the steps are presented sequentially, some activities are best carried out concurrently in order to increase efficiency and reduce project overhead.

It is the opinion of the author that a participative approach to ergonomics is most effective. If your plant decides against the participative approach, only Step One (Securing Top Management Support) and Part Three of Step Two (Training) are relevant.

Setting Up and Implementing a Plant Ergonomics Program

All plants possess an operating organization which directs daily procedures. This organization requires that the proper authority be secured to begin implementing a program. In particular, health and safety programs require top management and labor support. Figure 12.3 outlines a process by which a program should develop at a plant.

Step 1: Secure top management and labor support — In order for a health and safety, in particular an ergonomics, program to be successful, management and labor must commit to the following:

1. Both management and labor must agree that the problem exists.
2. Management and labor must agree that the problems can be corrected.
3. Management and labor must agree that they will work together on solving the problems.
4. Top management must commit to the program by giving a high priority to the implementation of job changes recommended by the program. This includes, but is not limited to, a commitment from the maintenance department to fabricate and install the changes, a commitment of plant funds to pay for the changes, and a commitment from management to install the changes in a timely manner.
5. Top labor officials must commit and give a high priority to implementing and to using the changes.

Therefore, top plant management and labor must be in agreement that this program is important to the overall operation of the plant. In order to get this buy-in, it is often necessary to educate them. This education usually involves a presentation that defines the program, describes how it fits into existing plant programs and plans, and outlines its benefits and risks. Often this educational process can be supplemented by showing the audience case studies from their own and other facilities. These case studies

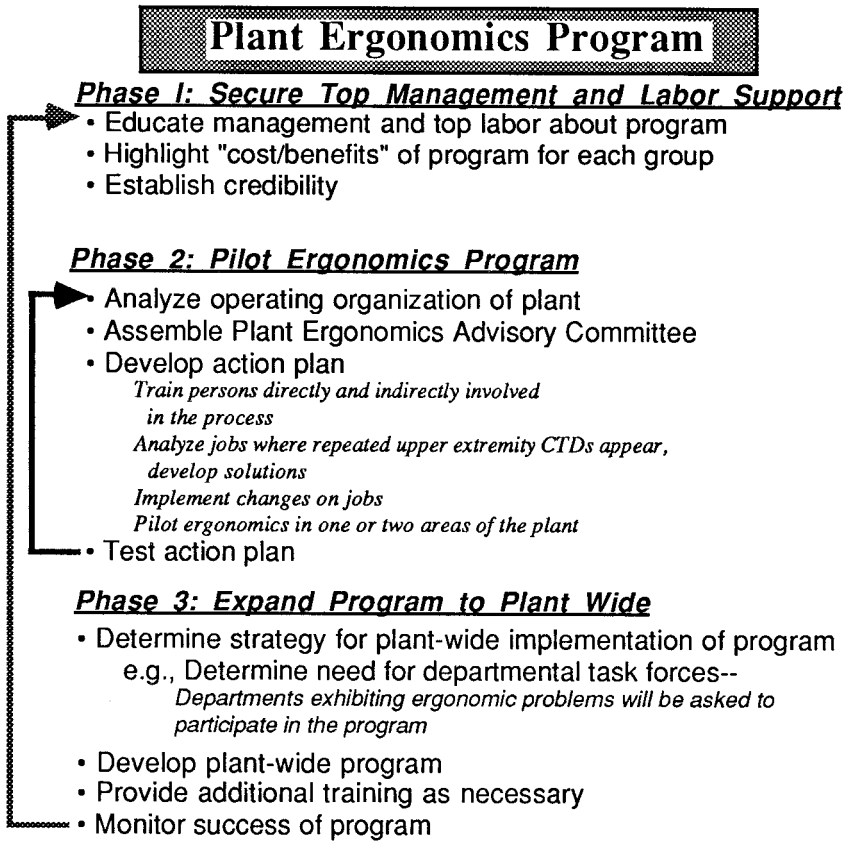

FIGURE 12.3 Ergonomics process flow chart.

demonstrate that the problems are real and widespread. The use of an in-house expert or outside consultant is helpful in conducting these case studies.

The presentation to plant management and labor representatives must be designed to demonstrate the "costs and benefits" of the programs and to highlight areas that positively affect each group's self-interest. This task is relatively easy for an ergonomics program because all parties stand to benefit.

Dollar costs are those that affect the bottom line of the plant. They can be assessed through the use of traditional accounting techniques and cost/benefit analysis. For example, successful implementation of proper ergonomic design may reduce the number of injuries and costs associated with them, while increasing quality and productivity. Simple rate-of-return charts can be used to demonstrate these costs. An example of a rate of return chart is shown in Figure 12.4. With this chart, an experienced person, knowing the cost of poor job design and the associated plant profitability margin, can show the sales necessary to offset the costs.

Emphasis must also be placed on "people benefits." These include reductions in injury prevalence and increases in employee job satisfaction. Accurate records for employee injuries and worker satisfaction are often difficult to obtain, but are important assets to the success of the program.

Step 2: Pilot ergonomics program — Only after top management and labor support have been granted should you proceed to the Step 2. Often this support is conditional — they will want to review the results of the program after a trial period. In order to perform this step, several activities must be initiated.

First, a thorough study of the plant's organizational structure must be done. Typically, a manufacturing plant has a bipartite structure: production and support. Production's purpose is to produce whatever the plant sells. Support's purpose is to provide the expertise and facilities to ensure a smooth production

Rate of Return Calculation for Health and Safety

Accident Costs (Dollars)	<i>Company Profit Margin</i>				
	2%	4%	6%	8%	10%
\$50,000	2,500,000	1,250,000	833,000	625,000	500,000
\$100,000	5,000,000	2,500,000	1,667,000	1,250,000	1,000,000
\$250,000	12,500,000	6,250,000	4,167,000	3,125,000	2,500,000
\$500,000	25,000,000	12,500,000	8,333,000	6,250,000	5,000,000
\$1 Million	50,000,000	25,000,000	16,667,000	12,500,000	10,000,000
\$10 Million	500,000,000	250,000,000	166,667,000	125,000,000	100,000,000
\$20 Million	1,000,000,000	500,000,000	333,333,000	250,000,000	200,000,000

Sales Necessary to Offset the Cost of Injuries at Different Profit Margins

FIGURE 12.4 Rate-of-return table.

process. Some plants are highly automated, and have few production personnel but a large support function. Figure 12.5 shows the operational organization of a large automotive assembly plant.

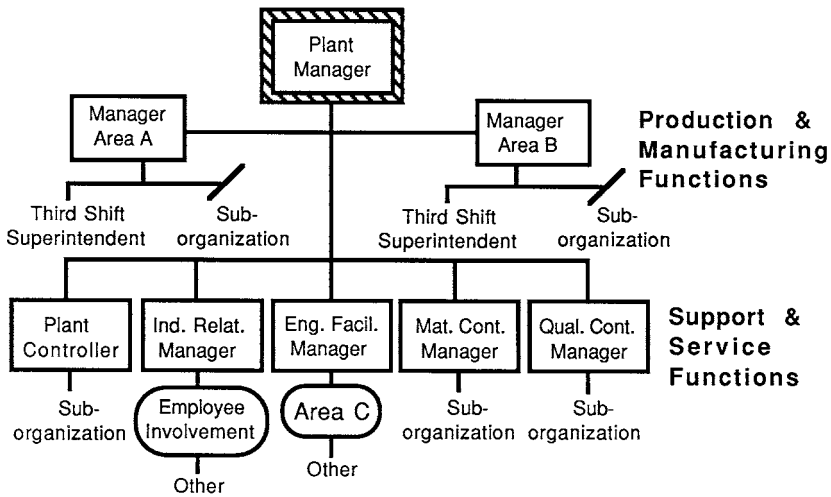

FIGURE 12.5 Functional operating organization of a large industrial facility.

Second, a team must be assembled to form the plant ergonomics committee. The members should be selected by high-level management and union representatives. These leaders should also be represented on the team or be closely associated with it. This support helps to ensure the timely implementation of ergonomic improvements. A letter, signed by these leaders and sent to the appointed individuals and their supervisors, helps to reinforce support for the program.

One criterion for membership should be a familiarity with the plant's culture, since this will ease the team's way in getting things done. Because of the interdisciplinary nature of ergonomics, the committee should consist of people responsible for:

- Identifying problem jobs (a representative from the medical department)

- Determining job stresses (labor representative from the jobs, engineering representative, health and safety engineer, and union health and safety representative)
- Developing solutions (process engineers, manufacturing engineers, maintenance)
- Implementing change (maintenance, industrial engineering, labor representative)
- Follow-up (medical department, etc.)
- Facilitating meetings (a facilitator or group leader to organize meetings and document changes)

A possible list of candidates for a plant ergonomics committee are:

- Industrial Relations Manager or Plant Manager
- Union chairperson
- Plant safety engineer
- Union health and safety representative
- Process engineering supervisor, industrial engineering supervisor, or manufacturing engineering supervisor
- Maintenance supervisor
- Union committee representative from each of the plant area units or departments
- Hospital representative

Third, participants should be trained in the basics of ergonomics. Different levels of training will be required by different people associated with the program. See section on *Training Needs*, below.

Fourth, the program concept must be introduced and piloted in one or two representative areas of the plant. This start-up phase is extremely important for the long-term success of the program. In this phase, management and union support for the program is confirmed. Although the initial step was to gain verbal support for the program, this phase actually secures their long-term commitment, which is necessary for the expansion of the program throughout the plant. Action plans are developed stipulating the “rules and regulations” under which the program will run. These rules may be changed several times before they are agreed upon by all interested parties. If this phase is not properly nurtured, the program may never mature.

Figure 12.6 shows an action plan used by a successful ergonomics program in a manufacturing facility. This action plan includes global issues that specifically affect the operating procedures of the program. Note that the action plan addresses issues for *existing* and *new* projects, as well as for the *people* of the plant.

Step 3: Expand the program plant-wide — It is important that before implementing the program plant-wide, the start-up and pilot phases be given adequate time and resources for the various components to mature. Often, false starts during the start-up phase will necessitate the revision of the rules and regulations. Management and labor support will have to be reinforced. Implementing a plant-wide program during one of these false starts can cause a severe and possibly fatal set-back.

The right time and method for expanding the program to the entire plant will vary, depending on the plant organization, culture, union/management relationship, etc. However, the expansion may involve the development of area ergonomics committees assigned to particular areas of the plant. These area committees may be organized around departments that manufacture and assemble unique products (e.g., building a line of gauges for a particular vehicle) or around areas in the plant that perform a specific set of operations as a subset of the entire assembly and manufacturing process (e.g., the body shop, paint shop, and the trim department of a large auto assembly plant). Because each plant area involves different ergonomic stresses, these teams can concentrate their efforts on identifying their unique problems and developing solutions.

It is often necessary to develop separate guidelines under which each team operates. These guidelines help define the scope of each team’s responsibilities as well as outlining the way the program operates. These guidelines, together with the plant action plan, will help resolve questionable issues. The guidelines must outline when an ergonomics problem will be reviewed by the committee, methods used to evaluate the job, and actions taken (including time limits) for problem resolution.

Action Plan

Organization

The Ergonomics Organization will consist of an Area Ergonomics Committee.

Training

Provide education and training to increase ergonomics awareness.

New Projects

All new projects will utilize ergonomic principles and considerations in the design of products, manufacturing and assembly processes, and equipment.

Existing Projects

Based on medical data, safety considerations, or employee responses, existing processes identified as ergonomically stressful will be reviewed for ergonomic problems and improved

People

Employees exhibiting the effects of ergonomic problems in their work will be encouraged to identify those problems to the ergonomics task force and participate in their solution.

FIGURE 12.6 Ergonomics action plan from manufacturing facility.

Figure 12.7 and 12.8 display two ergonomics programs in large industrial plants. Note that both plants decided to expand their programs to the area levels. In the assembly plant, the expansion involved forming departmental ergonomics committees; in the manufacturing facility, where different processes are needed to make a single product, ergonomics committees were formed in each of the seven manufacturing areas.

The composition of area committees depends on the size of the respective areas. Typically, a member of supervision, the union committee person, a maintenance person associated with the job, and several hourly employees are associated with such committees.

Training Needs for a Plant Ergonomics Program

One of the significant barriers to the successful implementation of plant ergonomics programs is a lack of ergonomic knowledge. Studies (Joseph, 1986) indicate that training can increase the ergonomics knowledge of all participants, regardless of education level or job status. The nature of the training program depends on the needs of the plant. In general, it is suggested that at least two levels of training be used — awareness training and expert training.

Awareness Training

The basic purpose of the awareness training is to make plant persons familiar with the program and to get buy-in from key members of the plant staff. This buy-in is essential in launching and sustaining ergonomics programs. Training should be short, less than two hours, and should be designed to give participants a basic understanding of the principles of ergonomics, an outline of methodologies for identifying job stresses, and an overview of alternative solutions. In addition, this training should address the procedure by which the ergonomics program and its organization will function within the plant

Organization

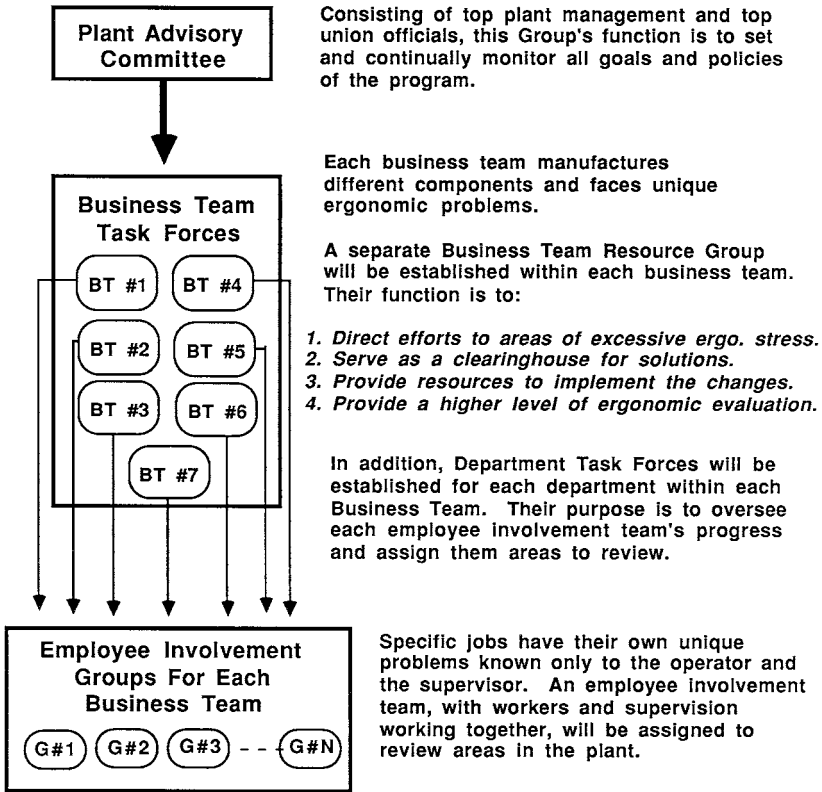

FIGURE 12.7 Ergonomics organization for a manufacturing plant.

organization. Training should be made available to everyone in the plant to make them aware of the efforts being undertaken. In particular, management personnel responsible for implementing and paying for projects, and union representatives responsible for securing worker buy-in to the program should receive awareness training.

Expert Training

The expert training should be designed to give participants the necessary skills to understand the theory behind an ergonomic problem, the procedures for job analysis, the problem-solving skills to correct job stresses, and methodologies to evaluate the solution. All members of the ergonomics committee should receive this training.

This training may be further divided into two categories:

- *General introductory training* — which covers a broad range of topics
- *Special topic training* — which focuses on one or two special topics in ergonomics that are necessary for risk factor analysis and correction of job stresses

The length of the *general introductory* training can vary between a day and a week, depending on the number of topics covered. Regardless of length, the training should combine both lecture-based and hands-on sessions. The contents should include at least the following components:

1. Introduction and General Principles — A short session on general ergonomic principles, including an explanation of the theoretical man-machine interface. Often these principles are demonstrated

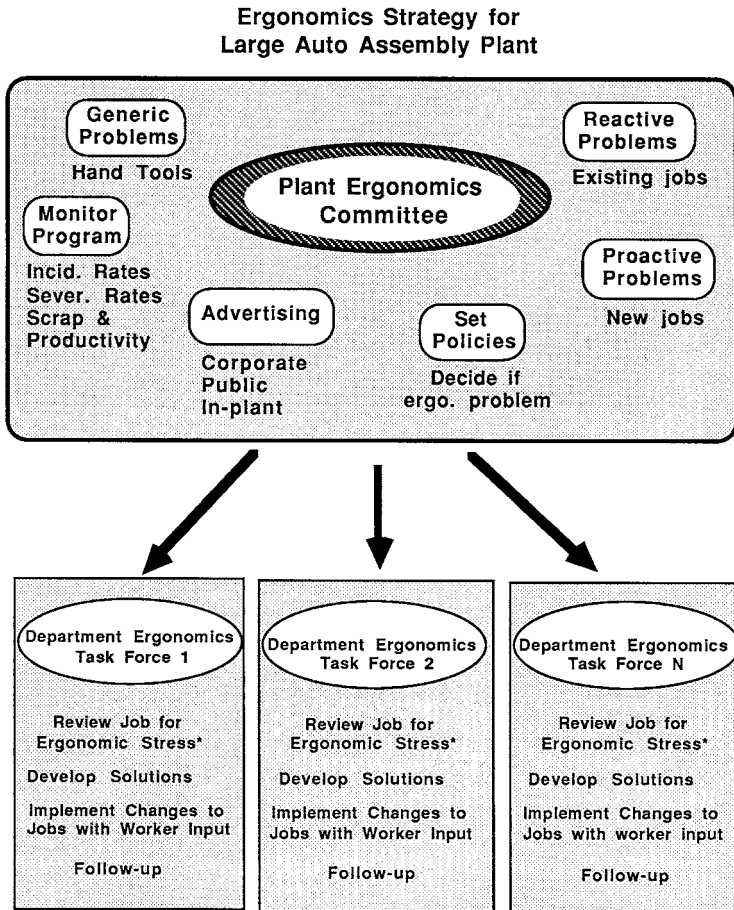

* Target jobs can be chosen based on operator complaints, plant ergonomic, committee recommendations, hospital records, etc.

FIGURE 12.8 Ergonomics organization for a large auto assembly plant.

by defining the man-machine interface, the components that make up the interface, and the consequences of poor design.

2. Risk Factors in Poor Job Design — A session on specific problems associated with poor ergonomic design. Generally, four types of problems are highlighted, along with their associated risk factors:
 1. Upper extremity cumulative trauma disorders, including localized fatigue, shoulder, hand, and wrist disorders, etc.
 2. Manual material handling, including problems with lifting, whole-body fatigue, heat stress, etc.
 3. Controls, displays and information processing problems, including problems with machine repair, quality control, etc.
 4. General considerations in workplace design and layout, including problems with lighting, seating, etc.
3. Job Analysis and Solutions — A session on methods to use in assessing ergonomic stresses, and on developing solutions. Obviously, the introductory level of training will not teach sophisticated job analysis techniques. Instead, it should equip committee members to analyze jobs for basic ergonomic stress. The results of this analysis can often be used to reduce the exposures. However, the training should also emphasize that, in some cases, more sophisticated job analysis techniques will be necessary, requiring the assistance of in-house or outside experts.

4. Hands-on — The final session should be devoted to hands-on exercises. Participants should have practice analyzing jobs, determining exposures, and developing solutions. These solutions should be discussed with the other participants in the classroom. This portion of the training can be supplemented with videotapes or job-site visits.

The *special topics* portion of expert training should be designed to teach participants advanced job analysis techniques. It should include workshops for individuals in the program who have very specialized tasks — for example, the medical persons in charge of medical surveillance may need training in record-keeping techniques.

It is recommended that this training be given to committee members who require special skills and who are in charge of implementing and fitting the changes onto the shop floor. This includes the practitioners in the program who will have direct responsibility for analyzing jobs and developing solutions (e.g., engineers, etc.).

In all levels of training, it should be emphasized that ergonomics is a broad-based science requiring a team approach to identify and fix problem jobs.

12.4 Recommended Methods of Data Collection

Whenever a health and safety program (or any program) is implemented in the plant, constant feedback is essential. This feedback helps participants to determine the success of the program in accomplishing its goals. Data collection should begin as early as possible during the start-up phase because the results can help management decide how and when to begin plant-wide implementation of the program.

Data collection methods need to be compatible with the plant's operating procedures in order to minimize the resistance to change so often encountered. In some cases, existing data collection methods can be adapted for the requirements of the project, thus obviating the need to invent new ones. However, any method used in the data collection process has to be reviewed, and possibly changed, to ensure that it suits both the plant's system and the needs of ergonomic recordkeeping.

There are two important areas of data collection that should be studied to accurately assess a program. They are Process and Outcomes measures.

Proposed Methods of Data Collection

Accurate and complete data collection is essential to the success of an ergonomics program, both to ensure that efforts to reduce injuries and illnesses are working, and to demonstrate this success to a facility's decision makers. This is especially true in large organizations where "corporate management" is often removed from the daily operations.

Data should be collected in two areas: Process measures and outcome measures. A process measures determines if the system is performing properly. It evaluates systems and organizations to determine if they are doing what they are supposed to be doing. Outcome measures determine if the process is delivering the correct product to the customer. In the case of ergonomics programs, at least two different measures should be used — medical and intervention information.

Medical data: Medical reporting and recording systems in most industrial plants are inadequate for the purposes of effective ergonomics data collection. For the purpose of identifying problem jobs, the chief weakness of the system is the difficulty of tracing a particular injury to a particular job. Another problem is that the nature of ergonomics-related injuries and illnesses makes "early detection" difficult. It is almost impossible, in the present state of affairs, to assess the real number of work-related injuries and illnesses.

It is recommended that existing medical data collection be supplemented by active surveillance (diagnostic examinations and self-administered questionnaires are discussed) and by the use of other data sources, such as job process sheets. It is further recommended that medical costs be more accurately tracked through the use of a relational database system for the recording of medical visits.

The report reviews the sources currently available which reflect operational changes due to ergonomic improvements. Suggestions are made for recommendations in procedures for collecting the following data:

- Absenteeism
- Scrap/quality measurables
- Productivity
- Worker satisfaction
- Reductions in known risk factors for ergonomics-related injuries

Intervention costs: The report discusses the need for and the difficulties in securing accurate cost/benefit information for ergonomic changes. Recommendations are made for the development of a form which details the various costs involved in implementing job changes. Such costs should be weighed against the documented reductions in medical and other costs associated with work-related injuries in particular jobs, departments, or areas of the plant.

Data Collection for Medical

One of the primary benefits of health and safety programs is the reduction in job-related injuries. Therefore, the proof of any program's effectiveness depends on a demonstration that injuries and the associated costs have declined. Evaluating the effectiveness of an ergonomics program means showing that injuries and medical costs have gone down for jobs or areas where ergonomic improvements have been made. The present medical recording system makes this task very difficult. In many plants, after an employee develops a medical condition, the procedure works as follows:

- Step 1. Employee reports a medical problem in four different ways:
 - a. Reports to foreman and gets permission to go to medical.
 - b. Goes straight to Emergency Room of affiliated hospital.
 - c. Reports to main hospital next day before shift.
 - d. Reports problem to family doctor — If the doctor judges it to be work-related, then the employee will usually report the problem to plant medical within a few working days.
- Step 2. Plant hospital case history or equivalent — Once the employee reports the problem to the medical department, a case history report or equivalent is filled out. Typically, this form has two sides or has multiple pages. On one of the additional pages or the back side of the form is information about the injury itself and any follow-up notes concerning the progress of the injury and the employee's recovery. On the front side of the form is information that identifies the employee by his/her name, social security/employee number, home address, telephone number, sex, age, shift, plant department number, date/time of injury, date/time injury reported, cause of accident/injury, the job classification at time of injury, and injury/illness code. In some cases, these reports will include a statement from the employee as to the cause of the incident, including a description of how it occurred.
- Step 3. Depending on the severity of the case an accident investigation may be done. This investigation often has two parts — one done by the supervisor and another by the safety engineer. The purpose of this report is to determine exactly how the incident occurred and what corrective actions are being taken to prevent further occurrences. If the case results in lost or restricted workdays, then the number of days will be recorded.
- Step 4. Application for compensation and lost time — If the injury is sufficiently severe to require medical attention beyond initial treatment at the medical office, or if the injury prevents the employee from performing normal work duties, then the employee can apply for workers' compensation. Depending on the state and the rules, compensation for specific types of injuries may be available. Usually every claim must be reviewed by the plant compensation office before being accepted or rejected by workers' compensation. Often workers' compensation records only the most severe cases and does not provide an accurate picture of the true incidence of illness or injury in a plant.

This medical recording system is often called passive surveillance. It has a number of weaknesses for use as a basis for evaluating ergonomics programs.

First, the system is not designed to associate a specific injury with a specific job. Instead, it provides a picture of “global” trends of injury for large areas of the plant. This picture makes it possible to evaluate the overall effectiveness of health and safety efforts, and to pinpoint large “hot spots” where further attention is needed. But because one cannot use the data to relate the incidence of injuries to specific jobs, its value for use in cost analysis of ergonomic improvements is limited.

Second, passive surveillance systems alone, or analysis of existing medical records, may not indicate the extent of injury. Cumulative trauma disorders and related musculoskeletal disorders often have nonspecific symptoms that occur after hours and on weekends. Employees often do not relate these symptoms to the job and do not seek medical attention until after the symptoms have progressed enough to hamper their work efforts. Often these late-stage cases indicate only the tip of the iceberg of job effects.

For every compensable case, there are many more cases of employees with subclinical complaints. Consequently, OSHA logs and workers’ compensation data often identify late-stage (tip of iceberg) disorders and complaints, reflecting only a subset of the population afflicted by these disorders. However, the plant medical case reports may be useful as an early indicator of medical incidents. Because these reports are filled out for all cases other than simple first aid, they can give a more accurate indication of the number of work-related injuries and illnesses in the plant. Still, the accuracy of these records depends on many uncontrollable factors.

Third, the period elapsing from the time when the operator notices the initial symptoms of the injury and when he seeks medical attention often is lengthy, and the employee may have moved to a new department or job. Consequently, it is hard to pinpoint the job that caused the injury or to correlate the job type with specific injury type.

Fourth, passive surveillance systems depend on the employee to report the injury to the plant medical department. If employees are not knowledgeable about the symptoms and do not associate them with their work activity, or if employees do not have a good relationship with the plant medical department, they may neglect to report them. This can result in an under-estimation of the numbers of work-related injuries in the plant.

Fifth, the use of medical records in passive surveillance systems may hamper the participative approach since only certain personnel have access to them.

An alternative method for determining the extent of work-related injuries is active surveillance. Active surveillance can be done in a number of ways, of which two are discussed here.

One method involves noninvasive diagnostic examinations by trained medical professionals. The examinations are designed to detect symptoms of cumulative trauma disorders and other ergonomics-related injuries. Although accurate, this method is expensive and inconvenient. The employee must be off the job for the period of the examination. Furthermore, it requires the services of trained medical specialists.

The other method uses self-administered questionnaires. The main advantage of this method is that it is inexpensive. The employee can fill out the questionnaire on his or her own time. No special personnel are required to administer or interpret the results. However, the questionnaires are probably not as reliable as the examinations in producing data about subclinical cases. Furthermore, the success of the program depends on the timeliness and accuracy with which the questionnaires are completed and returned.

The best strategy is to combine these two methods. For example, one approach is to administer the questionnaire to all employees, and then, based on their responses, to select a subset of employees who have a high probability of disease. These employees are then examined by medical specialists in order to confirm the diagnosis.

As one might suspect, even though active surveillance systems are more accurate than passive surveillance, they can be costly to administer. In addition, they are time consuming and may disrupt normal plant operations. Therefore, even if the resources are available to conduct active surveillance properly (e.g., a well-trained staff, arrangements for workers to be off the job for up to an hour), it should be used with discretion.

Because of the complications involved in establishing an active surveillance method for ergonomics, it is often desirable, at least initially, to adapt the plant's existing system. Typically, the information in the existing plant medical system is sufficient for the current needs of the medical department and any reports they have to generate. However, for evaluation purposes, there needs to be a way to identify the individual job. One cannot simply develop a new medical recordkeeping system without adequate support from the medical department, plant management, and the corporation. This support can take months or years to gain, and once there, the system itself can take longer to implement. In the meantime, it is proposed that modifications should be made to the current system.

Because of the availability of the plant case history report and the frequency with which it is used, most modifications should be tied to this report. These modifications should help link reported injuries to specific jobs, and they should include at least the following information. Below is a summary of proposed modifications.

1. *Job identification system* — Most plants have a structure for dividing up responsibilities on the production floor. Typically, this structure has at least three levels: superintendent, general supervisor, and supervisor. The superintendent has responsibility for all the general supervisors in a particular area, which is defined by various factors such as similarity of products or operations. A general supervisor controls several supervisors, each of whom oversees from 20 to 30 operators. Therefore, a method should be developed to match a particular employee to a specific supervisor so that a medical incident can be tied to 1 of 20 jobs.

It should be noted that a mechanism already exists in most plants to help identify specific jobs — namely, the job process sheets completed by the plant engineers. These sheets are typically developed and maintained by industrial and process engineering. They outline the specific tasks the operator must go through to complete the job. All jobs have a unique sheet.

2. *Medical cost system* — There are several costs associated with a medical incident, whether it involves a single medical visit or lost-time compensation. The cost of a medical visit includes the time away from the job, the time for the doctor or nurse to make an examination, treatment time, and materials associated with treatment. (In fact, some studies estimate that medical visit costs may average \$50.) These costs should be recorded, on existing medical record forms, along with the major costs associated with workers' compensation, days restricted, or days lost from work.

Because of the nature of these injuries, it is important to use "relational" database systems. Many of the larger database systems used in corporations (payroll, workers' compensation) are relational. A relational database is very powerful and allows one to record multiple injuries for a single individual. These injuries may be differentiated by time of occurrence or by body location. Whichever is the case, accurate records of the data can only be done efficiently if the data collection system relates each incident of an indicator to a common denominator. These denominators can either be the person or the job the person is working on. (In many cases, it is both.) A relational database system can record such data properly.

Figure 12.9 depicts the logic of a simple relational database that can be used for recording medical records. There are two components — employee information and injury data. For each employee, demographic information identifying the employee and worker number are recorded to identify exactly who the injured is and where he/she was working at the time of injury. For each injury (there may be more than one injury for each employee), the type of injury, the location of the job at the time of injury, the date of the injury, and the cost of immediate medical attention can be recorded. If the employee receives lost time or restriction, then the employee number can be used to access an existing medical records management system.

Success in using the modified medical records system depends on certain characteristics of the plant. First, it is necessary that the project be implemented in a plant where the medical department and the employees have a good relationship, and where they are aware of and sensitive to the symptoms and causes of CTDs and low back pain.

Second, only plants located where the workers' compensation system recognizes that CTDs and low back pain can be work-related can employ this modified system. For example, in the state of Ohio,

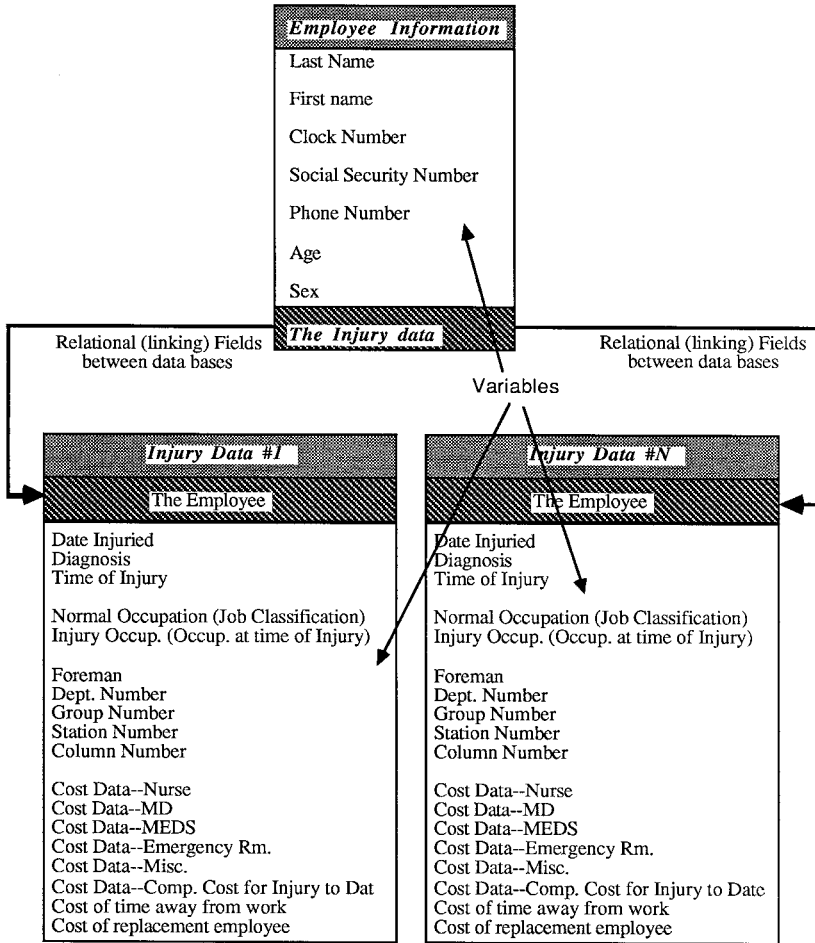

FIGURE 12.9 Database logic for personal computer-based medical records analysis system.

because of a recent state Supreme Court ruling in favor of allowing workers' compensation for CTDs, employers and employees alike are keenly aware of the problem. Consequently, they are reporting the problems earlier to the medical department.

Data Collection for Outcomes of Ergonomics Projects That Benefit the Plant

In order to determine whether ergonomic improvements have the desired effect, it is essential to record before and after measurements of certain operational variables of the job. Desired effects include:

- Lower absenteeism rates
- Reduction in errors and scrap (quality measurables)
- Improved productivity
- Greater job satisfaction
- Reduction in known risk factors leading to musculoskeletal disorders

Analysis of all these variables should be done as a part of the job analysis, and again later as a part of project evaluation.

The current sources for this information in most manufacturing facilities are as follows:

1. *Absenteeism.* Absenteeism records are typically kept for each department by the foreman. These records are sent to the personnel office and recorded.
2. *Scrap/Quality.* Scrap rates are kept for each operation. A scrap budget is set, by operation, for each department. This scrap rate is standardized by comparing it to the number of vehicles assembled.
3. *Productivity.* Productivity rates are determined by traditional time study procedures. The plant operates at a specific rate, expressed in the number of units per hour. These rates are changed only after engineering has made a process change that warrants a reevaluation of the time standard.
4. *Worker Satisfaction.* In many plants, no data are *routinely* collected.
5. *Reduction in the Risk Factors Contributing to CTDs and Low-Back Pain.* No data are routinely collected.

Data for scrap rates, quality rates, and productivity are currently collected in most industrial plants. However, the data are usually collected by department and sent to a central processing area to be summarized. This makes it difficult to associate the data with a particular job change. In addition, data on worker satisfaction and ergonomic risk factors are not currently collected in most plants. These data need to be collected before and after job changes to determine if the projects are reducing exposures to known risk factors.

In all cases, current operating procedures should be maintained. Any new collection systems should be developed to work within the existing systems. With this in mind, it is proposed that the following changes be made to the existing databases or other data collecting mechanism in order to facilitate data collection. A form should be developed to record and compare the data before and after projects have been implemented on the floor. Every entry onto the form should record the department and specific job location.

1. *Absenteeism.* Current operating procedures should be maintained. A copy of the data should be intercepted and entered into the project database for analysis by department and, if possible, by job.
2. *Scrap/Quality.* The ergonomics task force should devise a new form to keep track of scrap and quality measurements, by department and by job, and to determine improvements on jobs changed by the ergonomics committee. Since plants measure quality in different ways, a QC inspector should be assigned to the team to help with the data collection.
3. *Productivity.* Current operating procedures should be maintained. The industrial engineering process studies and process sheets should be used. A copy of these data should be intercepted and entered into the project database, by department and, if possible, by job before and after job changes.
4. *Worker Satisfaction.* Worker satisfaction may give an indication of the success of the job change since ergonomics is a tool to improve the quality of worklife. The ergonomics task force should devise a form that assesses participant satisfaction in the program. This form may be modeled after one used by Bradley Joseph in his study of an ergonomics program in an automotive plant.
5. *Reduction in the Risk Factors Contributing to CTDs and Low-Back Pain.* This information will be reflected in the data collection for medical because job improvements should show a related reduction in the medical incidence rates. However, because of the nature of these injuries and the time it takes for them to develop, this information may take months or years to collect. Therefore, in the meantime, it is important to keep accurate records on changes, by department and by job. A standardized job analysis system should be developed using existing technology. For example, the NIOSH Work Practices Guide and the University of Michigan Static Strength Model can assess many of the risk factors associated with low back pain. These instruments can be used together to analyze stresses to the low back and determine the static strength requirements of the job.

Analysis of the risk factors for upper extremity cumulative trauma disorders can be done in a variety of ways. However, an economical and convenient way uses a checklist approach that assesses the repetitiveness and postural requirements of the job. The forcefulness of the job is more difficult to assess without the aid of electronic equipment. In addition, ongoing research is being conducted that may lend insight into estimating force through the measurement of several simple variables.

If this research is not available at the time of the study, an estimation of force can still be made by comparing the EMG values to several known forces and stating if it is above or below the known level.

Finally, it is proposed that several characteristics of the job before and after the changes are made will be recorded on paper and videotaped for archival purposes, for further analysis when new risk information becomes available, and for use in the estimation of other risk factors, including force.

Data Collection for Intervention Costs

Interventions or job changes represent a major cost of any ergonomics program. Often, before management will allow the installation of any new project, it has to be cost-justified. Therefore, since cost justification of projects can often decide their fate, it is important that these costs be monitored during the program. In most plants, the current procedure for implementing a project is as follows:

Step 1. Write up proposal — At this stage, the project specifications are developed and summarized through engineering on a project form. A cost justification (cost analysis) statement is attached that allows the decision-makers to determine if the costs of the project will justify the benefits — projects often have to be justified on the basis of traditional cost/benefit analysis and computed in terms of productivity and completed pieces per hour rather than in terms of health and safety costs (see discussion below).

Step 2. Approval of the project — There are two stages in this step.

Stage 1: Corporate approval — Depending on the estimated cost of the project, engineering and other approval have to be obtained either at the corporate level or at the plant level. For example, some plants specify a dollar value cutoff above which the project must be approved by the corporation, and below which the project must be approved through normal plant channels. If a project requires corporate approval, then the corporation pays for the project. However, if a project does not require corporate approval, then the project must be paid through existing plant resources. Projects requiring corporate approval must also go through plant approval.

Stage 2: Plant approval — If necessary, and once approval has been obtained from the corporate engineering functions, the project must also be approved through various plant functions. The director of manufacturing at the plant, industrial engineering or equivalent, and the controller's office must all approve the project.

Regardless of the stage, the project form is sent through proper channels for approval. If approved, the responsible supervisor signs the form and retains a copy.

Step 3. Purchasing — The purchasing department sends the completed project out for bids.

Step 4. Vendors bid on project — Usually the lowest bid with the highest quality wins the bid and builds the project. It should be noted that this step may be omitted if the work is done in-house.

Step 5. Installation of project — The project may be installed with existing plant resources or, in special cases, with contracted professional services.

Step 6. Payment for project — Depending on the costs, either the corporation or the plant pays for the completed project.

Intervention costs can be assessed through normal operating procedures. If the project is approved, the project form should be copied by a member of the plant ergonomics team (and the departmental task force, if there is one). This information will be useful in determining the direct costs (materials, design time, etc.) to implement the job changes.

Problems with Cost/Benefit Analysis for Ergonomics Projects

Currently, as in most manufacturing facilities and depending on the costs, all business projects must go through normal purchasing channels to be approved for funding (see above discussion). Unless costs are nominal, these projects must be reviewed for cost/benefits. Funding is awarded based on traditional cost/benefit analysis calculations and expected savings due to work standards, work practices, or quality.

Below is a list of some of the costs involved in installing new equipment. All these costs should be considered in order to determine accurately the costs of implementing ergonomics projects and changes on the plant floor. It is recommended that a form be developed that records these costs for later analysis.

1. *Design time* — The time and resources involved in designing projects.
2. *Engineering time* — The time and resources involved in engineering the project.
3. *Tool change* — The fabrication costs and time necessary to fabricate a set of tools for the project.
4. *Skilled trades time* — Manpower needs for installing, testing, and maintaining the projects.
5. *Materials* — Cost of materials for the new project.
6. *Machine down time* — If the project is going to directly affect an existing line, that line may have to schedule down time to properly install the project. Therefore, down time and lost production must be budgeted into the installation costs.
7. *Training* — When new equipment and/or processes are implemented on the plant floor, operators responsible for running and maintaining the equipment must receive training.

It may be difficult to use traditional cost systems to justify an ergonomics project. This is because ergonomics projects often do not show significant savings, in the traditional sense, immediately after installation. Instead, the type of savings often seen in ergonomic projects are reductions in health care costs. These are often difficult to justify when the relationship between injuries and the responsible jobs is not well established (see above section).

This lack of an obvious link between an injury and a job yields two results: First, medical costs associated with worker accidents and chronic musculoskeletal disorders are usually not charged directly to the production department responsible for causing the injury. Instead, they are charged to a separate central account in the plant's Industrial Relations Department (or equivalent), thereby partitioning the true costs over the entire plant. This makes it difficult to justify a job change because the benefits are hidden. Consequently, projects often have to be justified on the basis of traditional cost/benefit analysis and computed in terms of plant-wide and area productivity (e.g., or completed pieces per hour). Projects that cannot show a cost/benefit advantage based on these measures often have little chance of implementation.

The second result of the absence of a known relationship between injuries and the production department deals with the poor recording of data. Often, CTDs are recorded only on sickness and absence reports with little or no follow-up. Consequently, employers have little data to go on in establishing a relationship between a job and injury.

Figure 12.10 depicts the relationship between the cost and benefits of ergonomics. Because of the problems of using traditional cost/benefit analysis, it becomes more important to document all the costs associated with poor job design and all the benefits after ergonomic intervention. Therefore, it is often best to make simple, inexpensive changes first. As poorly designed jobs are identified, the data (as outlined above) should be collected and analyzed before and after the proposed job changes. As more data are collected and the cost/benefit equation becomes better defined, it should become less difficult to justify job changes.

12.5 Computers, Internets, and Ergonomic Communication

Introduction

Communication breakdowns between workstation designers and operators has been stated as a barrier to proper ergonomic design. Effective ergonomic programs rely on communication to train the

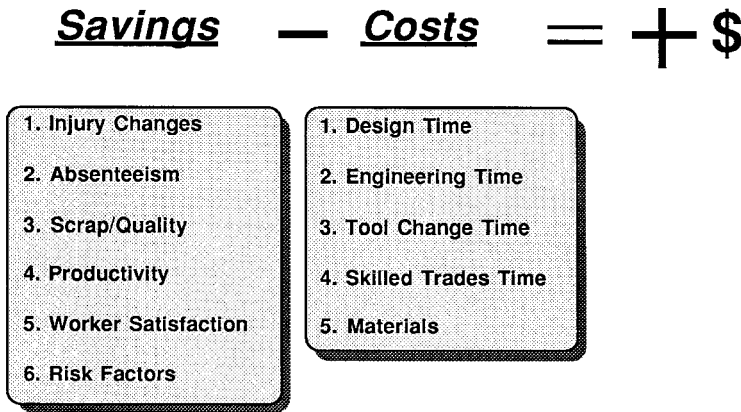

FIGURE 12.10 Cost/benefit summary.

operators to recognize ergonomics problems, provide appropriate measurement systems for detection and remediation, and ensure timely feedback to engineers and designers to ensure that existing problems are not replicated and new designs fully consider ergonomic factors.

This section explores the use of computer technology to overcome communications breakdowns within a plant ergonomics committee and across the entire corporation. Characteristic of participative ergonomics programs which impact communication and the flow of information are presented. Challenges to effectively manage communication throughout corporate ergonomics programs are presented, followed by an approach which uses computer technology to overcome some of these challenges.

Communication and Information Flows

The characteristics of the in-plant ergonomics program discussed in this chapter have several direct implications on the role of communication to ensure its effectiveness. These characteristics include:

- *Monitoring and feedback systems* to track and record injuries, costs, and benefits of job changes
- *Participative teams*, involving representatives from all sectors of the manufacturing and support areas, which are tailored to the existing organizational structures
- *Available training* to attain general and specialized levels of ergonomics expertise among team members

The implications deal with what, to whom, or how ergonomics program information is being communicated. A considerable amount of data must be collected, analyzed, and reviewed to ensure the program is working. Having consistent procedures in place across the organization helps to ensure that plants can talk to other plants and share information, lessons learned, and discuss problems from a common base of understanding. Table 12.1 suggests several implications for effective communication in a corporation-wide ergonomic program.

Gathering and tracking the myriad data needed to support an effective ergonomics program are no small feat. Examples of the types of information flowing through these programs are presented in Table 12.2. All the information is useful within the plant committee to manage the program. Much of these data are also of interest to a broader corporation-wide ergonomics community. This utility is indicated in the table.

The benefits for sharing information across the corporation are significant. Developing effective mechanisms for achieving this is but one challenge to those developing corporate ergonomics programs.

TABLE 12.1 Ergonomics Program Communication Characteristics and Implications

Characteristic	Implication
Monitoring and feedback systems	<p>Process and procedures must be in place to document incidents, causes, solutions, and effectiveness, and report to appropriate communities of interest.</p> <p>Data collection methods must be identified, tested, and implemented within the plant to gather medical, cost intervention, and outcome data.</p> <p>Paper and pencil or automated tracking systems are needed to log incidents, assign responsibility, and track progress.</p> <p>Mechanisms for tracing design issues back to the designer, along with any in-plant solutions and operator feedback must be established.</p>
Participative teams	<p>Mechanisms must be established for selecting team members with an appropriate cross-functional background.</p> <p>Team-building exercises and management commitment documents are encouraged to ensure common goals and objectives are adopted among members from divergent experience and background.</p> <p>Team member rosters must be kept current and include active and adjunct members, and their position on the team as well as contact data.</p>
Available training	<p>Training classes must be made available to all team members to ensure informed participation and common bases for problem solving.</p> <p>Training must be consistent across teams to achieve common understanding.</p>

TABLE 12.2 Ergonomic Process Information and the User Community

Information used by →	In-plant committee	Corporate community
Best Practices	1	1
Case Studies	1	1
Committee Meeting Minutes	1	
Cost data (injury, design solutions)	1	1
Engineering Drawings	1	1
Ergonomic Incidence Logs	1	
Ergonomic Indicators	1	1
Ergonomic Risk factors	1	1
Ergonomic Standards	1	1
Incidence Action Tracking Log	1	
Job/operation codes	1	1
Lessons Learned	1	1
Management commitment documents	1	1
Medical data (visits, case reports)	1	
OSHA Logs	1	1
Part code, characteristics	1	1
Team roster/phone directory	1	1
Training classes, schedules	1	1
Vendor/Supplier data	1	1
Workforce population data	1	1
Workers Compensation data	1	1
Workstation layouts	1	1
Workstation/Ergonomic checklists	1	1

Challenges to Effective Communication

The task of keeping ergonomics programs running smoothly is full of communications challenges. Challenges relevant to the plant-level programs, and those which occur as a result of adopting the program corporation-wide, are discussed.

Setting up in-plant programs clearly must accommodate plant-specific cultures, management styles, and work patterns. Maintaining effective plant programs faces the challenges of:

1. Applying appropriate ergonomics expertise to a broader community of cross-functional team members, with safeguards to prevent misapplication (through training).
2. Effectively supporting an administrative documentation process without burdening committee members.
3. Allowing plant-control of work in progress but providing sufficient corporate oversight to ensure accurate data gathering and consistent process documentation.

All of these challenges pose a manpower resource dilemma for ergonomics programs. Unless the information is captured and documented, the process cannot document its effectiveness. Nor can it provide insights and lessons to use later. The documentation becomes the database. Supporting the documentation process through labor-saving means should become a number-one priority.

As the process is adopted for corporation-wide use, an additional set of challenges surfaces. These include:

1. Providing access to corporate repositories for common data (e.g., manufacturing part information, sanitized workers' compensation costs, approved ergonomic risk factors, etc.).
2. Applying consistency to the ergonomics process to ensure an acceptable level of corporation-wide legal compliance.
3. Providing for informal, risk-free but timely means of communication across committees.
4. Providing means and media to share information on ergonomic best practices, lessons learned, costs, and recurring problems.

The common threads among these challenges seem to be

- Access to data
- Access to people
- Minimize the impact on resources

An effective solution to these challenges must weave these issues together.

Using Computers to Overcome Challenges

The traditional mode of communication employed in participative teams has been face-to-face. The time constraints and geographic dispersion of today's corporate work environment (even for in-plant programs) demand alternative modes of collaboration to achieve effective communication. Just as counterparts in the manufacturing, production, and back-office components of the corporation have adopted computer technology as the means to do more with less, so must the ergonomist employ the computer as a tool to leverage resources effectively.

Experience in developing computer tools for ergonomics processes has taught us several things:

1. The applications must effectively reduce the administrative burden at the plant level first (i.e., the tools must reduce the documentation workload and free the committee for solving ergonomic problems).
2. Users from several local committees must be involved in the design, pilot testing, and fielding to ensure broadest acceptance.
3. The life-cycle costs of fielding, training, distributing, and supporting traditional software applications can far exceed the cost of initial development.
4. Internet technology presents significant advantages for addressing communication challenges and managing application life cycle costs.

Figure 12.11 presents the components for a proven computer-based solution. The approach is based around a centralized ergonomics evidence database application and uses corporate internet technology to support plant access and data exchange.

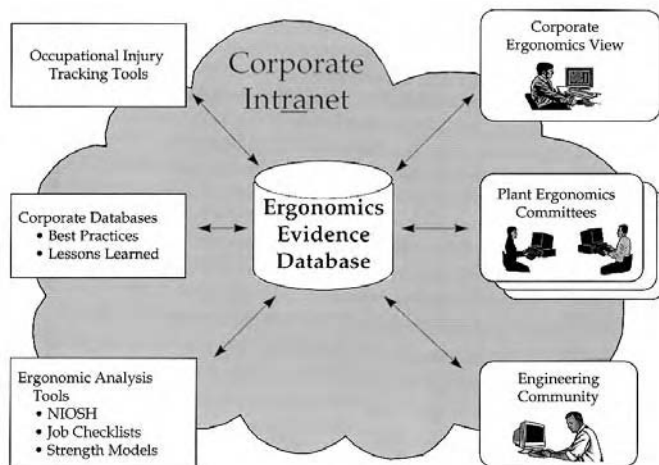

FIGURE 12.11 Components of a computer-assisted solution for ergonomic processes.

The central database allows all plants to read and write to the database as they access and manage their ergonomic documentation data. Data sharing across plants is permitted only at the discretion of the source plant. Once the documentation process is completed for an ergonomics incident, the plant can release the data for corporation-wide viewing.

The Automated Ergonomics Evidence Book (AEEB) uses an advanced Internet browser front end to guide the user through the features and functions of the application. It links all plants to the central database, but maintains plant-level control over documentation in process, builds an electronic ergonomics incident evidence book and easily supports the administrative tasks of maintaining the book, documenting the progress, and generating required and *ad hoc* reports. It also reduces the time spent documenting by sharing common data across reports.

By using a centralized database, data generated by or of use to a corporate audience can be maintained centrally but accessed globally. Corporate commitment documents are updated centrally. Schedules for ergonomic training classes, as well as corporation- or division-wide ergonomics news releases, are maintained in one place, but are accessible for all local committees.

The database application also lets the plants track and maintain their roster of plant committee members. These rosters are viewable by other plants and provide an effective means of connecting one with another. Other electronic communication aids provided by the system are bulletin boards for posting news releases, and discussion databases to share ergonomics problems and solutions over an informal but timely communication channel.

The centralized database also permits corporate oversight through read-only access to plant data. Corporate and division ergonomics personnel can conduct audits of each plant's electronic evidence book remotely. For global corporations, this can reduce travel costs and improve process effectiveness significantly. Spot-audits conducted remotely can permit remedial coaching and process improvement on a more timely basis.

This approach has provided a flexible, accessible, and maintainable solution with key features. These include:

1. Centralized data and software location reduces maintenance and distribution costs as well as simplifying corporate oversight and process audits

2. Leverage of existing corporate intranet technology for data access, distribution, and sharing
3. Enhanced support for communication among diverse corporate groups, including the ergonomics, engineering, and health and safety communities
4. Customized computer support for all the documentation requirements of the established ergonomics process

As the AEEB Internet approach is fielded, new requirements are being added to expand access to a broader range of data sources and user communities. Web-based databases for engineering data, material safety, process descriptions, and personnel rosters are all potential sources which can be accessed through corporate internets.

In addition to corporate web sites, an increasing number of ergonomic sites exist on the World Wide Web. Commercial, government, and professional organizations are employing the WWW to promote data sharing and communication to the widest audience. Jumping on the Web has appeal as a near-term solution to solving the communication and information dilemma. Some degree of corporate ergonomic oversight and control is still advisable to ensure that the information derived from public sites is consistent with the corporate vision or intent.

In order for the ergonomics documentation process to be effective, the data must be accessible and usable by the broadest community. However, the documentation process itself must not be so burdened by recordkeeping that it fails under its own weight. Well-designed computer applications have been proven to be an effective means to the end.

While they may sound obvious, the following lessons bear repeating here:

1. Develop solutions for nontechnical users.
2. Understand the user's requirements thoroughly — this is an ergonomics solution.
3. Realize that local plant committees will not have the high-tech hardware of engineers and designers at their disposal.
4. Develop a single solution with sufficient flexibility to be applicable across the organization.
5. Try to share data from existing corporate databases wherever possible.
6. In the days of global corporations, consider foreign language issues in the interface.
7. Factor the distribution, training, and ongoing support costs into the budget.
8. Dealing with corporate gear-heads presents new challenges!

By employing the power of the Web and corporate Internet resources in developing computer solutions for ergonomics, the challenges of data access, communication, and cost constraints can be effectively managed.

12.6 Lessons Learned

First, it takes a considerable amount of time to start up, pilot, and expand an ergonomics (or any health and safety) program in a large industrial facility. All parties must exercise patience.

Second, the start-up and pilot phase are important steps. Do not attempt to expand the program before these steps have matured.

Third, developing plant monitoring systems is crucial to the cost justification process. Because traditional methods of cost justification do not readily fit ergonomics projects, "cost justification" must be based on other indicators. Proper monitoring can help show how these indicators help in the overall operating efficiency of the plant — people benefits and cost benefits.

Fourth, a plant action plan is very important to develop. Without it, the program will lose focus and direction. This should be jointly developed with management and labor.

Fifth, and most important, top management and top labor support are essential to launch the program. Without this support, the program will have too low a priority to justify participants' time and resources.

Because of competitive pressures and quality specification and because employees are no longer willing to accept the pain and suffering resulting from poorly designed jobs, these and other safety programs

will become the norm rather than the exception. It is hoped that with this report, other plants will develop successful ergonomics programs.

Acknowledgments

The authors would like to thank the American Automobile Manufacturers Association (AAMA) for their support in this effort. The research behind this chapter would have not been possible without the commitment from the plant where the research was done and the support of the AAMA. A list of those who contributed to this effort would be too long to include here, but a special thanks must go to the Plant Safety Supervisor, the Engineering Staff, the workers, and all those individuals and groups that are part of a joint effort. The views, opinions, and conclusions expressed herein are, of course, those of the author and are not necessarily those of the supporting institutions.

References

- Allen, T. *Managing the Flow of Technology*. Cambridge, MA: The MIT Press, 1977.
- Allison, G. *Essence of Decision*. Boston: Little, Brown and Co., 1971.
- Cyert, R. and March, J. *The Behavioral Theory of the Firm*. Englewood Cliffs, NJ: Prentice-Hall, 1963.
- Chaffin, D. and Andersson, G. *Occupational Biomechanics*. New York: John Wiley & Sons, 1984.
- Kanter, R.M. *The Change Masters*. New York: Simon and Schuster, 1983.
- Klein, J.A. Why supervisors resist employee involvement. *Harvard Business Review*, Sept.-Oct. 1984.
- Kochan, T., Dyer, L., and Lipski, D. *The Effectiveness of Union Management Safety and Health Committees*. Michigan: W.E. Upjohn Institute for Employment Research, 1977.
- Koontz, H. and O'Donnell, C. *Principles of Management* (3rd ed.). New York: McGraw-Hill Book Co., 1964.
- Lawler, E., III and Mohrman, S.A. Quality circles after the fad. *Harvard Business Review*, Jan.-Feb., 65-71, 1985.
- March, J. and Simon, H. *Organizations*. New York: John Wiley & Sons, 1958.
- Peters, T. and Waterman, R. *In Search of Excellence: Lessons from America's Best-Run Companies*. New York: Harper and Row, 1982.
- Pfeffer, J. Power and resource allocation in organizations, in *New Directions in Organizational Behavior* (M.B. Straw and G. Salancik, Eds.). Chicago: St. Clair Press, 1977.
- Rohmert, W. Ergonomics and manufacturing industry. *Ergonomics*, 28(8), 1115-1134, 1985.
- Schmidt, S. and Kochan, T. Conflict: toward conceptual clarity. *Administrative Science Quarterly*, 17, 359-370, 1972.
- Shafritz, J.M. and Whitbeck, P.H. *Classics of Organization Theory*. Oak Park, Ill.: Moore Publishing Co., 1-67, 1978.
- Shackel, B. Factors influencing the application of ergonomics in practice. *Ergonomics*, 23(8), 817-820, 1980.
- Tushman, M. and Nadler, D. Implications of political models of organization. Reprinted from *Resource Book in Macro-Organizational Behavior* (R.H. Miles, Ed.). Santa Monica, CA: Goodyear Publishing, 170-190, 1980.
- Vojtecky, M.A. Workplace health education: principles in practice. *Journal of Occupational Medicine*, 27(1), 1985.

13

How to Set Up Ergonomic Processes: A Small-Industry Perspective

13.1	Introduction	13-1
13.2	Definition of Small Business	13-1
13.3	Characteristics of Small Industry	13-2
13.4	Reasons to Implement an Ergonomics Process	13-2
	Competitiveness • Workers' Compensation Costs • Compliance	
13.5	Elements of the Ergonomics Process	13-5
	Choosing the Ergonomics Approach • Process Elements	
13.6	Summary	13-15

Carol Stuart-Buttle
Stuart-Buttle Ergonomics

13.1 Introduction

The ergonomics process for a small business differs from that of a large corporation. The main components of the ergonomics process are similar, but the characteristics and limitations related to the size of a business or industry need to be taken into account. Each of the primary elements of the ergonomics process are discussed in this chapter in terms of the associated difficulties and benefits related to industry size.

Many of the issues raised may pertain to a small plant that is part of a large corporation. The main difference between a small industry and a small facility of a larger entity is the latter usually has a safety and health process defined or mandated at the corporate level. The small facility may turn to the corporation for guidance and information and perhaps assistance and expertise. This chapter focuses on the issues faced by small businesses but does not attempt to contrast these issues with those of large industry.

13.2 Definition of Small Business

Small businesses account for 99.7% of the workplaces in the U.S. and employ 54% of the workforce. About 6.5% of all businesses (20% of the workforce) are in manufacturing, 98.5% of which have less than or equal to 500 employees (7.4% of the workforce) (Armstrong, 1995). The U.S. Small Business Administration (SBA) based the definition of small business on the Standard Industrial Classification (SIC) codes (OMB, 1987), assigning each code in the industry division a maximum number of employees.

Typically, a small business is defined as having less than or equal to 500 employees (SBA, 1993), although a maximum is 1000 employees for a few manufacturing SIC codes (Rose, 1993).

The contribution of small businesses to the overall economy is important. In the U.S., more than half the workforce is employed by small businesses, and since 1989 nearly 100% of new jobs have been created by businesses of less than or equal to five employees (Armstrong, 1995). Small to medium companies are viewed as vitally important to the economic health of other industrialized nations (Wortham, 1994).

13.3 Characteristics of Small Industry

Implementing an ergonomics program and evolving a process are difficult for any company. Large companies meet real-world constraints when establishing a program (Elson, 1994), and small industries have unique characteristics which carry associated constraints. These constraints impact the decisions that are required to develop the best ergonomics program model to fit the culture and business needs of the company. Small industries often have the following characteristics (Stuart-Buttle, 1993):

- *Less formality.* Procedures and communication methods are informal and often have minimal documentation. Teams or task forces are often used but are loosely structured and formed *ad hoc*.
- *Responsibility for several positions.* Personnel perform several job functions, and therefore ergonomics is often included at the same time as addressing other issues. There is reduced team input because there are fewer people in different positions, although the range of perspectives remains.
- *Greater responsiveness.* The company tends to be project based. Therefore, it gives focus to issues and brings them to conclusion.
- *Less specific knowledge.* Having personnel with several job positions means that less time can be spent focused on one specific area such as ergonomics. Therefore, the degree of in-house expertise is usually limited.
- *More management involvement.* Management tends to be involved with the details of plant activities and shows its responsiveness to projects by making decisions and coordinating project efforts. However, the culture of the company also affects the extent of management commitment and employee involvement.
- *Less data-oriented approach.* Once the company has decided on a course of action and is convinced that the approach is a good one, quantification is typically down-played. This reduces the data available for prioritizing problem areas, cost benefit decisions, and determining project effectiveness.

13.4 Reasons to Implement an Ergonomics Process

A productive, competitive business is important for all sizes of business (SBA, 1993). Workers' compensation costs can be a primary drain on a company's productivity. High workplace injuries and illnesses were the reason for the passing of the Occupational Safety and Health Act of 1970 in the U.S. (OSHA, 1970). The Occupational Safety and Health Administration (OSHA) recognized that there were several elements in management practice of safety and health that affected prevention of injuries and illnesses. As a result, OSHA issued management guidelines (OSHA, 1989) and continues to research an ergonomics standard. Some industries, especially small ones, may have lower costs associated with workers' compensation cases, yet their competitiveness may remain suboptimal because the production process is inefficient and potentially unsafe due to poor design. Ergonomics offers more to industry than reduced injuries and illnesses. It is a science that applies knowledge about people to the design of the workplace. When the workplace is designed so that people can perform at their best and machines at their most effective, then productivity is optimized.

Competitiveness

The greatest return from and the prime reason for addressing ergonomics is the increase in the bottom line through production and quality. This may be partly realized by the reduction in workers' compensation and

related costs or by the increase in work by those no longer in discomfort. However, making the job easier for the worker by improving the work layout or reducing rehandling also improves production. According to the government report on the state of small business: “The drive for manufacturing competitiveness in both domestic and overseas markets means that there must be fewer person hours per unit of production” (SBA, 1993, p. 45). Too often operating with fewer workers and automating production are seen as the primary means to increase competitiveness. The effects of automation may not always be positive. Remaining jobs may be more monotonous. Greater skills may be required to interface with the automation and new types of injuries could occur (Järvinen, 1991). This efficiency is best achieved by improving the existing workplace which can generate large production savings (Oxenburgh, 1991).

Quality is part of the productivity equation. If products are reworked or wasted, then the unit cost is increased. Quality is influenced by human performance, and that performance is directly impacted by the design of the job and workplace. Insufficient time to perform the task, unsuitable lighting and environment, and ineffective training are examples of aspects that can affect quality. Excessive reaching and awkward postures increase the time it takes to perform the task, and quality standards may not be met. If a worker begins to fatigue at the task, then he or she will slow down or may be likely to make mistakes, hence affecting quality and production.

“Money signs and hassles are what most small business owners see when you talk about health and safety” (Synergist, 1994). This is a common view, especially when the full cost benefits are not understood or considered when assessing a safety and health problem and the potential solutions. When the only measure of benefit is the return from reduced workers’ compensation costs, the solution may sometimes appear expensive. This may be particularly noticed in a small company with just one or two low-cost medical cases. It is important to consider the full cost benefits of workplace improvement. If the solution or improvement is not cost-effective with a return on investment in a reasonable time frame, then the approach may not be the right one, and an alternative needs to be sought.

Workers’ Compensation Costs

For a number of years there has been a trend across most industry divisions that shows the highest injury incidence rates (per 100 full-time workers) are incurred by establishment sizes of 50 to 249 employees (BLS, 1992, BLS, 1995). Figure 13.13.1 illustrates the injury incidence rates for manufacturing industries by employment size.

Days away from work are particularly expensive to a company. The most common source for injury and illness for lost workday cases in manufacturing was reported to be the “worker motion or position.” Overexertion was the primary event causing injury and illness across all the divisions of industry (Synergist, 1995). Such data strongly suggest the presence of design issues and the job not matching worker capabilities, i.e., poor ergonomics.

Although the national statistics show higher incidence rates for small and medium-sized companies (Figure 13.1), small companies often have only a few cases. This precludes identifying trends and makes it difficult to decide if there is a larger problem. A proactive approach, that is not dependent upon the medical or workers’ compensation data, helps to prevent the company from becoming entangled in such trend debates. Workers’ compensation and the safety and health of the workforce are important, and the jobs associated with the problems should be addressed first.

Lost workdays are expensive for any company, but the burden may be greater on a small industry because there are fewer employees. If an employee serves several job functions, the loss may be even greater. The hidden or indirect costs that go hand in hand with a workplace injury should also be remembered in the cost-benefit equation. Examples of cost include training a temporary replacement, the associated lost production, productive time lost while attending to medical needs, and the time for accident investigation.

Compliance

Compliance to government regulations should not be the sole reason for implementing an ergonomics program. If the workplace is designed well for most people to perform their jobs effectively on a long-term

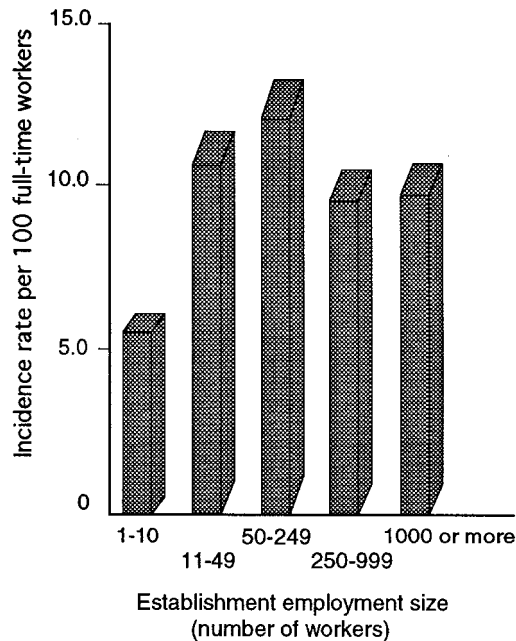

FIGURE 13.1 1994 injury incidence rates by industry employment size for the manufacturing industry division. (Data from Bureau of Labor Statistics (BLS). 1995. Excerpts from annual BLS survey; occupational injuries and illnesses in 1994. *Occupational Safety and Health Reporter*. 12-20-95:1002.)

basis, then the workplace will be safe and healthy. However, there are laws that oblige employers to provide a safe and healthy workplace. In the U.S., the OSH Act of 1970 has a general duty clause (Section 5 (a) (1)) that requires employers to furnish each employee a place of “employment which is free from recognized hazards that are causing or are likely to cause death or serious physical harm” (OSHA, 1970). There are also ergonomics standards that are being developed at federal and state levels that will require compliance. Some guidelines, although not mandated standards, may be used in the future for compliance if they reflect a consensus of best practice. If an ergonomics program is implemented with compliance as the only goal, then redesigns are likely to fall short of the best solutions to the problems and limit the efficiency improvements.

At present, in the U.S. there are no national ergonomics or safety and health program standards; however, there are some guidelines. Many companies have incorporated ergonomics into general safety and health programs following the *Safety and Health Management Guidelines* issued by OSHA in 1989 (OSHA, 1989). The following year OSHA published similar ergonomics program guidelines for meat-packing plants which have since been adopted by other industries (OSHA, 1990). The same basic program components appear in the *OSHA Handbook for Small Businesses* (OSHA, 1992). The Voluntary Protection Program (VPP) is also based on the *Safety and Health Management Guidelines*. A recent survey of 650 companies indicated a 26% decline in workers’ compensation costs, due in part to safety and health programs (BNA, 1996). Companies that have participated in VPP have had on average a 50% drop in workers’ compensation premiums since 1989 (Esposito, 1996). Total quality improvement or management programs incorporate the primary elements encouraged by OSHA in their guidelines (Robinson, 1991). However, the effectiveness of an ergonomics program is dependent on how well it is implemented.

There are some additional guidelines that are being written in the U.S. that may affect how a company addresses ergonomics. The American National Standards Institute (ANSI) is developing a guideline for the control of work-related cumulative trauma disorders (ANSI Z365) (ANSI, 1996). ANSI and The Human Factors and Ergonomics Society are updating the 1988 standard for Human Factors Engineering of Visual Display Terminals (ANSI, 1988).

Other government regulations which require compliance and are related to ergonomics are the laws of Equal Employment Opportunity (EEO) (EEOC, 1964) and the Americans with Disabilities Act (ADA) which falls under the EEO Commission (EEOC, 1990). Many manufacturing tasks are performed by men and are difficult for most women to undertake. However, if a job is improved so that more of the population, including women, can perform it, then costs associated with finding the right people are lowered and compliance with the EEO is not in question. Likewise, if the workplace is designed to accommodate as much of the general population as possible, then specific accommodation for the disabled is easier because the workplace is more flexible. The ADA requires employers to make “reasonable accommodation” for a worker with a disability. During the first 18 months in which the ADA was in effect, about 12,000 charges were filed. Nearly 20% dealt with back ailments (BNA, 1993). When a company develops a culture that attempts to accommodate those with disabilities, it also makes it easier for people to return to work. The company becomes more creative and flexible, so that jobs can be modified allowing injured workers to be reintroduced gradually to a fully productive job (Olsheski, 1996). Therefore, there are many benefits to designing well for a wide sector of the population, so compliance in itself need not be a burden to industry.

13.5 Elements of the Ergonomics Process

To establish an ergonomics process, a program has to be initiated. The process sustains the program using methods such as systematic evaluation and revision based on effectiveness. In the long-term, a program without a process is not successful. The model of the program and the degree of integration into other company processes is dependent upon several factors, such as company size, responsibilities of the personnel, available resources, and the company culture. For success, it is important for a company to find an approach that is the most suitable and effective, rather than to apply a theoretical model that may conflict with the organization’s needs and culture. Whatever the model, the ergonomics program goal remains the same: design the workplace so that it is healthy, safe, and optimally productive.

Choosing the Ergonomics Approach

The primary four elements in the *Safety and Health Management Guidelines* are: management commitment and employee involvement; worksite analysis; hazard prevention and control; and safety and health training (OSHA, 1989). These components are generally considered essential in any approach to ergonomics in industry. Medical management and a written program are elements in the meatpacking guidelines and are often included in companies’ programs (OSHA, 1990). The success of ergonomics in a company remains dependent on how well the program is structured and carried out. A “one size fits all” method does not work when implementing an ergonomics program. A program must be tailored to fit the company culture. The following factors influence the development of a program and should be taken into consideration:

- Size
- Culture
- Resources
- Type of industry
- Types of ergonomics controls implemented
- Compatibility with other programs and processes

A program does not have to reach full integration with other company processes to be successful. The above factors and particularly the characteristics of small industry determine the appropriate extent of integration. If a program is minimally integrated into the company, it is more likely that the program remains driven by reacting to problems and precludes the development of a proactive approach. In other words, job improvements tend to be made in response to problems and not before problems occur. Incorporating ergonomics proactively requires shared responsibility, involvement, and commitment

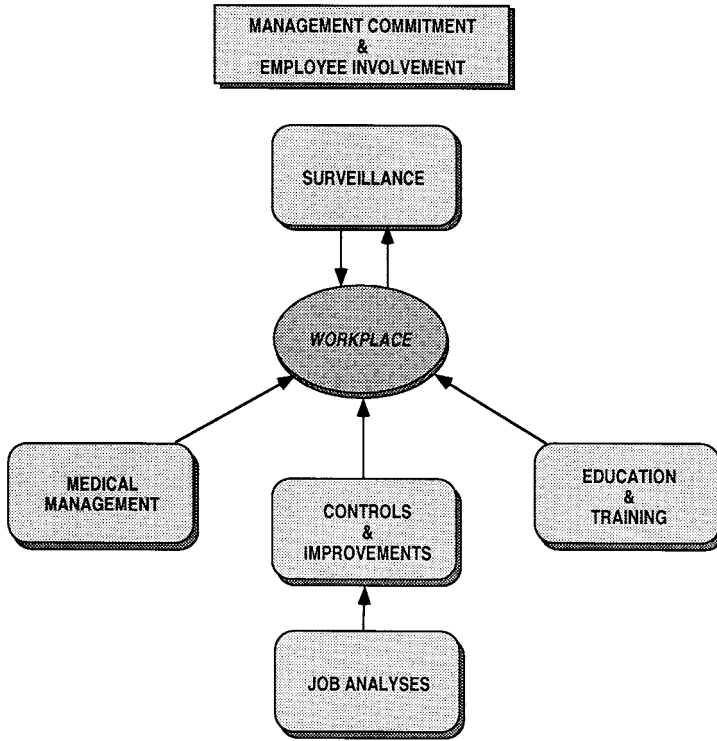

FIGURE 13.2 Diagram of the elements of an ergonomics process.

throughout departments. The more ergonomics becomes part of the company culture, the greater its effectiveness. But it takes time to evolve and integrate a process into a system. An ergonomics process is dynamic, and regular evaluation and revision are necessary to maintain or improve effectiveness.

Process Elements

The elements of an ergonomics process are discussed from the perspective of small business, highlighting the problems and advantages due to size. The order in which the elements are discussed is the recommended order that small industry should follow when establishing their ergonomics programs. To begin with, management commitment and employee involvement is essential for any degree of success with an ergonomics program. If there are many work-related medical cases, establish or enhance medical management because addressing this component early in program development can have a dramatic effect on employees' well-being and workers' compensation costs. Next, acquire some education about ergonomics and initiate a plan for training, then having learned more about what to monitor in the workplace, establish a surveillance system. Conduct job analyses as prioritized by the surveillance system and proactively assess new designs. Finally, implement improvements for a safe, healthy, and productive business. Figure 13.2 illustrates the process components of which discussion follows.

1. Management Commitment and Employee Involvement

A. Management commitment

Management commitment is fundamental to the success of an ergonomics program. Several aspects of commitment are discussed.

- *Is essential.* Lack of management commitment undermines any ergonomics program, however well that program may have been conceived and initiated. Small companies have an advantage, as top management is more involved in the details of the production or service and closer alliances

with the line workers are forged. Demonstrate commitment to the ergonomics process by presenting a positive attitude. Management attitude indicates the true priorities of the company to the employees. Commitment also affects whether a program matures to become a way of doing business. If a culture change is required for the success of the program, then the vision, expertise, and example of management are essential.

- *Must be communicated.* To enhance communication consider the following points.
 - Verbally communicate the importance of ergonomics as the means to a safe, healthy, and efficient workplace.
 - Express interest to give a message that the program is important and to instill energy, pride, and quality work in employees. Reinforce the commitment by an ergonomics policy or including the statement in the overall company policy and mission statement.
 - State the program objectives clearly to ensure that employees understand the reasons for changes.
- *Is set by example.* The behavior of an owner and the managers will convey more than a written statement or formally expressed policy. Set an example by displaying an active interest in how the work is performed by the employee and whether the job demands are reasonable. Closely monitor the injuries and illnesses records and follow safety requirements when in the work areas, such as donning personal protective equipment. Convey the importance of ergonomics in productivity by showing concern for the best environment and methods when looking to improve the process and production.
- *Entails employee involvement.* Employees are a valuable source of information and ideas. Involve employees in the process to accomplish effective ergonomics. This also demonstrates the respect and expectations management has for employees.
- *Requires clear responsibilities.* Involve the employees in program development to initiate active participation. As the program develops, clearly delineate the roles, assignments, and responsibilities of those involved. A common downfall of an ergonomics process is the lack of project follow-through for implementation and confirmation of effectiveness. Establish responsibility for project follow-through.
- *Entails the provision of resources.* Provide employees with the training and the time to contribute to the program. Provide authority for decisions to be made and money allocated to implement the projects to meet the program objectives.

B. Employee involvement

Management should support and facilitate employee involvement. The employees know the jobs best. They are an excellent source of ideas for improvements and are the ones required to work with any implemented changes.

- *Set up a core task force.* Certain knowledge and perspectives are needed to contribute to an ergonomics program. How the individuals are included depends on the structure of the program and the formality of a task force or team. To establish a core task force, designate a person to monitor the program and individuals to be responsible for specific aspects of the program. Clearly define the roles and responsibilities. The identification of the primary problems, their root causes and potential solutions come from the contribution of many perspectives during problem solving. The following are the departments or areas that have personnel who provide a particular perspective and should be considered on an ergonomics team. In a small business, some of these departments are combined.
- *Operators.* Those who perform the job usually know the most about it. How the job is done is essential information and may be contrary to the way it was theoretically designed. The operators know the difficulties in performing a job and often have ideas for improvement. The operators will continue doing their jobs after improvements are made so their acceptance of any changes is important.

- *Human Resources.* In small companies, information about turnover, absenteeism, accident records, OSHA logs, and workers' compensation records is often kept in the human resources office. Turnover is typically low in small companies and less likely to be an indicator of a problem job. Absenteeism and sick days, however, should be monitored, as they may reflect an employee's attempt to counteract the high demands of a job.
- *Safety and Health/Medical.* Accident information and related records may reside in the safety and health department rather than in human resources. Apart from medical treatment, medical personnel generally handle return-to-work issues and job modifications to accommodate medical restrictions.
- *Engineering/Maintenance/Facilities.* Knowledge about the mechanical aspects of the production system and the environment helps when determining the workplace redesign potentials and the related costs. The involvement of engineering personnel is also necessary to ensure that ergonomics is incorporated.
- *Production Engineers and Quality Control.* Personnel overseeing production and quality contribute information that helps to identify problem areas. Their perspective is useful in problem solving and assessing potential solutions.
- *Management/Supervisors.* In small companies management is likely to be involved, therefore providing decision-making authority. Management support is necessary for effective implementation of administrative controls.
- *Purchasing.* Involvement of the purchasing department ensures that the best products are purchased based on their function and quality as well as cost. For example, an inexpensive drill bit may seem a good bargain at first, but uneven wear of the bit may cause the worker to use excess force and may increase the risk of injury from the drill slipping.
- *Set clear responsibilities.* An ergonomics process that is fully integrated into the company processes is likely to be the responsibility of everyone. However, one person or group usually becomes the resident "expert" or ergonomics resource. That person or group may be responsible for establishing and keeping ergonomics "alive" within the company.
- *Use existing task forces or teams if possible.* Combining committees or teams helps to prevent redundancy of efforts and reduces the time employees are away from production. However, this lessens the opportunity for employee involvement. A rotation onto a task force and *ad hoc* involvement help to include more people.

C. Written program

A written program is often emphasized as essential for a successful program. However, the typical reaction of a small business to this suggestion is "more paper work." There are many advantages to putting down in writing the basics, such as the objectives and who is involved. Writing the program basics helps to:

- Get the program started more efficiently
- Organize thoughts and the best plan of action
- Clearly communicate the process
- Make it easier to introduce the process to a newcomer
- Establish the goals and achievements by which the program can be assessed for success and improvement

The written program need not be a lengthy document but rather a clear statement conveying the objectives, goals, and processes to establish and continue ergonomics within the company. A schematic in Figure 13.2 helps provide an overall picture. Consider writing the document so that it includes other functions such as training. For example, a section that outlines the medical management procedure for a work injury could be used during orientation training of new employees. A written program need not be an independent document but may be incorporated into other processes within the company, such

as the safety and health program or quality management process. Consider including the following in the document:

- An overall schematic of the components and process
- Program objectives
- A list of those involved (or of job positions) and their responsibilities
- The program process (e.g., who gets training, to what extent, and by whom)
- A section for the project action list, analyses, and record of changes and their effectiveness (these could be the minutes from project meetings)

In addition, it is important to record the goals and action items to establish the program, so that there is accountability.

2. Medical Management

A primary responsibility of a company is to respond to work-related medical problems reported by employees. The medical conditions require treatment and correction of the cause to prevent recurrence. Medical management *per se* is not in the realm of ergonomics; however, early detection, prompt treatment and quick return to work have direct bearing on the recorded injuries and illnesses. If poor design at work caused or contributed to the medical condition, then improvement of the workplace is essential to prevent recurrence. Good communication between the medical community and the company is important to successfully improve the incidence of work-related injuries.

An industry with a large number of medical cases should start its ergonomics process by addressing medical management. Many companies have dramatically reduced their workers' compensation costs in as short a time as one year by improving the medical management of existing and emerging cases (Stuart-Buttle, 1993). Small industries do not usually have in-house medical departments, thus it can be difficult to control medical management. For a company with 600 employees or more, the employment of an in-house health care professional (HCP) may be beneficial, particularly if there are a large number of employees requiring treatment. Contracting with a medical group to provide onsite services or using an occupational medicine group in the community are possible alternatives. Industrial or occupational medicine centers are becoming more common. A small company may have difficulty in finding the services, or having access to the service, especially if the company is located in a rural area. However, it may be possible to develop a relationship with a local medical group that is prepared to acquire the expertise the company needs. Trade groups, professional groups, or the company's workers' compensation carrier may be able to provide guidance and referral to occupational medical groups.

The company has some control over the quality of the services rendered. The following suggestions may help to establish a good working relationship:

- *Establish close communication.* Assign a primary contact person in the company and have him or her establish a rapport with the medical group or HCP.
- *Communicate the expertise expected of the medical group.* The company should make clear the type of medical expertise that is required. For example, if vibration exposure is inherent in the job, then the medical practice needs to have some experience or willingness to acquire training in screening for vibration white finger.
- *Introduce the medical group to the plant's culture and processes.* When the HCP understands the jobs, he or she may be able to give specific job restrictions and helpful guidance on job modifications or alternative jobs. This promotes return to work more quickly and successfully. The HCP may also assist in progressing the worker through various modified jobs until the worker is able to return to work at the previous job or an equivalent.
- *Consider the medical community as a training resource.* The local medical or rehabilitation group may also be a source for education of employees in health-related topics, such as back care and exercise programs.

3. Education and Training

First, some general education in ergonomics is needed by someone in the company so as to plan an ergonomics program. In-depth training is recommended for a specified team, and general awareness training is recommended for managers, supervisors, and line workers. The extent of investment in training may depend upon the financial resources and the turnover rate. A smaller team may be trained to save costs, but everyone should receive some awareness training. If a company suspects there are many problems requiring improvement, it may be helpful to train gradually. The team should be trained to respond effectively to the increase in reports that may occur after general awareness training of the employees. Lack of a response of the team may invite cynicism and reduce participation of the line workers.

A. In-depth training

At the very least in-depth training is recommended for the person or team primarily responsible and involved with ergonomics. This does not mean that the recipients have to become ergonomists but rather the training objectives are to:

- Understand the overall program objectives, goals, and process
- Understand the injury and illness system for treatment, return to work, and job modifications
- Be able to correctly record and interpret medical records and OSHA logs for surveillance purposes
- Know how to conduct basic problem-solving job analysis for ergonomics issues
- Recognize risk factors for injury and illness in workplace design
- Be able to develop, implement, and affirm effectiveness of solutions to basic problems
- Understand basic ergonomics principles to apply to solutions and new designs
- Be familiar with outside resources and methods for finding resources

B. Awareness training

An awareness level of ergonomics training prepares employees to participate in the ergonomics process. A program can become less reactive and more prevention-oriented when there is greater understanding and contribution of all the employees. The objectives of an awareness level of training are for the employees to:

- Generally understand the ergonomics program
- Appreciate their role and responsibilities in the program
- Recognize the early indicators of physical problems
- Understand the company medical management system
- Understand basic risk factors for injuries and illnesses
- Know basic ergonomics principles
- Understand their participation in job analyses

To train those employees who work in jobs with identified physical risk factors may cause the company to lose the opportunity to improve areas from a production or quality standpoint. An awareness level of training is recommended for all employees. New employees should be trained to maintain the knowledge base in the workforce. There are many resources for basic training. Commercial videos and training programs are available, as are companies that conduct training programs. Those who received in-depth training may also be able to provide the awareness training. It is not unusual to give separate programs for supervisors, management, and production workers as there may be differences in educational levels and perspectives of each group.

C. Refresher training

Refresher sessions maintain interest in ergonomics. As with the ergonomics program or process itself, the refresher sessions can be part of other processes in the company, such as continuous improvement or safety and health.

Additional training may be beneficial for either the task force or the in-house “expert.” The extent of extra training can vary according to the degree of investment the company wishes to make. Some companies have found that when employees receive training and are empowered to contribute, many issues are addressed by the employees themselves (Burson, 1993).

4. Surveillance

An initial step to improving the workplace is to identify the areas with problems or the potential for improvement. This entails looking at data that have already been collected by the company. Such data include information on injuries and accidents, production and quality measures, and personnel records.

A. Methods

- *Medical information.* The first priority is the jobs at which injuries or illnesses have been reported. The OSHA 200 logs, workers’ compensation records, first aid logs, and accident records are all sources of data from which to determine problem areas. For small companies, the numbers can be small and hard to interpret. For example, only one person in a department may have a physical problem, which may or may not mean other employees will also develop a problem. Statistical analyses on small samples are less feasible, making trends difficult to determine. Although it may not be statistically feasible to detect trends, it may be useful to informally determine if there are patterns in data or performance.

Government statistics for given SIC codes can be used as a benchmark against which company performance can be compared. If the number of cases on the OSHA 200 logs is at least five for the year, and this figure is converted to an incidence rate, it can be compared to the annually published figures of the Bureau of Labor Statistics (BLS). The BLS can also be telephoned to find the rate for a given SIC code if it has not been published. Calculation of incidence rates is described in the recordkeeping guidelines for the OSHA 200 logs (BLS, 1986).

- *Discomfort surveys.* Occupational medical cases often go unrecorded, because employees tend to report to their personal physicians rather than to the company. This can occur especially in smaller companies in which there is no medical department. Furthermore, the collaborative nature of a small company often deters absence from the job and hence the reporting of a problem. Finding out who is working with discomfort attributable to the workplace and treating those conditions promptly are important for two main reasons:
 - The medical outcome is more successful and occurs more quickly, and it prevents the person from experiencing unnecessary hardship.
 - The treatment and lost time costs are lower when the condition is less severe.

The main way to encourage early reporting is through education of the employees so that they understand the benefit in the long term. In addition, supervisors and managers need to understand the benefit of early treatment as well as encourage the employees to report. Detailed symptom surveys can be used as a formal mechanism for finding those with work-related medical problems. However, such surveys may be of limited value to the small company due to statistical constraints and the need for medical knowledge for interpretation.

Improving the jobs that provoke discomfort and fatigue can reduce the likelihood of an illness or injury occurrence. These jobs provoke a performance decrement, for example, a reduction in productivity, a high number of rejects, or an increase in absenteeism or sick days. Data demonstrating reduced performance and subjective discomfort can be collected either informally through interviews and focus groups or formally through questionnaires and discomfort surveys (Stuart-Buttle, 1994). A discomfort survey typically contains a simple body diagram that is shaded by the respondent to indicate areas of discomfort. Ratings of the intensity of the discomfort are also marked for each shaded area. A valuable addition to a survey is questions about the cause of the problem and requests for suggestions for improvement (Burson, 1993; Stuart-Buttle, 1994).

To attempt to uncover physical issues before they become medical problems does not necessarily mean “opening a can of worms” necessitating responses to a flood of reports. If there is likelihood of too many reports to handle at one time, the departments or areas can be surveyed sequentially. Soliciting information consecutively by area, or specifically by task, helps to gather information pertinent to improvements. Surveying the whole plant provides a useful baseline and helps to prioritize the departments or jobs to be assessed. If the number of jobs is large, the circumstances of the job may change before the area is addressed, thereby making the survey less useful. Job rotation can make the interpretation of surveys difficult as the connection of discomfort to a particular task is less distinct. There are also inherent problems with discomfort surveys, for example, discomfort would not be reported by those who are “survivors” at the job.

- *Absenteeism and turnover.* Both of these can be indicators of difficult or stressful jobs that may warrant redesign. There may be insufficient data due to company size upon which to draw formal conclusions, but exit interviews and informal investigation may indicate the roots of a problem.
- *Production and quality data.* Data related to worker performance can be indicators of a mismatch of the workplace to the employee. Production may be lower than necessary if the worker takes longer to perform the job because of awkward postures or an inefficient layout. A change in production rate can also occur if the worker slows due to fatigue or discomfort. Rework, rejects, and mistakes are measurable aspects of performance that job redesign can improve. Errors may be due to a variety of causes including physical fatigue, cognitive or perceptual limitations, environmental distractions, or psychological and social stresses. So finding the primary cause is important to improve the job.
- *Accident investigation.* Traditionally, accident investigations tend to guide a company to accept the workplace design and look for behavioral shortcomings or system and equipment failures. The existing design falls short of being questioned during the investigations. Accidents and near misses should be investigated with ergonomics in mind because an inadequate design may be a contributing factor.
- *Audits.* Conducting an audit to determine problem areas or areas of potential improvement is proactive. The scale of a small business lends itself to auditing ergonomics at the same time as other system checks. Consider including ergonomics audits with safety and production improvement reviews. A checklist approach is common, and there are many checklists available on the market. However, consider tailoring one to capture the industry-specific issues. Checklists should be used only as a reminder of what to look for since they do not adequately address the interactions of risk factors or of the worker with the workplace.
- *Interview and employee reports.* Open-ended interviews, focus groups, and employee suggestions are other ways to identify problem areas.

B. Prioritizing

Problem areas need to be prioritized to develop an effective action plan. A scoring system, which assigns a number for the presence of an indicator of a problem, is a questionable method by which to prioritize, because very different data are gathered as indicators of a problem area. Another approach that can be useful is to develop a spreadsheet with types of indicators or data by departments, areas, or jobs. The amount and extent of the indicators can be used to qualitatively rank the problem areas in conference with other team members or employees. Consider factors such as the anticipated scope and difficulty of the project or whether the area or job is about to be changed for production reasons, because these factors also influence the priority. At the beginning of a program, undertake projects that appear to be relatively easy and inexpensive so there are some early successes.

5. Job Analyses

Job analyses can be conducted from a reactive or proactive stance. A reactive analysis is evaluating a job known to have problems. A program usually starts from a reactive standpoint in response to injuries and illnesses that have occurred. A proactive analysis is looking at a new design, recent installation, or redesign

to anticipate problems and ensure that the workstation incorporates ergonomic principles. A proactive approach should be implemented as early as possible in an ergonomics program not only to prevent new problems arising, but also to avoid remaining in a reactive position which is more expensive in the long run compared to designing well initially.

Start the program with small and simple projects and complete many of them. This is an effective way to involve employees from many areas and to build interest and full support for ergonomics. Learn by doing, getting more training, and taking on more challenging projects as experience builds. However, remember that using an expert may be necessary for complex problems and may be a time- and cost-saving measure.

A. Responsibility for conducting analyses

One of the decisions in designing the ergonomics process centers on who will conduct the actual ergonomics analyses. A team approach can be used in which the group collects the data, looks at the problem, brainstorms for the root causes, and generates potential solutions. Alternatively, one person may actually go and collect the data using interviews or videotaping, for example, and present to the team for a group brainstorming. It is not uncommon, particularly in a small company, for a process to develop in which one person collects data, analyzes it, and generates the solutions with informal input from others. Caution should be used when adopting an isolationist approach, as, over time, any joint responsibility for ergonomics might lessen because of a lack of involvement, ergonomics principles will perhaps no longer be applied by everyone, and the program might be perceived as one person's responsibility. When this occurs, ergonomics has not been sufficiently integrated into the company processes.

There are many sources of data that indicate ergonomics issues. Who collects the data depends on company resources and the complexity of the problems. In small companies an individual may be responsible, for example, for human resource issues, safety and health, as well as fulfill the function of sales manager. Owing to the multiple positions typically held, the ergonomics team would be small with less input, although with multiple perspectives.

Some companies choose not to invest in in-depth education of an employee but rather work with an external expert who gets to know the company process and culture. The decision about whether to have an internal or external "expert" depends upon the size and resources of the company and the other responsibilities of the "expert" within the company. The approach chosen also depends on the amount and complexity of the issues to be addressed. There may be benefit in having more in-house knowledge if the production process changes frequently. The company needs sufficient understanding of ergonomics to know when assistance is needed, how to find it, and where to get further information to address the issues.

B. Problem solving

The root causes of poor design are identified through careful analyses. A good problem list helps generate the best possible solutions. For example, after detailed analyses it may be determined that a material is rehandled unnecessarily and that the handling can be eliminated, whereas a more casual look at the job may have focused on improving the handling, incurring higher costs to make improvements and less productivity savings by not eliminating the step. Ineffective or expensive improvements may also be decided upon unnecessarily if a casual approach to analyses is adopted. The traditionally informal structure of small industry does not preclude good problem solving, nor does careful, detailed problem solving always require extensive quantification. A key to ergonomic problem solving is to repeatedly question if a job can be performed a better way. If the issue does not appear straightforward, assistance should be sought.

C. Quantification

Quantification assures that what is perceived as a problem is in fact a problem, and to what extent. Quantification also helps to assess improvements to determine the best alternative, and it provides a measure of effectiveness and cost benefit. However, quantification is unusual in small businesses and is discouraged, especially when the decision makers are already convinced of the benefit. Measurement

should always be selective, that is, collecting necessary data rather than what is possible to collect. Unnecessary measurements increase the cost of analysis. A simple problem with straightforward improvements may be more informally approached although thorough problem solving is always essential. When the situation is more complex, selective quantification assures appropriate design decisions are made and helps prevent the generation of new problems.

As Brough (1996) pointed out, the overall program objectives need to be kept in mind during analyses, that is, to design a safer, more productive workplace. The budget can easily be consumed by using elaborate materials and computer programs that produce more data than needed and that require more time for analysis than correcting the workplace problems.

D. Analysis

Discussion of the many analysis methods and tools is outside the scope of this chapter. However, some discussion about checklists is appropriate since they are widely used. An overview of the basic steps in an applied analysis is provided as a guide.

- *Checklist.* A checklist is a popular applied method for identifying and prioritizing the problem areas. However, caution should be taken when using a checklist as an analysis tool, because it does not address the interactions in a job. Checklists may serve as a reminder of the issues that indicate a poor design. A checklist can be useful for assessing a new design.
- *Workstation analysis.* The following steps provide a general overview of an approach in the analysis of a workstation.
 - Clearly define the job function and the tasks, so that they are understood in context with the overall system.
 - Collect pertinent job information such as performance rates and quality expectations.
 - Interview employees.
 - Describe the component actions of each task (possibly videotape them if the task is complex or fast).
 - Identify the risk factors and job components that place excessive demand on the worker or that make the job awkward or inefficient.
 - Assess the risk factors and job demands quantitatively and qualitatively.
 - Determine the root causes of the risk factors, job demands, and awkward methods.
 - Develop a primary problem list with possible causes.
 - Brainstorm for several short- and long-term solutions to the problems, especially ones that are inexpensive.
 - Assess the cost benefits of alternative solutions.
 - Develop an implementation plan including a trial stage if necessary.
 - Reassess the solution after implementation to determine its effectiveness.
 - Record the project.
- *New design.* Incorporate ergonomics into the process of purchasing new equipment, designing new layouts, or redesigning an existing area or workplace in the plant. If ergonomics is addressed at this stage, there will be minimal subsequent concerns and better productivity from the beginning of equipment startup. A checklist may help to consider all the ergonomic aspects, but the interaction of the operators with the equipment or layout should be especially anticipated and critiqued. Company engineers should have at least basic knowledge of ergonomics and work closely with other personnel to ensure that all safety and quality standards are met.

Maintenance requirements are commonly forgotten. Evaluate new designs for access and ease of maintenance. The time lost from awkward access, for example, the need to fetch and use a ladder to reach a control, can be considerable. The physical toll on the employee from difficult maintenance is also a cost to the company. Set up a preventative maintenance schedule for the equipment and facility. Equipment that is not properly maintained can increase the forces or control required of the operator, making the job harder to perform.

At times corporate memory can be very short. Design mistakes can be repeated, often when there are new people who are unaware of the history of changes at a workplace. A small industry does not experience such forgetfulness as much as a larger company because turnover or movement within the company is less. However, a project record may still be helpful to prevent repeating earlier trials and errors.

6. Controls and Improvements

Effective problem solving usually generates more than one solution, typically long-term and short-term ones of various expense. The solutions may incorporate administrative and engineering approaches. Although engineering solutions are perceived as more permanent and less dependent upon human behavior, it is not uncommon to need an administrative measure to accompany an engineering change. An advantage in a smaller company is that employees are more likely to be cross-trained so that administrative controls, such as job rotation, are easier to implement.

A. Engineering changes

Engineering solutions vary considerably by type of industry. The company has knowledge of equipment that is specific to the industry but often finds it difficult to locate any other equipment that might be a design solution. A small company has less time to search the market due to the multiple job functions held by personnel. Therefore, a company may find it worthwhile to develop outside resources that can reduce search time.

B. Administrative changes

Administrative changes can entail organizational and policy changes. Quota systems, break patterns, rotation methods, and overtime are common aspects that are addressed to improve the balance of job demands. Sometimes changes in purchasing policies may be indicated. The common practice of buying the cheapest is not always cost effective, particularly if the item is of poor quality and adds stress and time to do the job.

C. Follow-through

A small company has the advantage of closer communication and more management involvement so there is focus when the decision is made to address a project. Therefore, follow-through to ensure implementation and effectiveness is easier than in a large corporation, where often many jobs are analyzed but few changes are made. Even so, roles must be defined clearly for accountability, particularly if there is a team approach. After ergonomics awareness training, many small improvements can be made from the plant floor by employees and supervisors.

D. Cost benefits

In a small industry the cost benefit of an improvement cannot be based on injury and illness alone because there are fewer incidents and they may be scattered throughout the facility. Therefore, gains in productivity and quality become important in the cost benefit equation. Of course productivity and quality are important components for all businesses, but companies with more employees often have more incidents (but not necessarily higher incidence rates) and potentially more people that may be affected, so that injury and illness costs may be the basis for justification.

13.6 Summary

When a small industry sets up an ergonomics process there are many factors that influence the development of the process. The main factors relate to the unique characteristics associated with small company size. Characteristics commonly found are less formality, responsibility for several positions, greater responsiveness, a less specific knowledge, more management involvement, and a less data-oriented approach. By being aware of these influences a small business may successfully incorporate ergonomics, especially if it focuses on the productivity and quality benefits.

References

- American National Standards Institute (ANSI). 1988. *American National Standard for Human Factors Engineering of Visual Display Terminal Workstations*. ANSI/HFS 100-1988. The Human Factors Society, Inc., Santa Monica, CA.
- American National Standards Institute (ANSI). 1996. *Control of Work-Related Cumulative Trauma Disorders. Part 1: Upper Extremities*. Draft, August 29. ANSI Z365. National Safety Council, Itasca, IL.
- Armstrong, J. 1995. Personal communication. U.S. Small Business Administration.
- Brough, W. R. 1996. Make your ergonomics program a powerful tool. *Safety and Health*. February:109.
- Bureau of Labor Statistics (BLS). 1986. *Recordkeeping Guidelines for Occupational Injuries and Illnesses*. OMB. No. 1220-0029, U.S. Government Printing Office, Washington, D.C.
- Bureau of Labor Statistics (BLS). 1992. Occupational Injuries and Illnesses in the United States by Industry, 1990. Bureau of Labor Statistics, April, Bulletin 2399:37.
- Bureau of Labor Statistics (BLS). 1995. Excerpts from annual BLS survey; occupational injuries and illnesses in 1994. *Occupational Safety and Health Reporter*. 12-20-95:1002.
- Bureau of National Affairs (BNA). 1993. Effective programs reduce liability from OSHA- and ADA-related charges, group told. *Occupational Safety and Health Reporter*. 10-13-93:527.
- Bureau of National Affairs (BNA). 1996. Safety programs cited as factor in 18 percent drop in employer costs. *Occupational Safety and Health Reporter*. 1-3-96:1053.
- Burson, R. 1993. Find it and fix it. *Ohio Monitor*. November/December:8-11.
- EEOC, 1990. *Americans with Disabilities Act of 1990*. Public Law 101-336 101st Congress, July, 26. U.S. Government Printing Office, Washington, D.C.
- EEOC, 1964. *Title VII, Civil Rights Act of 1964*. U.S. Government Printing Office, Washington, D.C.
- Elson, I.J. 1994. Implementing an ergonomics program under real world constraints, in *Advances in Industrial Ergonomics and Safety VI*, Ed. F. Aghazadeh, p. 177-180. Taylor and Francis, Philadelphia, PA.
- Esposito, P. 1996. Program management guidelines: A safety and health management system. *The Synergist*. August:27-29.
- Järvinen, J., Karwowski, W., and Lepistö, J. 1991. The overexertion injury due to manual lifting: another irony of automated manufacturing, in *Advances in Industrial Ergonomics and Safety III*, Eds. W. Karwowski and J.W. Yates, p. 201-207. Taylor and Francis, Philadelphia, PA.
- Occupational Safety and Health Administration (OSHA). 1970. *Occupational Safety and Health Act*. Public Law 91-596 91st Congress S. 2193 Dec. 29. U.S. Government Printing Office, Washington, D.C.
- Occupational Safety and Health Administration (OSHA). 1989. Safety and health program management guidelines. *Federal Register*, 54(16):3904-3916.
- Occupational Safety and Health Administration (OSHA). 1990. *Ergonomics Program Management Guidelines for Meatpacking Plants*. OSHA 3123. Department of Labor/OSHA, Washington, D.C.
- Occupational Safety and Health Administration (OSHA). 1992. *OSHA Handbook for Small Businesses*. OSHA 2209. Department of Labor/OSHA, Washington, D.C.
- Office of Management and Budget (OMB). 1987. *Standard Industrial Classification Manual*, PB 87-100012. National Technical Information Service, Springfield, VA.
- Olsheski, J.A. and Breslin, R.E. 1996. The Americans with Disabilities Act: Implications for the use of ergonomics in rehabilitation, in *Occupational Ergonomics: Theory and Applications*, Eds. A. Bhat-tacharya and J.D. McGlothlin, p. 669-683. Marcel Dekker, Inc., New York, NY.
- Oxenburgh, M. 1991. *Increasing Productivity and Profit Through Health and Safety*, CCH International, Australia.
- Robinson, A. (Ed.) 1991. *Continuous Improvement in Operations: A Systematic Approach to Waste Reduction*, Productivity Press, Cambridge, MA.
- Rose, S. 1993. Personal communication. Regional Size Program Manager, U.S. Small Business Administration.

- Small Business Administration (SBA). 1993. *The State of Small Business: A Report of the President*, U.S. Government Printing Office, Washington, D.C.
- Stuart-Buttle, C. 1993. *Small Industry Programs*. Paper presented at “Low Back Injury Symposium” at Ohio State University, Columbus, Ohio.
- Stuart-Buttle, C. 1994. A discomfort survey in a poultry-processing plant. *Applied Ergonomics*. 25(1):47-52.
- The Synergist, 1994. Reach out to small business owners to improve health and safety, IH professionals told. *The Synergist*. June/July:12.
- The Synergist, 1995. Graphically speaking. *The Synergist*. October:7.
- Wortham, S. 1994. Britain’s small businesses face big safety issues. *Safety and Health*. February:66-67.

14

The Role of Ergonomics Training in Industry

14.1	Introduction	14-1
14.2	Training and the Macroergonomics Approach.....	14-2
14.3	Justifying the Need for Ergonomics Training.....	14-3
	Is the Organization in a Highly Competitive Market for Its Products or Services? • Can Human Error Cause Severe Consequences? • Do the Manufacturing Engineers and Workforce Struggle to Manufacture What the Designers Design? • Are Changing Technologies and Customer Demand Posing Major Challenges? • Are the Demographics of the Current Workforce Changing? • Is There a High Demand for Productivity and Quality? • Do High Workers' Compensation and Medical Costs as well as High Absenteeism Disrupt the Business on a Daily Basis?	
14.4	Identifying the Audience and Type of Training.....	14-4
	Briefing for Senior Management Training for Health and Safety Professionals, Engineers, Ergonomics Steering Team, and Facilities Managers, Buyers • Advanced Training for Manufacturing, Process, and Industrial Engineers • Training for Supervisors, Ergonomics Team Members, and Labor Representatives • Training for Hourly Workers • Training for Design Engineers • Training for Risk Managers, Department Managers, Human Resource Managers, Occupational Physicians	
14.5	Measuring the Impact of Ergonomics Training	14-7
	Impact on the Person • Impact on the Job • Impact on the Organization	
14.6	Characteristics of Good Training	14-9
14.7	Conclusion.....	14-10

Marilyn Joyce
*The Joyce Institute
Arthur D. Little, Inc.
Cambridge, MA*

14.1 Introduction

In recent years, ergonomics training has become recognized as a critical element in implementing an ergonomics program within an organization. The type of training, the relative importance placed on it, the expectations for outcomes, and the audience vary widely among organizations.

Ergonomics training, when it is part of a comprehensive, systematic approach to integrating ergonomics into an organization, can play a key role in enabling an organization, regardless of its size, to gain “ergonomic self-reliance.” Often, when people first think of ergonomics training, they think only of “worker” training, when, in reality, training workers without first training others responsible for ergonomics can be counterproductive. As we will detail later in the chapter, training needs to be tailored to each of the

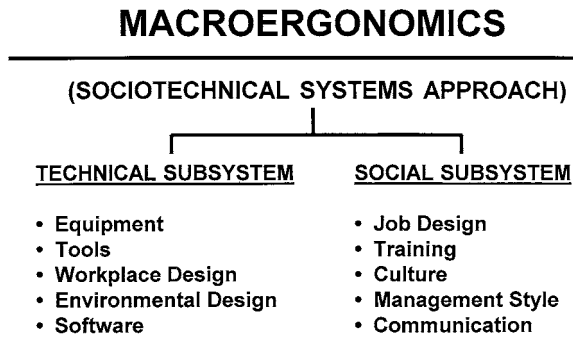

FIGURE 14.1

following audiences within the organization: senior management; design engineers; manufacturing, process, industrial, and facilities engineers; health and safety professionals; human resources and risk management; operations managers and supervisors; and buyers.

Ergonomics training involves developing the attitudes and competencies at all levels within the organization so that people have the knowledge, skills, and motivation to fulfill their role in ergonomics implementation. Of course, training is a means to an end, not the end itself. In other words, “providing training” does not constitute implementing ergonomics; the only reason to train is to enable the participants to make changes consistent with their role in the organization. The purpose of this chapter on training is to provide the rationale for training and the practical guidelines for designing ergonomics training in such a way that participants make changes that can be measured in terms of their impact on the workers, the jobs, and the organization.

14.2 Training and the Macroergonomics Approach

For an ergonomics program to sustain itself over a long period, it must be perceived as a value-added element in the organization and must be integrated in the nature of the organization. Training is the catalyst for that process. The purpose of training is to bring about change in the workplace that can be measured in terms of safety, productivity, and quality. In order to achieve this goal, ergonomics training needs to be part of a comprehensive ergonomics plan, based on a macroergonomics approach.

Macroergonomics is an organizational design approach that includes both the technical subsystems (design of environments, equipment, workstation, etc.) and social subsystems (job design, training, management style, relationships between management and workers, communication, etc.) In other words, a macroergonomics approach deals with the impact of work on both the physical and the cognitive aspects of employees. (See Figure 14.1. It includes what is referred to as both ergonomics and human factors.)

Training provides the means by which people’s performance and well-being are enhanced to maximize an organization’s investment in people and technology. If a manufacturer has its design engineers designing consumer products, but does not train them in ergonomics, then the company is inhibiting the designer from producing the best product available because the consumer’s needs may not be met; if an employer purchases ergonomically sound power tools and provides reasonable workstations, but does not train the managers and supervisors in the basics of job design, then injuries could still occur because the needs of workers may not be met.

The key questions to be asked then, are these:

- How does ergonomics relate to and contribute to our core business functions?
- Whom, when, and what do we train?
- How do we set up the metrics to document the results of training?

14.3 Justifying the Need for Ergonomics Training

Even though by definition “ergonomics addresses human performance and well-being in relation to the job, the equipment, the tools and environment,” many organizations only associate ergonomics with safety and injury prevention. The focus is sometimes so strong, that it obscures the impact that ergonomics training can have on the primary business of the organization. Ergonomics training can contribute to the core business functions by addressing the work process, the workplace, and the work product.

An organization can determine if it needs ergonomics training on the basis of contributing to its core business functions by asking the questions listed next.

Is the Organization in a Highly Competitive Market for Its Products or Services?

If so, ergonomics training that improves the product design, decreases turnaround times, saves materials costs, or minimizes employee turnover can help the organization be more competitive.

Can Human Error Cause Severe Consequences?

If there are a lot of near misses occurring or if human error can result in severe injuries to employees, damage to products, or damage to the plant, then ergonomics training may need to focus on those involved in changing the design of the workplace or process or on those actually doing the job. For example, in chemical plants or petrochemical sites where alertness and attentiveness to visual displays in a control room can mean the difference in reaction time and appropriate decisions, the design of the control room itself, the nature and position of the controls and displays, and the work organization issues, all need to be addressed through training in ergonomics/human factors.

Do the Manufacturing Engineers and Workforce Struggle to Manufacture What the Designers Design?

Ergonomics training can be helpful in facilitating the manufacturing process if there is enhanced cooperation between the designers and those responsible for producing the product. Examples of issues include: determining whether assembly processes should be done in a series of subassemblies to minimize awkward postures for extended periods of time; examining whether the number of fasteners used is really needed or whether the number or type can be reduced to minimize the use of power tools.

Are Changing Technologies and Customer Demand Posing Major Challenges?

The rapidly changing technologies in all types of work environments need to be considered in terms of the human interaction with those technologies if the capital investment is to have the desired results. In offices, for example, the increasing sophistication of computer systems and uses can overwhelm many workers. Ergonomics training can address the interface by addressing job design issues and workplace design issues.

For example, a Fortune 100 company reported that they minimized lost time and workers' compensation costs by implementing ergonomics in two of its units that have high production computer areas. They did so by training managers and supervisors in ergonomics so that they were aware of the importance of work organization issues, rest pauses, and attitudes toward workers; they also trained maintenance personnel so that they knew how to respond to employees' needs for adjustments; and they trained in-house trainers to conduct ergonomics awareness training for the employees.

Are the Demographics of the Current Workforce Changing?

One of the triggers for initiating ergonomics training is a change in the demographics of a workforce. For example, a reorganization often results in having a high percentage of aging workers performing a

wide range of tasks because younger workers have been laid off. Engineers and human resource professionals need ergonomics training so that they can design jobs and workplaces to accommodate the limitations of those workers, while capitalizing on capabilities that their experience brings. Also, the workers need training in ergonomics and in the job functions.

Other changes in the makeup of a workforce can also be triggers. If women or men of smaller stature are now expected to do jobs that had been designed for larger, stronger workers, injuries can skyrocket. It is important to provide ergonomics training to the engineers and managers so they can make changes to the workplace, the tools, the work organization, and the processes to enable these workers to be productive and yet safe; and it is important to train the workers in ergonomics.

Is There a High Demand for Productivity and Quality?

If the demands are increasing, and yet down time for product changeover, routine maintenance, etc. are hurting productivity, ergonomics training may be one way of addressing the issues.

Do High Workers' Compensation and Medical Costs as well as High Absenteeism Disrupt the Business on a Daily Basis?

Also, is animosity developing among the injured employees and their co-workers and management? Do co-workers resent those who are on "light duty" jobs? If so, ergonomics training may be one of the solutions to the problem. Training needs to be provided to the health and safety professionals, and case managers to address the issues of the currently injured workers and, at the same time, training needs to be provided to engineers, managers, and workers to make changes that will prevent future injuries.

If ergonomics training is justified in terms of the overall contribution that it can make to the business, it will often gain the support that it needs to succeed.

14.4 Identifying the Audience and Type of Training

As we have discussed, training applies to various audiences within the organization. Regardless of the size of the organization, it is important to design ergonomics training so that the organization, after a period of time, can handle most of its ergonomics problems internally, without relying on an ergonomics consultant for all types of implementation. One approach that is effective is to look at training in three phases: first, use a qualified consultant to provide all the initial senior management, management, ergonomics task force/teams/committees, engineering training, and to customize training for supervisors and workers; the second phase consists of training internal trainers to conduct training for workers; the third phase consists of developing a relationship with the consultant so that when problems arise that are beyond the level of knowledge of those being trained (for example, designing a new plant, or making major capital purchases of equipment or furniture), the consultant can work with the organization to assist in the problem-solving effort. The consultant can also be brought in from time to time to train additional engineers, health and safety professionals, and others requiring technical training. The goal of the training remains "ergonomics self-reliance" so that ergonomics becomes an integral part of how the organization functions (see Figure 14.2).

The training needs to be designed so that the information provided is consistent with the roles and responsibilities of each individual. The actions that will occur, or be expected as a result of the training, should also be consistent within the scope of each individual's job or position. As part of the planning process, timelines need to be established to indicate at what point in the entire process each group needs to be trained. In fact, the timing of the various levels of training is critical to the success of the program. For example, if the ergonomics steering team thinks that senior management may be unsupportive of a major ergonomics effort, often it works well to begin with a pilot project that is within the budget constraints of a sponsoring group, such as the Director of Health and Safety, in conjunction with an

AUDIENCE/TYPE OF TRAINING

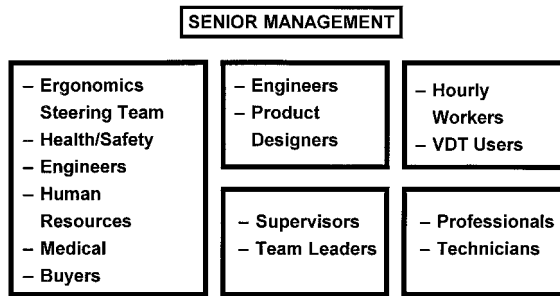

FIGURE 14.2

operations unit. If some successes can be demonstrated on a small scale, then it may be easier to make a business case for ergonomics training and implementation on a grander scale.

Briefing for Senior Management

The briefing for senior management needs to occur early in the process, after a pilot in some cases, to secure commitment of resources in personnel and capital expenditures necessary for the success of the program. The session generally needs to be one to two hours long and can be given by an ergonomics consultant or by a senior person within the organization. Since it needs to focus on the strategic importance of ergonomics within the organization, the presentation needs to include the following topics: the trends in ergonomics nationally/internationally and within the industry; the regulatory climate; the need for ergonomics in terms of the impact on this organization (hard data on workers' compensation or medical costs, down time, near misses, turnover, excessive scrap or rework, success of any pilot projects in ergonomics in the plant or company); proposed action plan; estimated costs; anticipated return on investment. If an overall ergonomics plan has not yet been developed, it is important to do so before making the presentation to management so that the training effort can be seen in context.

Training for Health and Safety Professionals, Engineers, Ergonomics Steering Team, and Facilities Managers, Buyers

The training for this group generally needs to be the first step because it provides the expertise necessary to initiate an ergonomics program and develop changes. Usually this type of training needs to be two to three days long conducted by a qualified ergonomist who is knowledgeable not only about technical issues, but also about organizational issues. If there is a corporate ergonomics policy, then the course needs to begin with a review of the policy. If there is no policy, then the course needs to include information on structuring an ergonomics plan. The course content needs to include the following: background on the underlying sciences of ergonomics, namely, anthropometry, biomechanics, physiology, and others; an overview of macroergonomics so that participants know the importance of addressing both physical and psychosocial issues; types, symptoms, and causes of musculoskeletal and stress disorders; information on how to review workers' compensation and medical logs; ergonomics principles and criteria; basic worksite analysis procedures that enable participants to identify and quantify the risk factors of the jobs so that corrective actions can be prioritized; prevention and control strategies including application of engineering, work practice, and administrative controls; documentation procedures for tracking and reporting on measurable results. The training should be as specific as possible to the plant, with videos and slides of the facility used to illustrate ergonomics principles, and serve as the basis of discussion for solutions. Most important, some type of prioritized action plan should emerge from the training.

Advanced Training for Manufacturing, Process, and Industrial Engineers

If an organization is to be self-reliant, then it needs to develop a high level of expertise. Advanced training usually requires about four to five days and needs to be conducted by a qualified ergonomist who has an engineering background. The course needs to be a combination of classroom training and practical application in the facility. The participants should have already completed a course in ergonomics before proceeding to this advanced level because the focus of the course is on advanced problem solving rather than just the basic knowledge of ergonomics. With the assumption of the prerequisite, the course content should include the following: a review of ergonomics principles and criteria; advanced worksite analysis methods, including postural, biomechanical, energy expenditure, and others; engineering and process solutions for problem jobs, including workplace layout, tool and equipment design and selection; techniques for estimating the cost and benefits of implementing the solutions; and use of software to analyze and solve problems. One of the focuses of the training can also be on designing for new facilities, new-product production processes, and new equipment so that problems are prevented.

Training for Supervisors, Ergonomics Team Members, and Labor Representatives

Supervisors, ergonomics team members and labor representatives need to participate in one-day training sessions conducted by an ergonomics consultant. The training should enable participants to: identify the causes of musculoskeletal injuries/illnesses; assist the health and safety professionals in identifying “problem” jobs, perhaps by using a checklist; make simple modifications and adjustments to the workplace; apply the principles of ergonomics as they are setting up jobs or developing work procedures; communicate with workers to support design changes and to report symptoms of discomfort early; provide input to the engineers. Supervisors can play an important role in the ergonomics process, if they are trained appropriately. They need to learn to work constructively with workers. In office environments, for example, supervisors can be trained to assist computer users to adjust their chairs and to place their hands in correct postures. They can encourage workers to take short rest pauses to give the body a chance to recover; they can keep the workload balanced so that workers can work together to get tasks completed; and they can encourage employees to use their tools and equipment properly and to follow procedures, such as buddy lifts, that are intended to keep workers from injury.

Training for Hourly Workers

Employee involvement is a critical part of any successful ergonomics implementation. The more involved workers are in the identification and correction of hazards, the more likely that the solutions will be appropriate and will be accepted by the workers. Therefore, effective worker training is essential. Initial training for hourly employees generally needs to be about two hours and should occur after training for others in the organization who will be responsible for making changes has been completed. (It can be counterproductive to begin an ergonomics training process by training hourly workers, especially in industrial environments because if participants request any changes based on what they learn in the course, their requests will need to be supported by knowledgeable supervisors, safety personnel, or engineers.) There is also a tendency in some organizations to train workers *instead of* implementing engineering or work practice controls. In other words, the entire responsibility for working safely is placed on the worker. Although the underlying assumption for worker training is that employees need to take responsibility for their own well-being, it needs to be recognized that they may need resources to assist in that process. For example, if a job requires that an employee lift 50-lb. rolls of cable from the floor to a shipping container, no matter how well the employee follows safe lifting guidelines, he may still develop problems. The problem can only be solved by someone who questions why the cable is on the floor, whether there is an alternate way of getting the cable into the container, etc. In other words, the worker will need support in changing the job so that it has minimal risks.

Ergonomics training should include: reminders that the employees are responsible for their own safety and well-being on the job; information about the body's capabilities and limitations; appropriate positions and movements; appropriate use of tools, equipment, etc.; stretches and massages which can be used to prevent the onset of muscular fatigue and discomfort; information on ergonomics principles so that they can provide valuable input to the health and safety committees and engineers during the solution design process; information on the importance of early reporting of symptoms of discomfort so the problem can be solved before serious problems develop; and tips for their overall health and well-being on and off the job, such as regular exercise, good eating habits, proper rest, attention to hobbies or second jobs that may be contributing to discomfort, etc.

Workers who are trained can really be helpful to the worksite analysis process since the process involves the use of worker surveys and/or concern logs to identify potential hazards. Workers should be consulted during the detailed task analysis for additional means of identifying potential solutions.

Training for Design Engineers

For companies that design and manufacturer products for use by other industrial companies or by consumers, ergonomics training for design engineers can offer a significant competitive edge. The training needs to be about two to three days long, taught by an ergonomics consultant experienced in product design. It needs to address the entire product life cycle, beginning with the manufacturing and assembly processes, since design decisions greatly impact the workers who are making the product. Other considerations such as distribution, installation, and disassembly can be important, depending on the nature of the product.

Training for Risk Managers, Department Managers, Human Resource Managers, Occupational Physicians

Depending on the size of the company and the division of responsibilities, department managers, technical managers, human resource managers, and buyers can attend one of the two-day sessions with the ergonomics steering team and the others. Generally a one- or two-day course can provide the background that they need to support the ergonomics efforts and to incorporate the principles into their roles. Those involved in setting policies regarding organizational structures, return to work, interface with medical management, job design and work organization, staffing, and training need to have a knowledge of: human capabilities and limitations; ergonomics principles; types and causes of musculoskeletal and stress disorders; preventive strategies; means of documenting and tracking measurable results of ergonomics implementation.

Comprehensive training to a wide range of employees, combined with a systematic approach to implementing changes, can be effective in generating a significant impact on the organization.

14.5 Measuring the Impact of Ergonomics Training

The benefits of training can be measured in several ways. These can be summarized as the Impact on the Person, Impact on the Job, and Impact on the Organization. The most significant is the Impact on the Organization since it is the culmination of the all the changes (see Figure 14.3).

Impact on the Person

In the world of training, there are several approaches to measuring the effectiveness of the training on the person who participated in the training. In ergonomics training, those that apply are measures that are observable in demonstrations in the classroom or on the plant floor during the training; results of questionnaires completed by participants; and changes that occur on the job after the training is completed. For example, engineers who are being trained can complete a job analysis of a videotaped job

MEASURING THE IMPACT OF ERGONOMICS



FIGURE 14.3

RISK RATING REDUCTION

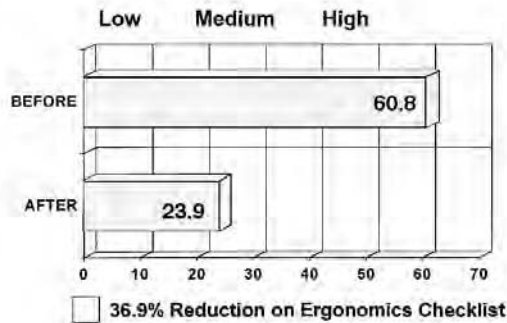

FIGURE 14.4

during a workshop segment of the training and make practical recommendations for solving the problem; supervisors can complete a checklist while they are observing a task that an office worker is doing; a safety person can assist a worker in adjusting a workstation; a worker can work with his hands in a neutral position while using a screwdriver; a worker can adjust the height of the chair to improve his or her posture; a product design engineer can eliminate the need for 30% of the fasteners required for an assembly task. In many cases, the impact on the worker can be measured by the decrease in risk factors, using a checklist, and in other cases the impact of the change is directly observable (see Figure 14.4). For example, in a large reel-handling job in a cable manufacturing plant, a small ramp was installed at each stand for a cost of \$30 each. The number of lost time injuries was reduced to zero during the first year after the installation.

Impact on the Job

The impact of training on the job can be measured by establishing a baseline and tracking individual project results. These results can be particularly effective when they are measured in terms of core business functions. For example, after training a group of engineers, managers, supervisors, and workers in one plant, a problem that was identified was that the locks that were used to keep the machine guards closed were substandard. This caused increased physical effort on the part of the workers to open and close the locks and also caused scrap. After spending \$700 to change the locks, the department saved \$6,090 in scrap and increased productivity by 20 million sheets per year, which was worth \$263,640.

A games manufacturer had been experiencing an unacceptably high number of games being returned because of damaged packaging. They also found that on the packaging line they had a high number of

MEASURABLE RESULTS

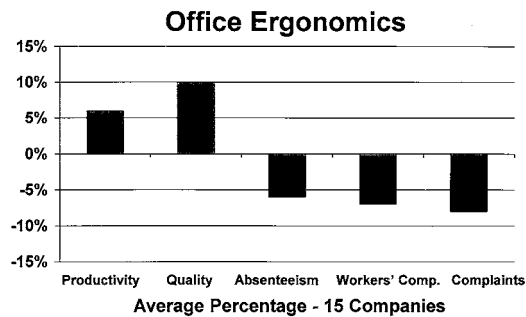

FIGURE 14.5

lost time injuries involving the shoulders and wrists. After receiving ergonomics training, the engineers decided to reconfigure the packing lines, slightly modify the cartons, and train the workers in package insertion. As a result, they improved their quality by 90%, as measured by the decrease in the returns of damaged packages, and virtually eliminated injuries to workers on that job. In office environments, many types of results are documented, including increases in productivity (see Figure 14.5).

The key to these and many other similar types of measurable results is providing training that not only provides the technical expertise to make the change, but to train the people to track the changes by involving the engineers responsible for production and quality performance and looking beyond only the safety issue.

Impact on the Organization

The most meaningful results are those that are measured by their *impact on the organization* because these are the culmination of the others and are the most likely to sustain long-term interest in and support for an ergonomics program. These can be measured by relying on company data, such as reduction in workers' compensation costs or lost days, increase in the capacity of the facility or reduced delivery time to client.

For example, an automotive parts manufacturer actively trained the key players in ergonomics, including advanced training for engineers and worker training. Over a three-year period, about 150 changes have been made to jobs. Consequently, there has been a 50% reduction in repetitive strain injuries with a 75% reduction in workers' compensation costs. The plant received an award from its corporate headquarters for Most Improved Safety Record. Another plant, a manufacturer of office products reported a savings of \$1.7 million in two and a half years as the result of implementing the ergonomics strategies that the engineers, managers, supervisors, and workers learned through ergonomics training (see Figure 14.6).

In each of these cases, the lessons learned in the training were implemented and the changes tracked and documented according to the process taught in the courses. For training to be effective, the expectation of accountability must be set from the beginning.

14.6 Characteristics of Good Training

Good training is based on adult learning theory. That means that adults learn best when the knowledge is related to their needs and draws upon their experience and expertise. The design needs to be highly interactive, including not only lectures, but also hands-on activities, and slides and videos of the particular work environment. The training materials need to be totally integrated as a manual or package, not just a collection of random articles or papers. Finally, the structure needs to develop around specific objectives so that participants leave with an action plan in place.

RESULTS OF AN ERGONOMICS PROGRAM

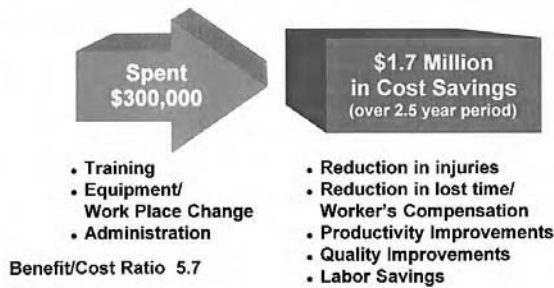

FIGURE 14.6

14.7 Conclusion

With training as the cornerstone of a comprehensive ergonomics program, organizations can experience significant decreases in injuries, improvements in productivity and quality, and a positive impact on the core business functions.

References

- Bradley, Gunilla. 1989. *Computers and the Psychosocial Work Environment*, Taylor & Francis, Bristol.
- Colombini, D., Occhipinta, E., and Menoni, O. 1993. Health education and training for workers involved in manual handling tasks, in *The Ergonomics of Manual Work*, Eds. W.S. Marras, W. Karwowski, J.L. Smith and L. Pacholski, pp. 503-506. Taylor & Francis Ltd., Bristol, PA.
- Cook, R.E. and Marcotte, A. 1990. Ergonomic improvement in games manufacturing: a case study, in *Proceedings of the Human Factors Society 34th Annual Meeting*, pp. 707-709. Santa Monica, CA: Human Factors Society.
- Hendrick, Hal W. 1986. Macroergonomics: a conceptual model for integrating human factors with organizational design, in *Human Factors in Organizational Design and Management — II*, Eds. O. Brown, Jr. and H.W. Hendrick North-Holland, Amsterdam, pp. 467-477.
- Imada, A.S. 1991. The rationale and tools of participatory ergonomics, in *Participatory Ergonomics*, Eds. Kageyu Noro and Andrew Imada, Taylor & Francis, London, pp. 30-49.
- Joyce, M. and Wallerstriner, U. 1989. *Ergonomics: Humanizing the Automated Office*. South-Western Publishing Co., Cincinnati, OH.
- Joyce, M. 1994. Ergonomics training: the cornerstone of a successful ergonomics program." In *BNAC Communicator*.
- Joyce, M. and Marcotte, A. 1996. The Business Benefits of Ergonomics, in *PRISM*; 63-71, First Quarter issue.
- Joyce, M. and Marcotte, A. 1994. *Writing and Implementing an Ergonomics Plan*, The Joyce Institute/A Unit of Arthur D. Little, Seattle, WA.
- Knowles, Malcolm. 1980. *The Adult Learner: A Neglected Species*, Houston: Gulf Publishing Co.
- Robinson, D. and Robinson, J. 1989. *Training for Impact*. Jossey-Bass Inc., San Francisco, CA.
- Wilson, John R. 1990. A framework and a context for ergonomics methodology, in *Evaluation of Human Work: A Practical Ergonomics Methodology*, Eds. John R. Wilson and E. Nigel Corlett, Taylor & Francis, London, pp. 1-29.

15

Training Issues in Industrial Ergonomics

15.1	Introduction	15-1
15.2	Systematic Design of Training Programs	15-2
	Desired Learning Outcomes • Pretraining Stage • Training Development Stage • Post-Training Stage	
15.3	Overview of Literature on Training in Ergonomics...	15-13
	Task Domain • Evaluation of Training Effectiveness in Ergonomics	
15.4	Summary	15-15

Richard J. Koubek
Wright State University

Sheau-Farn Liang
Purdue University

15.1 Introduction

Engineering controls and administrative controls are two broad categories for the industrial ergonomics. While engineering controls such as job design and workplace layout are frequently suggested, training, the major approach of administrative controls, should accompany engineering controls so that the optimal result can be achieved. It is true that a training program should always be conducted after the design has been examined since training cannot overcome a bad design. Yet, a good design also needs an effective training program to accomplish its objectives. For example, the DVORAK keyboard is a better design than the popular QWERTY keyboard since it reduces finger movements by the different arrangement of keys. However, it has not been widely accepted because most users are too resistant to changing their typing habits. That is, from another perspective, no effective training program made this change happen. In summary, training issues must be considered together with engineering controls for the improvement of the quality of work.

The goal of training programs in ergonomics is to promote productivity and occupational health through the prevention of work-related disorders. Generally, work-related disorders include the work-related musculoskeletal disorders (WMSDs), low back pain (LBP), and other health disorders due to exposures to the hazardous conditions of the workplace. WMSDs, such as tendinitis and carpal tunnel syndrome (CTS), are defined as the disorders and diseases involving the musculoskeletal system of the neck, shoulder, and upper limb, whereas LBP deals with the lumbar spine (Kuorinka and Forcier, 1995). Compared to other occupational injuries and illnesses, work-related disorders rank first in frequency of occurrence in the United States (Chenoweth, 1995). As a result, they have a great influence on the quality of life as well as on the operation of health care resources (AAOS, 1992).

The causality between occupational risk factors and work-related disorders is complicated due to the multifaceted nature of risk factors. Risk factors may have direct effects to work-related disorders but they may also have indirect effects. Further, risk factors are not independent of one another. The symptom of disorders may come from the interactions of risk factors (Kuorinka and Forcier, 1995). Although the exposure–symptom association is not fully clarified, an empirical category of risk factors associated with

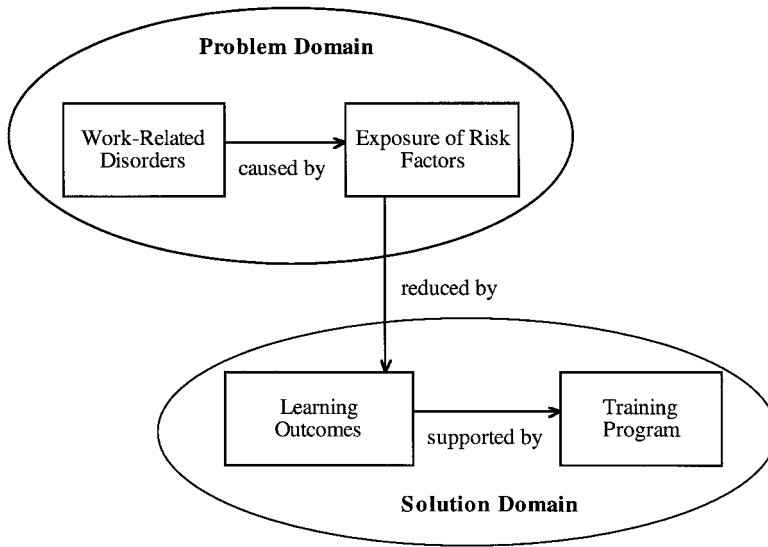

FIGURE 15.1 The conceptual model for the function of training programs in ergonomics.

the occurrence of work-related disorders is useful for the design of training programs in ergonomics. Basically, this category can be classified by two dimensions: types of risk factors (physical vs. psychological) and location of risk factors (person vs. task). Note that this category is not complete.

- Physical–person: physical fitness, capability, and limitation.
- Physical–task: working postures; task load, movement, repetition, and duration; environmental factors, such as temperature, vibration, and light.
- Psychological–person: cognitive ability; attitudes.
- Psychological–task: cognitive demands; organizational climate; psychosocial characteristics.

To design an effective ergonomic training program, the first step is to know the work-related disorders and possible risk factors. From this, the desired learning outcomes can be identified to reduce the exposure of risk factors. Finally, a training program can be developed based on these desired learning outcomes. Figure 15.1 presents this conceptual model for the function of training programs in ergonomics. There are two domains in this model: the problem domain and the solution domain. In the solution domain, the purpose of a training program is to support the learning process and facilitate the learner to achieve the desired learning outcomes. Between these two domains, it is assumed that the exposure of risk factors will be reduced if trainees acquire these learning outcomes. As a result, the corresponding work-related disorders can be reduced or avoided in the problem domain.

In this chapter, a systems approach for the design of training programs is addressed. Based on this scientific background, literature on training programs in ergonomics is reviewed and interpreted. The details of work-related disorders and risk factors are not the focus in this document.

15.2 Systematic Design of Training Programs

In order to achieve an effective training program, the first objective is to determine the knowledge, attitudes, and skills desired in the trainee. With this as the target, the second objective is to understand the current state of the trainee on these features. Upon completion of these two activities, the current status and desired goals are explicitly detailed, and a training system can then be developed to efficiently and effectively bring the trainee from the current to desired state. The following discussion first provides

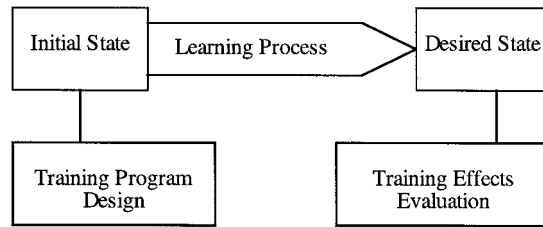

FIGURE 15.2 Training framework of instructional psychology.

an overview of the systems approach to training, followed by a more detailed description of relevant literature in each step of the training system process.

Current progress in training research has provided more perspectives. Tannenbaum and Yukl (1992) presented pretraining environment and post-training environment as important factors in training effectiveness. Organizational and social factors were also considered to impact training effectiveness (Latham and Crandall, 1991). Research on transfer of training emphasized the transfer of trainees' knowledge, skills, abilities, and other characteristics (KSAOs) from the training stage to the job (Baldwin and Ford, 1988; Ford and Sego, 1990; Ford and Wroten, 1984; Holding, 1991). Research on individual differences suggested that trainees' characteristics are important criteria for evaluating training effectiveness (Ackerman and Kyllonen, 1991). Further, research on instructional systems development (ISD) provides several training program design models based on learning theories and task analysis (Gagné, 1985; Gagné and Briggs, 1974; Gagné and Glaser, 1987; Reigeluth, 1992; Reigeluth and Curtis, 1987; Ryder and Redding, 1993; Wilson and Cole, 1992). In summary, a vast literature can be found in training research, and many training system models have been built with different emphases.

While many systematic approaches for the design of training programs have been proposed, three essential components of instructional theory from instructional psychology research appear and can be considered a simplistic framework of the training system. According to Glaser's (1976) view, these three essential components were defined as follows:

1. Initial state: the trainees' knowledge, skills, abilities, and other characteristics (KSAOs) prior to training.
2. Desired state: the competent performance that we want trainees to acquire after training.
3. The process of learning: the transition from initial state to desired state that can be achieved by training.

Snow and Swanson (1992), based on Glaser's views, added two additional components to make this framework more comprehensive. These two components are training program design and training effects evaluation. This framework is presented in Figure 15.2.

Mager (1988) classified the instructional process into four phases: analysis, development, implementation, and improvement. In the analysis phase, training objectives are identified by the analyses of training performance, task, and goal. The training prerequisites and target population are also defined in this phase. In the development phase, training evaluation criteria, relevant practice, and training content are derived. Furthermore, the instruction modules, sequence, and the delivery techniques are decided. Following these two phases, the training program is ready to be implemented to trainees. The characteristics of the instructor are important factors in this phase. Finally, evaluation of the training program is emphasized in the improvement phase to make sure that the program works and is up to date.

For training in the organization, Goldstein (1993) states that a systematic approach for the design of a training program should include three phases. The first is the assessment phase. The components of this phase are the assessment of training needs and the derivation of training objectives. The next is the development phase. Training conditions and learning principles are considered in this phase. The last is the evaluation phase. Training effectiveness and validity are evaluated in this phase.

TABLE 15.1 Summary of Systematic Approaches for the Design of Training Programs

Stage	Instructional Psychology (Glaser, 1976; Snow and Swanson, 1992)	Behavioral Learning Theory (Mager, 1988)	Training in Organization (Goldstein, 1993)	Safety Training (OSHA, 1995)
Pretraining stage	Initial state	Analysis	Assessment	Determining if training is needed Identifying training needs Identifying goals and objectives
Training development stage	Training program design Learning process	Development Implementation	Development	Developing learning activities Conducting the training
Post-training stage	Desired state Training effects evaluation	Improvement	Evaluation	Evaluating program effectiveness Improving the program

For safety training, a model with seven guidelines has been suggested by OSHA (1995). These seven training guidelines are: (1) determining if training is needed, (2) identifying training needs, (3) identifying goals and objectives, (4) developing learning activities, (5) conducting the training, (6) evaluating program effectiveness, and (7) improving the program.

Based on time spent in the training process, the training system can be divided into three stages: pretraining stage, training stage, and post-training stage. Each stage has different types of information to convey and different techniques to analyze information. Based on these stages, a summary of systematic training approaches is provided in Table 15.1. Following sections use this classification to present the details in each stage.

Desired Learning Outcomes

In this chapter, the term *learning outcomes* is synonymous with the *learned capabilities* or *trainee's knowledge, skills, and abilities after training*. Generally, learning outcomes include three domains: cognitive, affective, and psychomotor domains (Bloom, Madaus, and Hastings, 1981; Reigeluth and Curtis, 1987; Singer, 1972). Research in the cognitive domain concentrates on intellectual knowledge and skills, studies in the affective domain deal with the trainee's feelings and choices of actions, whereas physical movements and positions are the focus in the psychomotor domain.

Based on different purposes and perspectives, particular taxonomies of learning outcomes have been developed in each domain. However, the first integrated taxonomy which included all three domains was proposed by Gagné (Driscoll, 1994). Gagné (1985) classified all of learning outcomes into five main capabilities: intellectual skills, cognitive strategies, verbal information, motor skills, and attitudes. Any learned capability can be categorized to one or another of these varieties. Since the training strategy employed is a function of the desired learning outcome, a brief discussion is provided to outline the three major categories of learning outcomes. This categorization will be implemented in the review of the literature of training programs in ergonomics. The associated example and domain of learning outcomes for each capability are presented in Table 15.2.

TABLE 15.2 Gagné's Taxonomy of Learning Outcomes

Capability	Example	Domain
Intellectual Skills	Demonstrate how to plan a production schedule.	Cognitive
Verbal Information	State major parts of a product.	Cognitive
Cognitive Strategies	Originate a new production method by invention.	Cognitive
Attitudes	Choose products from certain companies as the benchmarking competitors.	Affective
Motor Skills	Execute an assembly procedure in a production line.	Psychomotor

Adapted from Gagné, R. M. 1985. *The Conditions of Learning and Theory of Instruction*, 4th ed. Holt, Rinehart and Winston, Orlando, FL.

TABLE 15.3 Bloom’s Taxonomy of Learning Outcomes in Cognitive Domain

Knowledge	The recall of specific or general information, ways and means of dealing with this information
Comprehension	The translation, interpretation, and extrapolation of information
Application	The use of information in particular and concrete situations
Analysis	The clarification of the elements, relationships, and organizational principles of information
Synthesis	The development of a plan, a set of operations, or a set of abstract relations
Evaluation	The Judgment in terms of internal and external criteria

Adapted from Bloom, B. S. 1956. *Taxonomy of Educational Objectives: The Classification of Educational Goals*, Handbook 1, *Cognitive Domain*, McKay, New York.

TABLE 15.4 The Summary of the Types of Learning Outcomes in Cognitive Domain

Learning Outcome	Knowledge	Gagné’s Taxonomy	Reigeluth’s Taxonomy	Bloom’s Taxonomy	Merrill’s Taxonomy
Know-What	Declarative	Verbal Information	Conceptual	Knowledge	Remember
Know-How	Procedural	Intellectual Skills Discrimination Concrete concept Defined concept Rule Higher-order rule	Procedural	Comprehension Application Analysis Synthesis Evaluation	Use
Know-Why		Cognitive Strategies	Theoretical		Find

Cognitive Domain

In the cognitive domain, three types of learning outcomes can be found in many studies. That is, the learning outcomes of “know-how,” “know-what,” and “know-why.” For example, the corresponding capabilities in Gagné’s taxonomy are intellectual skills, verbal information, and cognitive strategies. The classification of conceptual, procedural, and theoretical goals in Reigeluth’s Elaboration Theory (ET) also follows this category (Reigeluth and Curtis, 1987). The distinction between procedural and declarative knowledge is associated with the learning outcomes of “know-how” and “know-what” (Driscoll, 1994). Furthermore, the hierarchical categories of learning outcomes can be found in the literature. Bloom (1956) classified the learning outcomes of know-what and know-how into six levels: knowledge, comprehension, application, analysis, synthesis, and evaluation. The description of each level is shown in Table 15.3.

Also, the intellectual skills in Gagné’s taxonomy are divided into five hierarchical levels: discriminations, concrete concepts, defined concepts, rules, and higher-order rules (Gagné, 1985). Moreover, the performance-content matrix in Merrill’s (1983) Component Display Theory provided ten hierarchical combinations of learning outcomes. A summary of these approaches is presented in Table 15.4.

For training programs in ergonomics, the desired learning outcomes of cognitive domain often include the understanding of the musculoskeletal system, the recognition of work-related disorders and risk factors, and the comprehension of ergonomics principles. An introduction of the anatomy and physiology of the musculoskeletal system is frequently suggested and used to enhance trainees’ knowledge of the operation of their bodies (Genaidy, Karwowski, and Mousavinezhad, 1990; Luopajarvi, 1987; Tomer, Olson, and Lepore, 1984; Van Akkerveen, 1985). The statistics of disorders and the description of possible risk factors are provided for the discussion in the training (Genaidy, Karwowski, and Mousavinezhad, 1990; Linton, 1991). Based on the literature in biomechanics, psychophysics, and physiology, ergonomics principles are derived. Principles on the appropriate body mechanics and the adjustment of workload are taught to trainees (Chaffin, Gallay, Woolley, and Kuciembra, 1986; Colombini, Occhipinti, and Menoni, 1993; Davies, 1978; Genaidy, Karwowski, and Mousavinezhad, 1990; Luopajarvi, 1987; Parenmark, Engvall, and Malmkvist, 1988; Snook, 1978; St-Vincent and Tellier, 1989; Tomer, Olson, and Lepore, 1984; Van Akkerveen, 1985).

TABLE 15.5 Taxonomy of Learning Outcomes in Affective Domain

Receiving (Attending)	The awareness, willingness, and controlled or selected attention of receiving certain information
Responding	The acquiescence, willingness, and satisfaction in responding
Valuing	The acceptance, preference, and commitment for a value
Organization	Conceptualization of a value and organization of a value system
Characterization by Value	Generalization and characterization of value sets

Krathwohl, D. R., Bloom, B. S. and Masia, B. B. 1964. *Taxonomy of Educational Objectives: The Classification of Educational Goals*, Handbook 2, *Affective Domain*, McKay, New York.

Affective Domain

For the affective domain, Krathwohl, Bloom, and Masia (1964) classified learning outcomes into five levels: receiving (attending), responding, valuing, organization, and characterization by a value or value complex. The definition for each level is presented in Table 15.5.

Another approach was proposed by integrating the affective domain into the instructional design process (Main, 1992). Keller's ARCS model of motivation for learning was applied in this approach. The ARCS model includes four components: attention, relevance, confidence, and satisfaction, whereas the five instructional design phases are analysis, design, development, implementation, and evaluation. Based on four components of motivation for learning, the affective considerations in each of the instructional design phases can be determined.

This dimension addresses the willingness of the learner to accept and adopt the training methods. This important factor cannot be overlooked in a successful training program. The motivation of the trainees is considered an important criterion in the ergonomic training programs (Luopajarvi, 1987; St-Vincent and Tellier, 1989; Van Akkerveeken, 1985). The characteristics of the instructor and the reaction of the trainees are the key issues in this domain (Linton, 1991; Luopajarvi, 1987).

Psychomotor Domain

From different perspectives, variant dimensions of learning outcomes have been proposed in the psychomotor domain. Task characteristic is one factor to identify the dimensions of learning outcomes in psychomotor domain. Schmidt (1991) classified motor skills according to three dimensions: open–closed, discrete–serial–continuous, and motor–cognitive dimension. An open skill and closed skill are distinguished by their environment. When the environment is variable and unpredictable, the skill is an open skill, such as playing football. On the other hand, when the environment is relatively stable and predictable, the skill is called a closed skill, such as typing. The second dimension is based on the distinction of tasks. A discrete skill has a distinct beginning and end, while there is no particular beginning and end for a continuous skill. A serial skill with discrete actions linked together falls between these two ends of dimension. A similar dimension can also be found in Fitts's taxonomy (Singer, 1972). Finally, the third dimension is defined by involvement of motor skill and cognitive skill. Examples of motor skills are running or jumping, whereas playing chess or controlling a robot are cognitive skills. Other dimensions, such as fine–gross, force–accuracy can be found in Cratty's taxonomy (Singer, 1972). The summary of each dimension and associated example is presented in Table 15.6.

Other factors for the identification of dimensions of learning outcomes are the part of body involved and the type of movement in the execution of actions. Haslegrave (1994) categorized task postures into five parts: head and neck, hand and arm, leg, trunk, and whole body. The three types of movement defined by Haslegrave are duration, repetition, and movement. Similar taxonomies can also be found in the models of Cratty, Guilford, and Fitts (Singer, 1972).

The skills of using proper working postures and the maintenance of physical fitness by means of exercising are the common desired outcomes in this domain for the training program in ergonomics. To gain these working skills, the "learning by doing" approach is the general method (Chaffin, Gallay, Woolley, and Kuciamba, 1986; Genaidy, Karwowski, and Mousavinezhad, 1990; Luopajarvi, 1987; Stubbs, Buckle, Hudson, and Rivers, 1983; Tomer, Olson, and Lepore, 1984).

TABLE 15.6 Summary of Dimension and Example in Psychomotor Domain

Dimension	Example
Open	Playing tennis
Closed	Playing golf
Discrete	Kicking a ball
Serial	Assembly in a production line
Continuous	Driving a car
Motor	Running
Cognitive	Playing chess
Fine	Typing
Gross	Jogging
Accuracy	Darts
Force	Javelin

The following sections of this document will discuss relevant literature which provides the background for assessing the training needs and designing the training system.

Pretraining Stage

During the assessment phase of the training process, three questions must be answered sequentially (OSHA, 1995):

1. Whether training is needed?
2. What training, if any, is needed?
3. What are training goals and objectives?

The preliminary assumption for the first question is that there is a problem to be solved or a desired goal to be achieved. Also, the first question implies that training is not the only means to achieve desired goals. Other methods, such as job redesign or personnel selection, could be considered at the same time.

If the answer to the first question is “yes,” then the following step is to assess training needs and decide training evaluation criteria.

Assessment of Training Needs

McGehee and Thayer (1961) provided a framework with three components of training needs assessment: organization analysis, task analysis, and person analysis. The definitions are as follows:

- Organization analysis: Determining where in the organization training emphasis can and should be placed.
- Task analysis: Determining what should be the training contents in terms of what an employee must do to perform a task, job, or assignment effectively.
- Person analysis: Determining what knowledge, skills, or attitudes an employee must develop for performing his/her job.

Through organization analysis, organizational goals, resources, and the allocation of these resources should be identified. Psychosocial characteristics, such as organization climate, the support from manager, supervisors and peers, must also be assessed (Latham and Crandall, 1991). The support from higher levels of an organization is suggested as an important factor for the effective training program in ergonomics (Kroemer, 1992; Linton, 1991; Tömer, Olson, and Lepore, 1984). Another influential component for the effectiveness of training is the communication between the training designers and trainees (Van Akkerveeken, 1985). The involvement of trainees in the early training design stage usually leads to a successful training program.

In the task analysis, training goals and objectives are specified and the training content is determined. Two essential factors need to be examined in task analysis. One is the complexity of the to-be-learned task, the other is the similarity between the to-be-learned task and previous task. It seems that a better training result is obtained on a simple task rather than a difficult one (Chaffin, Gally, Woolley, and Kuciemba, 1986). With proper analysis, the task demands on knowledge, attitudes, and skills can be determined and the irrelevant training content or the content that trainees have already known can be avoided. Current progress in cognitive engineering provides useful models for the analysis of tasks (Morrison, 1991; Ryder and Redding, 1993). However, task analysis in most ergonomic training programs focuses on the physical aspect such as the working movement patterns and associated musculoskeletal group (Doolittle and Kaiyala, 1991; Parenmark, Engvall, and Malmkvist, 1988).

For the person analysis, the current and desired capabilities in the three learning outcome domains are identified. Research on trainee characteristics has emphasized the trainees' capabilities prior to training as important variables for designing an effective training program (Ackerman and Kyllonen, 1991; Snow and Swanson, 1992). The homogeneity of trainees also needs to be considered. For instance, the training results may be different between experienced workers and newcomers (Parenmark, Engvall, and Malmkvist, 1988). Trainees with various backgrounds of ability and experience may need different training programs. An adaptive training program is suggested to fulfill the different requirements of trainees (Kroemer, 1992; Van Akkerveeken, 1985).

Through the assessment of training needs, the training goals and objectives are characterized, and desired learning outcomes are defined. Objectives are defined as measurable statement of intention, whereas goals are relatively general statements (Mager, 1988). Usually, goals are more abstract and qualitative. To proceed with the training evaluation phase, these goals are transferred to more concrete and quantitative objectives for the selection of training effectiveness criteria.

Criteria of Training Effectiveness Evaluation

According to the training objectives, training effectiveness criteria and training contents are determined in the development phase. The prevalent framework of training effectiveness criteria is Kirkpatrick's (1959) typology with four criteria: reaction, learning, behavior, and results. The definitions of these four training effectiveness criteria are as follows (Kirkpatrick, 1987):

- Reaction: How well did the trainees like the training program?
- Learning: What principles, facts, and techniques were learned? What attitudes were changed?
- Behavior: What changes in job behavior resulted from the training program?
- Results: What were the tangible results of the training program in terms of reduced cost, improved quality, improved quantity, etc.?

For training programs in ergonomics, the reaction of trainees is used as an evaluation criterion (Linton, 1991). The comprehension of the knowledge, attitudes, and skills is the popular area for the evaluation of training effectiveness. Different criteria can be found, such as the knowledge of safety information (Saari, Hryniewiecki, Bédard, Dufort, and Thériault, 1994), the changes of attitudes and behavior (Linton, 1991); and the change of working postures (Genaidy, Karwowski, and Mousavinezhad, 1990; Goggins and Robertson, 1994; Luopajarvi, 1987; St-Vincent and Tellier, 1989). Furthermore, the physiological measurements are used as the criteria of evaluation, for example, the electromyography (EMG) (Parenmark, Engvall, and Malmkvist, 1988) and the intra-abdominal pressure (IAP) (Stubbs, Buckle, Hudson, and Rivers, 1983). Finally, the productivity is considered as the factor. The reduction in cost, the occurrence of work-related disorders, and the absenteeism are applied to be the criteria (Goggins and Robertson, 1994; Snook, 1978; Tomer, Olson, and Lepore, 1984). These criteria are provided for the evaluation of training effectiveness in the post-training stage. The components in the pretraining stage are summarized in Figure 15.3.

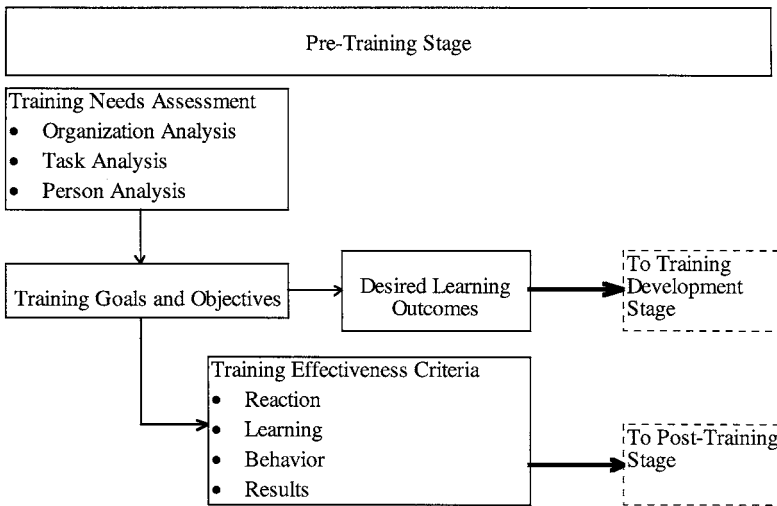

FIGURE 15.3 Components in pretraining stage.

Training Development Stage

The training program is developed and implemented in this stage. Based on the results of the pretraining stage, instructional strategies are applied sequentially to each training activity. Then, the proper training delivery techniques are selected. With the completion of the previous steps, the training program is ready for implementation.

Instructional Strategies

Based on the internal learning processes of trainees, nine corresponding external instructional events are defined (Gagné, 1985). Furthermore, different types of learning outcomes need different instructional strategies to optimize the learning process. The eight instructional steps (Gagné, 1985) are the fundamental elements and are listed below. Note that these are not the steps in developing a training program, but rather, the elements that should exist in a training program.

1. Gaining the attention of the trainee.
2. Preparing the trainee for new information (expectancy).
3. Using recall or transferring from existing experience of the trainee.
4. Presenting the training content.
5. Providing learning guidance or elaboration.
6. Allowing performance and providing feedback.
7. Evaluating performance.
8. Facilitating transfer of the training to actual task performance.

Table 15.7 presents the internal learning processes, the corresponding instructional steps, and the associated instructional strategies.

Training Delivery Techniques

After the instructional steps have been employed, the next step is to select the training delivery techniques. A delivery technique is the combination of media and other resources that will facilitate the delivery of the instruction. Hinrichs (cited by Borman, Peterson, and Russell, 1991) classified delivery techniques into three categories:

TABLE 15.7 Internal Learning Processes, the Corresponding Instructional Events, and the Associated Instructional Strategies

Internal Learning Process	Instructional Event	Instructional Strategy
Reception	1. Gaining attention	Change stimulus
Expectancy	2. Preparing the new information	C: Demonstrate the concepts, rules, procedures, or strategies that trainees will be expected to learn. A: (Trainees are to be informed later). P: Demonstrate the expected motor skills.
Retrieval to Working Memory	3. Recall or transfer of experience	C: Recall the prior knowledge. A: Recall the action choice made in certain situations. P: Recall the skill subroutines.
Selective Perception	4. Presenting training content	C: Describe the content with distinctive features. A: Present general nature of the action choice. P: Display initial situations and executive subroutines.
Semantic Encoding	5. Learning guidance or elaboration	C: Elaborate content by providing examples and using images, mnemonics. A: Demonstrate the action choice made by human model. P: Practice continually.
Responding and Reinforcement	6. Performance and feedback	Ask trainees to perform and provide effective feedback.
Retrieval and Reinforcement	7. Evaluation	Test trainees' performance with feedback.
Retrieval and Generalization	8. Transfer of Training	Enhance practice variety and the number of cues.

Note: C: Cognitive Domain; A: Affective Domain; and P: Psychomotor Domain.

Adapted from Gagné, R. M. 1985. *The Conditions of Learning and Theory of Instruction*, 4th ed. Holt, Rinehart and Winston, Orlando, FL.

TABLE 15.8 Summary of Training Delivery Techniques in Each Learning Domain

Cognitive Domain	Affective Domain	Psychomotor Domain
<ul style="list-style-type: none"> • Manuals or printed instructions • Audiovisual instruction • Lecture • Discussion or conference • Tutoring • On-the-job training • Computer-assisted instruction (CAI) • Case study • Simulations or games 	<ul style="list-style-type: none"> • Discussion or conference • Tutoring • On-the-job training • Case study • Simulations or games • Role playing • Behavior modeling 	<ul style="list-style-type: none"> • On-the-job training • Practice • Coaching • Simulators

1. Content oriented: techniques designed to transmit knowledge on a cognitive level.
2. Process oriented: techniques designed to change attitudes, develop awareness, and enhance interpersonal skills of trainees.
3. Mixed: techniques that combine content-oriented techniques and process-oriented techniques.

In this categorization, content-oriented techniques are appropriate for enhancing cognitive learning outcomes, while affective learning outcomes benefit from process-oriented techniques. For the learning outcomes in the psychomotor domain, some “learning by doing” techniques, such as practice and simulator, are useful. The common training delivery techniques based on the three learning outcome domains are presented in Table 15.8.

For training programs in ergonomics, printed instructions such as handouts and posters are used (Davies, 1978; Colombini, Occhipinti, and Menoni, 1993). Videotape is another tool to facilitate the accomplishment of cognitive learning outcomes (Chaffin, Gallay, Woolley, and Kuciemba, 1986). However, the most common delivery method for cognitive domain is the lecture. The lecture can be in a classroom as well as in the actual workplace. For the desired learning outcomes in affective domain, the

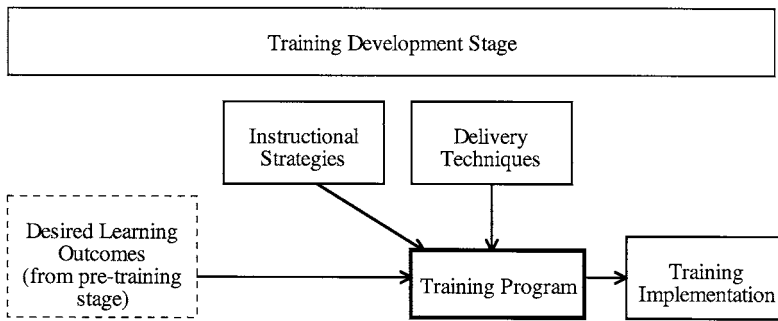

FIGURE 15.4 Components in training development stage.

discussion between the instructor and trainees is the common method for improving the motivation of trainees (Linton, 1991). The stress management course is also used in some training programs (Tomer, Olson, and Lepore, 1984; Van Akkerveeken, 1985). Finally, the achievement of desired psychomotor learning outcomes is usually supported by on-the-job training and practice (Genaidy, Karwowski, and Mousavinezhad, 1990; Luopajarvi, 1987; Tomer, Olson, and Lepore, 1984). Each delivery technique has its strengths and limitations. The choice of delivery techniques depends on the desired training objectives and current state of the trainee's knowledge, attitudes, and skills. For example, lecture is suitable for large audiences, but the audiences are relatively passive and the trainee's attention is difficult to organize (Gordon, 1994).

Training Implementation

There are two major formats of training implementation. One is instructor-controlled, the other is performance-controlled (Mager, 1988). In instructor-controlled format, content-oriented delivery techniques are usually used, and the instructor is the primary resource of information. On the other hand, performance-controlled training is conducted in a self-paced style. According to their capabilities, trainees can decide their learning pace. The instructor does not lead trainees to learn but acts as a coach to support the trainee to learn. Process-oriented delivery techniques are often associated with this format. The instructor-controlled format is the major format for most training programs in ergonomics.

Another important component in this stage is the characteristics of the instructor, especially the characteristics of presentation. In general, the effective instructor should speak clearly and understandably, and provide a positive learning environment (Mager, 1988). For ergonomic training, expertise in the work-related disorders (Tomer, Olson, and Lepore, 1984) and familiarity with the task (Luopajarvi, 1987) are also important for a successful training program. The components of this stage are presented in Figure 15.4. Following this stage, the evaluation of training effectiveness is conducted in the post-training stage.

Post-Training Stage

Training effectiveness evaluation and transfer of training are major issues in this stage. The following sections first provide the theoretical background for effectiveness evaluation and the transfer of training, then the common methods of the evaluation of ergonomic training effectiveness are presented.

Evaluation of Training Effectiveness

According to Salas, Burgess, and Cannon-Bowers (1995), training effectiveness can be defined as: the extent to which training brings desired or appropriate outcomes. Research on instructional psychology defined these "desired or appropriate outcomes" as the "desired state" (Glaser, 1976; Glaser and Bassok, 1989). These desired learning outcomes can be seen as training goals and objectives. When training results match training goals and objectives, the training program can be concluded to be effective. As shown in the pretraining stage, the most popular framework for evaluating training effectiveness is Kirkpatrick's (1959) four criteria.

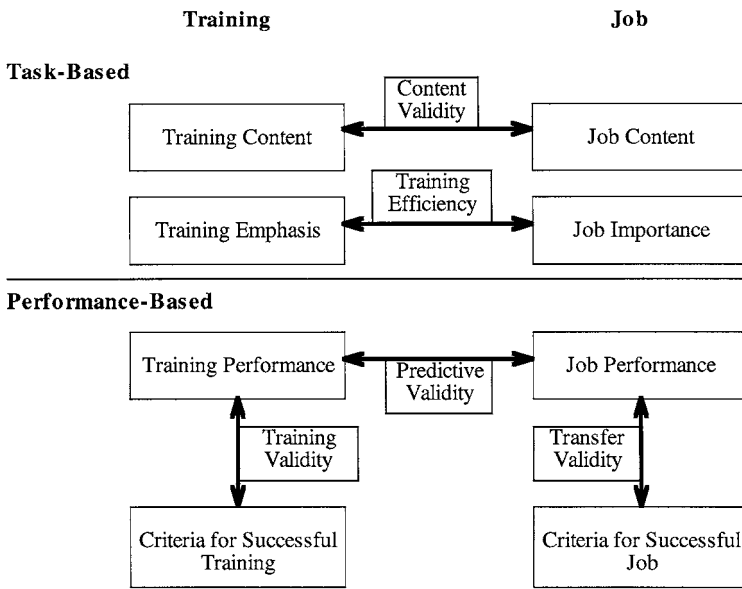

FIGURE 15.5 Relation of purposes of evaluation and information required. (Adapted from Ford, J. K. and Segó, D. 1990. *Linking Training Evaluation to Training Needs Assessment: A Conceptual Model*, Technical Paper, 90-69, Air Force Human Resources Laboratory, Texas.)

When we use criteria to perform the evaluation, criterion reliability, criterion relevancy, criterion deficiency, and criterion contamination must be considered (Goldstein, 1993). Criterion reliability is the consistency of the criteria measures. Criterion relevancy is the degree to which components are identified in training effectiveness and are represented by the criteria. Criterion deficiency is the degree to which components are identified in training effectiveness but are not represented by the criteria. Finally, criterion contamination is the degree to which components are not identified in training effectiveness but are represented by the criteria.

Besides Kirkpatrick's (1959) framework, Ford and Segó (1990) provide a conceptual model for evaluating training effectiveness by linking the purposes of training effectiveness evaluation and the type of information that is required by the evaluation. These five major purposes for conducting training evaluation are: content validity, training efficiency, training validity, transfer validity, and predictive validity. The definitions of these purposes are as follows:

1. Content validity: the relevancy between training content and job.
2. Training efficiency: over- or under-training by the training program.
3. Training validity: the extent of trainees' learning of training material.
4. Transfer validity: trainees' job performance after training.
5. Predictive validity: the prediction of job performance by training performance.

To fulfill these purposes, different types of information are required for different purposes. Ford and Segó (1990) provide two dimensions of information. One is the source of information with two domains: training domain and job domain. The other is the type of information included: task-based (what) and performance-based (how well). The relationship between purposes for conducting training evaluation and their required types of information is presented in Figure 15.5.

Compared to other components in the training system, content validity can be linked to task analysis for training needs assessment in the pretraining stage. Also, training efficiency relates to organization analysis and person analysis for training needs assessment in the pretraining stage. Training validity is similar to the learning component in Kirkpatrick's (1959) category. Finally, transfer validity and predictive validity have derived another important issue: transfer of training.

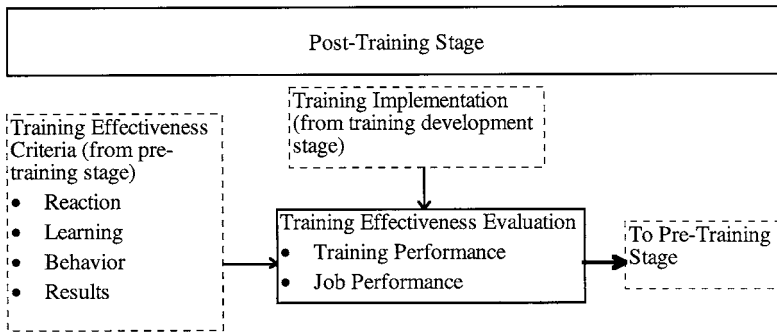

FIGURE 15.6 Components in post-training stage.

Transfer of Training

Transfer of training can be defined as the degree to which trainees effectively apply the knowledge and skills acquired from training to the job (Salas, Burgess, and Cannon-Bowers, 1995). Since training activities are not totally equal to a job, a success in training does not guarantee success in performing the job. Baldwin and Ford (1988) provided two criteria to examine the transfer of training: generalization and maintenance. The definitions of these two criteria are provided as follows:

- Generalization: the degree to which learned knowledge, attitudes, and skills are transferred to the actual job.
- Maintenance: the length of time that learned knowledge, attitudes, and skills continue to be used on the job.

To enhance the transfer of training, trainee characteristics, the training program, and organizational environment must be considered. More details of training evaluation are provided in the next section.

Evaluation Methods for Training Effectiveness

The common evaluation tools are questionnaires, tests, interviews, observation, and performance records (Phillips, 1991). Different methods are suitable for different evaluation purposes. For the criteria related to the desired learning outcomes, tests, interviews, and performance records are adequate for cognitive learning outcomes evaluation. Questionnaires and interviews are the common methods for the evaluation of affective learning outcomes. In psychomotor domain, tests, observation, and performance records are used frequently. In ergonomic training programs, learning outcomes from cognitive and affective domains are usually measured by questionnaires (Linton, 1991; Saari, Hryniewiecki, Bédard, Dufort, and Thériault, 1994), whereas psychomotor learning outcomes are evaluated by using the observation method from videotaping (Genaidy, Karwowski, and Mousavinezhad, 1990) or with a specific observational grid to measure the working postures of trainees (Luopajarvi, 1987; St-Vincent and Tellier, 1989).

For the measurement of physiological factors, special equipment is necessary (Parenmark, Engvall, and Malmkvist, 1988; Stubbs, Buckle, Hudson, and Rivers, 1983). The performance recordings are useful for the evaluation of long-term training effectiveness (Goggins and Robertson, 1994; Snook, 1978; Tomer, Olson, and Lepore, 1984). Figure 15.6 presents components concerned in the post-training stage. The summary of relationships among pretraining stage, training development stage, and post-training stage is presented in Figure 15.7.

15.3 Overview of Literature on Training in Ergonomics

Literature is categorized and reviewed according to the task domain and the evaluation criteria of training effectiveness.

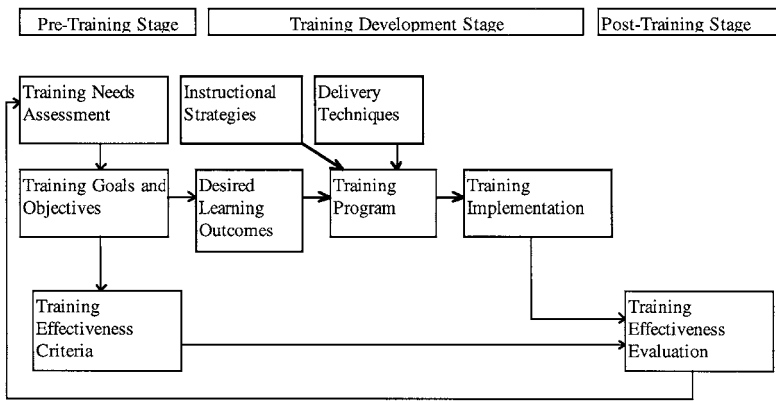

FIGURE 15.7 Components in training system.

Task Domain

For training programs in ergonomics, two task areas have received most attention: the manual handling and VDT-related tasks. In the manual handling task domain, material handling is the most popular area (Chaffin, Galloway, Woolley, and Kuciemba, 1986; Colombini, Occhipinti, and Menoni, 1993; Davies, 1978; Kroemer, 1992; NIOSH, 1981; Snook, 1978), whereas nursing training and patient handling is another focused area (Colombini, Occhipinti, and Menoni, 1993; St-Vincent, Tellier, and Lortie, 1989; Stubbs, Buckle, Hudson, and Rivers, 1983). Regulations and standards for the measurement of capabilities and limitations of workers in manual handling to prevent work-related disorders have been provided over the past two decades. "Training of workers" has become one aspect in *Work Practices Guide for Manual Handling* (NIOSH, 1981).

Since the advance of technology and the expansion of the computer, ergonomic training on VDT-related tasks has been emphasized in recent years (Goggins and Robertson, 1994; Luopajarvi, 1987; Mill, 1994; Robertson, 1994; Pecina and Bojanic, 1993). Standards such as the *American National Standard for Human Factors Engineering of Visual Display Terminal Workstations* (HFS, 1988) have been proposed to provide the standards for a working environment, visual display, keyboard, and furniture. However, training is not included.

Evaluation of Training Effectiveness in Ergonomics

Training effectiveness is the greatest concern in ergonomic training programs. Various criteria are proposed to evaluate the effectiveness of training programs. Based on the measurements of these criteria, a positive result concludes that the training program is effective, but the answer remains unknown for an insignificant result. However, the common conclusion is an unsuccessful training program. Without a systematic framework to guide the selection of evaluation criteria, both claims are questionable and may find an alternative explanation for the result. In this section, the evaluation criteria of previous studies are reviewed based on the conceptual model (Figure 15.1) provided at the beginning of this chapter. This conceptual model was developed specifically for the training in ergonomics to provide a framework for the selection of training evaluation criteria.

As discussed before, the engineering controls always have the priority compared to the administrative controls. Snook's (1978) study is just another confirmation of this statement. With the full examination of approaches of engineering controls, training programs can be developed. In the conceptual model, the causality among work-related disorders, exposure to risk factors, learning outcomes, and the training program is defined. The criteria of evaluation can be the measurements related to the work-related disorders, the exposure to risk factors or the learning outcomes. The reaction and the comprehension of the knowledge, attitudes, and skills are the criteria for measuring the learning outcomes (Genaidy,

Karwowski, and Mousavinezhad, 1990; Goggins and Robertson, 1994; Linton, 1991; Luopajarvi, 1987; Saari, Hryniewiecki, Bédard, Dufort, and Thériault, 1994; St-Vincent and Tellier, 1989). The measurements of physiological factors belong to the exposure to risk factors (Parenmark, Engvall, and Malmkvist, 1988; Stubbs, Buckle, Hudson, and Rivers, 1983). Finally, work records can be the criteria related to the disorders (Goggins and Robertson, 1994; Snook, 1978; Tomer, Olson, and Lepore, 1984).

Usually, it is easier to explain the results when the criteria are related to the learning outcomes. The reason is that there is a closer linkage between the training program and the learning outcomes. However, the disadvantage is the lack of information for the effects on the exposure of risk factors and work-related disorders. On the other hand, criteria for the work-related disorders are most powerful to evaluate the training effectiveness. However, the uncertainty is increased and a long-term evaluation period may be necessary.

15.4 Summary

Although some training approaches have shown positive results, effects of most studies are uncertain and inconsistent (Kroemer, 1992; Kuorinka and Forcier, 1995). To overcome this deficiency, current research suggests that a holistic and systematic approach is essential for effective training (Kroemer, 1992; Kuorinka and Forcier, 1995; Robertson, 1994). In this chapter, a conceptual model for the function of training programs in ergonomics and a systems approach for the design of training programs are proposed to build up a framework for designing an effective training program. In the conceptual model, the work-related disorders can be reduced only because the exposure to associated risk factors has been reduced. That is, work-related disorders are the results of the exposure to their risk factors. From the other side, the training program is designed to support trainees to acquire the desired learning outcomes. In other words, the learning outcomes are the result of ergonomic training programs and are used to reduce the exposure of risk factors. Consequently, the requirement of a successful ergonomic training program is to make sure that there are well-assessed linkages between the training program and learning outcomes, between learning outcomes and risk factors, and between risk factors and work-related disorders. In contrast, the reasons for an unsuccessful ergonomic training program can be the failures of each linkage or of the combination of these linkages. For instance, the trainees may not obtain the desired learning outcomes after the training, the learning outcomes cannot reduce the exposure of risk factors, or the focused risk factors have little contribution to the occurrence of corresponding work-related disorders.

In conclusion, due to the prevalence of work-related disorders and the complexity of problem domain, the design of ergonomic training programs for the prevention of work-related disorders is a significant and rich research area. It is important not only because of the economic aspect, but also the influence on quality of life. Training is not a panacea but just a part of a more global solution for the prevention of work-related disorders (Kuorinka and Forcier, 1995). Other methods such as engineering controls should be considered simultaneously. Moreover, the multidisciplinary approach is needed with the integration of human factors, psychology, education, epidemiology, and pathology to understand the detail structure of the conceptual model provided in this chapter.

References

- Ackerman, P. L. and Kyllonen, P. C. 1991. Trainee characteristics, in *Training for Performance: Principles of Applied Human Learning*, Ed. J. E. Morrison, p. 193-229. John Wiley & Sons Ltd., New York.
- American Academy of Orthopaedic Surgeons. 1992. *Musculoskeletal Conditions in the United States*, AAOS, Park Ridge, IL.
- Baldwin, T. T. and Ford, J. K. 1988. Transfer of training: A review and directions for future research. *Personnel Psychology*. 41: 63-105.
- Bloom, B. S. 1956. *Taxonomy of Educational Objectives: The Classification of Educational Goals*, Handbook 1, *Cognitive Domain*, McKay, New York.
- Bloom, B. S., Madaus, G. F. and Hastings, J. T. 1981. *Evaluation to Improve Learning*, McGraw-Hill, New York.

- Borman, W. C., Peterson, N. G. and Russell, T. L. 1991. Selection, training, and development of personnel, in *Handbook of Industrial Engineering*, 2nd ed. G. Salvendy, p. 882-915. John Wiley & Sons Ltd., New York.
- Chaffin, D. B., Galloway, L. S., Woolley, C. B. and Kuciemba, S. R. 1986. An evaluation of the effect of a training program on worker lifting postures. *International Journal of Industrial Ergonomics*. 1: 127-136.
- Chenoweth, D. 1995. Worksite health promotion and injury, in *Worksite Health Promotion Economics: Consensus and Analysis*, Ed. R. L. Kaman, p. 117-130. Human Kinetics, Champaign, IL.
- Colombini, D., Occhipinti, E. and Menoni, O. 1993. Health education and training for workers involved in manual handling tasks, in *The Ergonomics of Manual Work*, Eds. W. S. Marras, W. Karwowski, J. L. Smith and L. Pacholski, p. 503-506. Taylor & Francis, London.
- Davies, B. T. 1978. Training in manual handling and lifting, in *Safety in Manual Materials Handling*, Ed. C. G. Drury, p. 175-178. NIOSH Publication, No. 78-185, Cincinnati, OH.
- Doolittle, T. L. and Kaiyala, K. 1991. Screening and training as administrative controls, in *Industrial Ergonomics: Case Studies*, Eds. B. M. Pulat and D. C. Alexander, p. 61-73. McGraw-Hill, New York.
- Driscoll, M. P. 1994. *Psychology of Learning for Instruction*, Allyn and Bacon, Boston.
- Ford, J. K. and Sego, D. 1990. *Linking Training Evaluation to Training Needs Assessment: A Conceptual Model*, Technical Paper, 90-69, Air Force Human Resources Laboratory, Texas.
- Ford, J. K. and Wroten, S. P. 1984. Introducing new methods for conducting training evaluation and for linking training evaluation to program redesign. *Personnel Psychology*. 37: 651-665.
- Gagné, R. M. 1985. *The Conditions of Learning and Theory of Instruction*, 4th ed. Holt, Rinehart and Winston, Orlando, FL.
- Gagné, R. M. and Briggs, L. J. 1974. *Principles of Instructional Design*, Holt, Rinehart and Winston, New York.
- Gagné, R. M. and Glaser, R. 1987. Foundations in learning research, in *Instructional Technology: Foundations*, Ed. R. M. Gagné, p. 49-83. Lawrence Erlbaum Associates., Mahwah, NJ.
- Genaidy, A. M., Karwowski, W. and Mousavinezhad, S. H. 1990. Computer-aided ergonomics: A tool for control of musculoskeletal injuries, in *Computer-Aided Ergonomics: A Researcher's Guide*, Eds. W. Karwowski, A. M. Genaidy and S. S. Asfour, p. 18-27. Taylor & Francis, London.
- Glaser, R. 1976. Components of a psychology of instruction: Toward a science of design. *Review of Educational Research*. 46 (1): 1-24.
- Glaser, R. and Bassok, M. 1989. Learning theory and the study of instruction. *Annual Review of Psychology*. 40: 631-666.
- Goggins, R. W. and Robertson, M. M. 1994. The use of instructional systems design and performance analysis to design and evaluate office ergonomics training. *Proceedings of the Human Factors and Ergonomics Society*. 38: 952.
- Goldstein, I. L. 1980. Training in work organizations. *Annual Review of Psychology*. 31: 229-272.
- Goldstein, I. L. 1993. *Training in Organizations*, 3rd ed. Brooks/Cole Publishing, Pacific Grove, CA.
- Gordon, S. E. 1994. *Systematic Training Program Design*, Prentice Hall, Englewood Cliffs, NJ.
- Haslegrave, C. M. 1994. What do we mean by a working posture? *Ergonomics*. 37 (4): 781-799.
- Hedge, J. W., Borman, W. C. and Carter, G. W. 1994. Personnel selection and training, in *Design of Work and Development of Personnel in Advanced Manufacturing*, Eds. G. Salvendy and W. Karwowski, p. 187-218. John Wiley & Sons Ltd., New York.
- HFS 1988. *American National Standard for Human Factors Engineering of Visual Display Terminal Workstations*, ANSI/HFS 100-1988, Human Factors Society, Inc., Santa Monica, CA.
- Holding, D. H. 1991. Transfer of training, in *Training for Performance: Principles of Applied Human Learning*, Ed. J. E. Morrison, p. 93-125. John Wiley & Sons Ltd., New York.
- Kirkpatrick, D. L. 1959. Techniques for evaluating training programs. *Journal of the American Society of Training Directors*. 3: 21-26.
- Kirkpatrick, D. L. 1987. Evaluation, in *Training and Development Handbook*, 3rd ed. R. L. Craig, p. 301-319. McGraw-Hill, New York.

- Krathwohl, D. R., Bloom, B. S. and Masia, B. B. 1964. *Taxonomy of Educational Objectives: The Classification of Educational Goals*, Handbook 2, *Affective Domain*, McKay, New York.
- Kroemer, K. H. E. 1992. Personnel training for safer material handling. *Ergonomics*. 35 (9): 1119-1134.
- Kuorinka, I. and Forcier, L. 1995. *Work Related Musculoskeletal Disorders (WMSDs): A Reference Book for Prevention*, Taylor & Francis, London.
- Latham, G. P. and Crandall, S. R. 1991. Organizational and social factors, in *Training for Performance: Principles of Applied Human Learning*, Ed. J. E. Morrison, p. 259-285. John Wiley & Sons Ltd., New York.
- Linton, S. J. 1991. A behavioral workshop for training immediate supervisors: The key to neck and back injuries? *Perceptual and Motor Skills*. 73: 1159-1170.
- Luopajarvi, T. 1987. Workers' education. *Ergonomics*. 30 (2): 305-311.
- Mager, R. F. 1988. *Making Instruction Work or Skillbloomers*, Lake Publishers, Belmont, CA.
- Main, R. G. 1992. *Integrating the Affective Domain into the Instructional Design Process*, Technical Paper, AL-TP-1992-0004, Technical Training Research Division, Brooks Air Force Base, Texas.
- McGehee, W. and Thayer, P. W. 1961. *Training in Business and Industry*, John Wiley & Sons Ltd., New York.
- Morrison, J. E. 1991. Introduction, in *Training for Performance: Principles of Applied Human Learning*, Ed. J. E. Morrison, p. 1-12. John Wiley & Sons Ltd., New York.
- NIOSH 1981. *A Work Practices Guide for Manual Lifting*, National Institute for Occupational Safety and Health Publication, No. 81-122, Cincinnati, OH.
- OSHA 1995. *Training Requirements in OSHA Standards and Training Guidelines*, Occupational Safety and Health Administration, Washington, D.C.
- Parent, G., Engvall, B. and Malmkvist, A-K. 1988. Ergonomic on-the-job training of assembly workers. *Applied Ergonomics*, 19 (2): 143-146.
- Patrick, J. 1991. Types of analysis for training, in *Training for Performance: Principles of Applied Human Learning*, Ed. J. E. Morrison, p. 127-166. John Wiley & Sons Ltd., New York.
- Pecina, M. M. and Bojanic, I. 1993. *Overuse Injuries of the Musculoskeletal System*, Ed. CRC Press, Boca Raton, FL.
- Pheasant, S. 1991. *Ergonomics, Work and Health*, Aspen Publishers, Gaithersburg, MD.
- Phillips, J. J. 1991. *Handbook of Training Evaluation and Measurement Methods*, 2nd. ed. Gulf Publishing, Houston.
- Reigeluth, C. M. 1992. Elaborating the elaboration theory. *Educational Technology, Research and Development*. 40 (3): 80-86.
- Reigeluth, C. M. and Curtis, R. V. 1987. Learning situations and instructional models, in *Instructional Technology: Foundations*, Ed. R. M. Gagné, p. 175-206. Lawrence Erlbaum Associates, Mahwah, NJ.
- Robertson, M. M. 1994. Designing VDT operator training programs for preventing work-related musculoskeletal disorders. *Proceedings of the Human Factors and Ergonomics Society*. 38: 429-433.
- Ryder, J. M. and Redding, R. E. 1993. Integrating cognitive task analysis into instructional systems development. *Educational Technology, Research and Development*. 41 (2): 75-96.
- Saari, J. Hryniewiecki, J. Bédard, S. Dufort, V. and Thériault, G. 1994. Efficacy of training procedures in implementing a legislated safety program. *Applied Ergonomics*, 25 (2): 116-118.
- Salas, E., Burgess, K. A. and Cannon-Bowers, J. A. 1995. Training effectiveness techniques, in *Research Techniques in Human Engineering*, Ed. J. Weimer, p. 439-475. Prentice-Hall, Englewood Cliffs, NJ.
- Schmidt, R. A. 1991. *Motor Learning and Performance: From Principles to Practice*, Human Kinetics Books, Champaign, IL.
- Singer, R. N. 1972. *The Psychomotor Domain: Movement Behaviors*, Lea and Febiger, Philadelphia.
- Snook, S. H. 1978. The design of manual handling tasks. *Ergonomics*. 21 (12): 963-985.
- Snow, R. E. and Swanson, J. 1992. Instructional psychology: Aptitude, adaptation, and assessment. *Annual Review of Psychology*. 43: 583-626.
- St-Vincent, M. and Tellier, C. 1989. Training in handling: an evaluative study. *Ergonomics*. 32 (2): 191-210.
- Stubbs, D. A., Buckle, P. W., Hudson, M. P. and Rivers, P. M. 1983. Back pain in the nursing profession. II. The effectiveness of training. *Ergonomics*. 26 (8): 767-779.

- Tannenbaum, S. I. and Yukl, G. 1992. Training and development in work organizations. *Annual Review of Psychology*. 43: 399-441.
- Tomer, G. M., Olson, C. N. and Lepore, B. 1984. Back injury prevention training makes dollars and sense. *National Safety News*. Jan.: 36-39.
- Van Akkerveeken, P. F. 1985. Teaching aspects. *Ergonomics*. 28 (1): 371-377.
- Wilson, B. and Cole, P. 1992. A critical review of elaboration theory. *Educational Technology, Research and Development*. 40 (3): 63-79.

Part II
Environmental Issues in
Ergonomics

16

Noise in Industry: Auditory Effects, Measurement, Regulations, and Management

16.1	Introduction	16-1
16.2	Sound and Noise	16-2
	Basic Parameters • Physical Quantification: Sound Levels and the Decibel Scale • Psychophysical Quantification: Loudness Scales	
16.3	Effects of Noise in Occupational Settings.....	16-6
	Nonauditory Effects • Signal Detection and Communications Effects • Noise-Induced Hearing Loss	
16.4	Measurement and Quantification of Noise Exposures.....	16-11
	Basic Instrumentation • Measures for Quantifying Occupational Noise Levels	
16.5	Industrial Noise Regulation and Abatement.....	16-23
	Indicators of the Need for Attention to Noise • Hearing Conservation Programs and the Systems Approach	

John G. Casali

*Virginia Polytechnic Institute and
State University*

Gary S. Robinson

*Virginia Polytechnic Institute and
State University*

16.1 Introduction

The din of noise emanating from industrial processes pervades many occupational settings, and its effects on workers range from minor annoyance to major risk of hearing damage. Unfortunately, at least within the current limits of technology, noise is a by-product of many industries, such as manufacturing, especially those which use high-energy or impact processes such as metal cutting and mineral refinement, and service-related industries, such as air transport, construction, and farming. Workers complain about the negative effects of noise on their abilities to communicate, hear warning and other signals, and concentrate on tasks at hand. However, the effect which has been of most concern to industry has been permanent *noise-induced hearing loss*, or NIHL.

The primary intent of this chapter is to provide an introductory overview of the basic properties, measurement, effects on hearing, government regulations, and abatement of industrial noise, with a particular focus on reducing the physiological damage potential of noise as it impacts the human hearing organ. While the effects of noise exposure are serious and must be reckoned with by the hearing

conservationist or safety professional, one fact is encouraging: process/machine-produced noise is a physical stimulus that can be avoided, reduced, or eliminated; therefore, occupationally related NIHL in workers is completely preventable with effective abatement and protection strategies. Total elimination of NIHL should thus be the only acceptable goal.

16.2 Sound and Noise

Because almost all aspects of hearing conservation and noise abatement in industry rely upon accurate quantification and evaluation of the noise itself, a basic understanding of sound parameters and sound measurement is needed before delving into other noise issues.

Basic Parameters

Sound is a disturbance in a medium (in industry, most commonly air or a conductive structure such as a plant floor) that has mass and elasticity. For example, an industrial metal-forming process wherein a hydraulic ram impacts a plate of sheet metal with great force causes the plate to oscillate or vibrate. Because the plate is coupled to the air medium, it produces a pressure wave that consists of alternating compressions (above ambient air pressure) and rarefactions (below ambient pressure) of air molecules, the *frequency* (f) of which is the number of above/below ambient pressure cycles per second, or *hertz* (Hz). The reciprocal of frequency, $1/f$, is the *period* of the waveform. The waveform propagates outward from the plate as long as it continues to vibrate, and the disturbance in air pressure that occurs in relation to ambient air pressure is heard as sound. The linear distance traversed by the sound wave in one complete cycle of vibration is the *wavelength*. As shown in the following equation, wavelength (λ in meters or feet) depends on the sound frequency (f in Hz) and velocity (c in m/sec or ft/sec; in air at 68°F and pressure of 1 atm, 344 m/sec or 1127 ft/sec) in the medium. The speed of sound increases about 1.1 ft/sec for each increase of 1°F.

$$\lambda = c/f \quad (1)$$

Noise can be loosely defined as a subset of sound; that is, noise is sound that is undesirable or offensive in some aspect. However, the distinction is largely situation- and listener-specific, as perhaps best stated in the old adage “one person’s music is another’s noise.”

Unlike some common ergonomics-related stressors such as repetitive motions or awkward lifting maneuvers, noise is a physical stimulus that is readily measurable and quantifiable using transducers (microphones) and instrumentation (sound level meters) that are commonly available. Aural exposure to noise, and the damage potential therefrom, is a function of the *total energy* transmitted to the ear. In other words, the energy is equivalent to the product of the noise intensity and duration of the exposure. Several metrics which relate to the energy of the noise exposure have been developed, most with an eye toward expressing the exposures that occur in industrial or community settings. These metrics are covered later in this chapter. But first, the most basic unit of measurement must be understood, namely, the *decibel*.

Physical Quantification: Sound Levels and the Decibel Scale

The unit of *decibel*, or 1/10 of a *bel*, is the most common metric applied to the quantification of noise amplitude. The decibel, hereafter abbreviated as dB, is a measure of *level*, defined as the logarithm of the ratio of a quantity to a reference quantity of the same type. In acoustics, it is applied to sound level, of which there are three types.

Sound power level is the most basic quantity, is typically expressed in dB, and is defined as:

$$\text{Sound Power Level in dB} = 10 \log_{10} Pw_1/Pw_r \quad (2)$$

where P_{w_1} is the acoustic power of the sound in Watts, or other power unit; P_{w_r} is the acoustic power of a reference sound in Watts, usually taken to be the acoustic power at hearing threshold for a young, healthy ear at the frequency of maximum sensitivity, or the quantity 10^{-12} Watts.

Sound intensity level, following from power level, is typically expressed in dB, and is defined as:

$$\text{Sound Intensity Level in dB} = 10 \log_{10} I_1/I_r \quad (3)$$

where I_1 is the acoustic intensity of the sound in Watts/m^2 or other intensity unit; I_r is the acoustic intensity of a reference sound in Watts/m^2 , usually taken to be the acoustic intensity at hearing threshold, or the quantity 10^{-12} Watts/m^2 .

Within the last decade, sound measurement instruments to measure sound intensity level have become commonplace, albeit expensive and relatively complex. Sound power level, on the other hand, is not directly measurable but can be computed from empirical measures of sound intensity level or sound pressure level.

Sound pressure level (SPL) is also typically expressed in dB. Since power is directly proportional to the square of the pressure, SPL is defined as:

$$\text{SPL in dB} = 10 \log_{10} P_1^2/P_r^2 = 20 \log_{10} P_1/P_r \quad (4)$$

where P_1 is the pressure level of the sound in microPascals (μPa), or other pressure unit; P_r is the pressure level of a reference sound in μPa , usually taken to be the pressure at hearing threshold, or the quantity $20 \mu\text{Pa}$, or 0.00002 Pa . Other equivalent reference quantities are: $0.0002 \text{ dynes/cm}^2$, $20 \mu\text{Newtons/m}^2$, and $20 \mu\text{bars}$.

The application of the decibel scale to acoustical measurements yields a convenient means of collapsing the vast range of sound pressures which would be required to accommodate sounds that can be encountered into a more manageable, compact range. As shown in Figure 16.1, using the logarithmic compression produced by the decibel scale, the range of typical sounds is 120 decibels, while the same range measured in pressure units (Pa) would be 1,000,000. Of course, sounds do occur that are higher than 120 dB (for instance, artillery fire) or lower than 0 dB (below normal threshold on an audiometer). A comparison of decibel values of example sounds to their pressure values (in Pa) is also depicted in Figure 16.1.

In considering changes in sound level measured in decibels, a few numerical relationships emanating from the above decibel formulae are often helpful in practice. An increase (decrease) in SPL by 6 dB is equivalent to a doubling (halving) of the sound pressure. Similarly, on the power or intensity scales, an increase (decrease) of 3 dB is equivalent to a doubling (halving) of the sound power or intensity. This latter relationship gives rise to what is known as the “equal energy rule or trading relationship.” Because sound represents energy which is itself a product of intensity and duration, an original sound which increases (decreases) by 3 dB is equivalent in total energy to the same original sound which does not change in decibels but decreases (increases) in its duration by half (twice).

Psychophysical Quantification: Loudness Scales

While the decibel is useful for quantifying the amplitude of a sound on a physical scale, it does not yield an absolute or relative basis for quantifying the human perception of sound amplitude, commonly called loudness. However, there are several psychophysical scales which are useful for measuring loudness, the two most prominent being *phons* and *sones*.

Phons

The decibel level of a 1,000 Hz tone which is judged by human listeners to be equally loud to a sound in question is the phon level of the sound. The phon levels of sounds of different intensities are shown in the top panel of Figure 16.2; this family of curves is referred to as the *equal loudness contours*. On any given curve, the combinations of sound level and frequency along the curve produce sound experiences

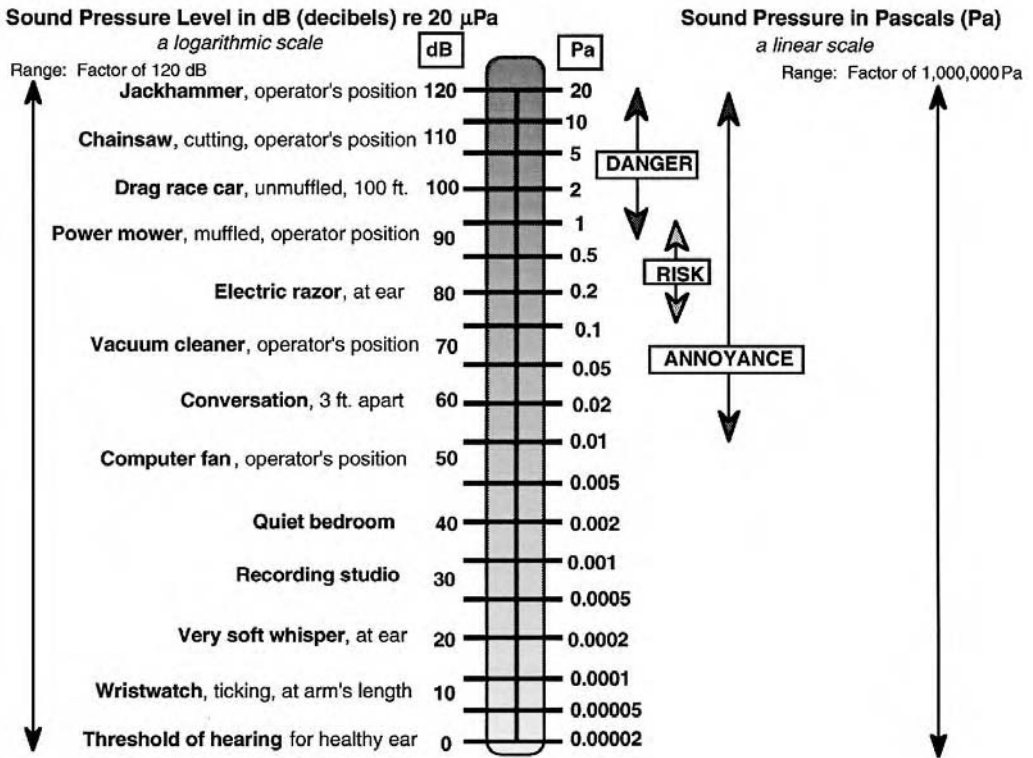

FIGURE 16.1 For typical sounds, sound pressure level values in dB and sound pressure values in Pascals.

of equal loudness to the normal-hearing listener. Note that at 1,000 Hz on each curve the phon level is equal to the dB level. The threshold of hearing for a young, healthy ear is represented by the 0 phon level curve. The young, healthy ear is sensitive to sounds between about 20 and 20,000 Hz, although, as shown by the curve, it is not equally sensitive to all frequencies. At low- and mid-level sound intensities, low frequency and to a lesser extent high frequency sounds are perceived as less intense than sounds in the 1,000 to 4,000 Hz range, where the undamaged ear is most sensitive. But as phon levels move to higher values, the ear becomes more linear in its loudness perception for sounds of different frequencies.

Because the ear exhibits this nonlinear behavior, several frequency weighting functions have been standardized for use with sound level meters. The most common curves are the A, B, and C curves, with the corresponding dB measurement denoted as dBA, dBB, and dBC, respectively. If no weighting function is selected on the meter, the notation dB or dB(linear) is used, and all frequencies are processed without weighting factors. The actual weighting functions for the three suffix notations A, B, and C are superimposed on the phon contours of the top panel of Figure 16.2, and also depicted as actual frequency weighting functions in the bottom panel. In nearly all U.S. measurements of industrial noise made for assessment of exposure risk to workers, the dBA scale is used, and the meter is set on the "slow" dynamic response setting, which produces slow exponential averaging of a one-second window. For determination of the adequacy of hearing protection for a particular noise, and for application of noise control measures, the C-weighted level is often taken in addition to the A-weighted level.

Sones

While the phon scale provides the ability to equate the loudness of sounds of different frequencies, it does not afford an ability to describe how much louder one sound is compared with another. For this, the *sones* scale is needed (Stevens, 1936).¹ One sone is defined as the loudness of a 1,000 Hz tone of 40 dB SPL. In relation to one sone, two sones are twice as loud, three sones are three times as loud, one-half

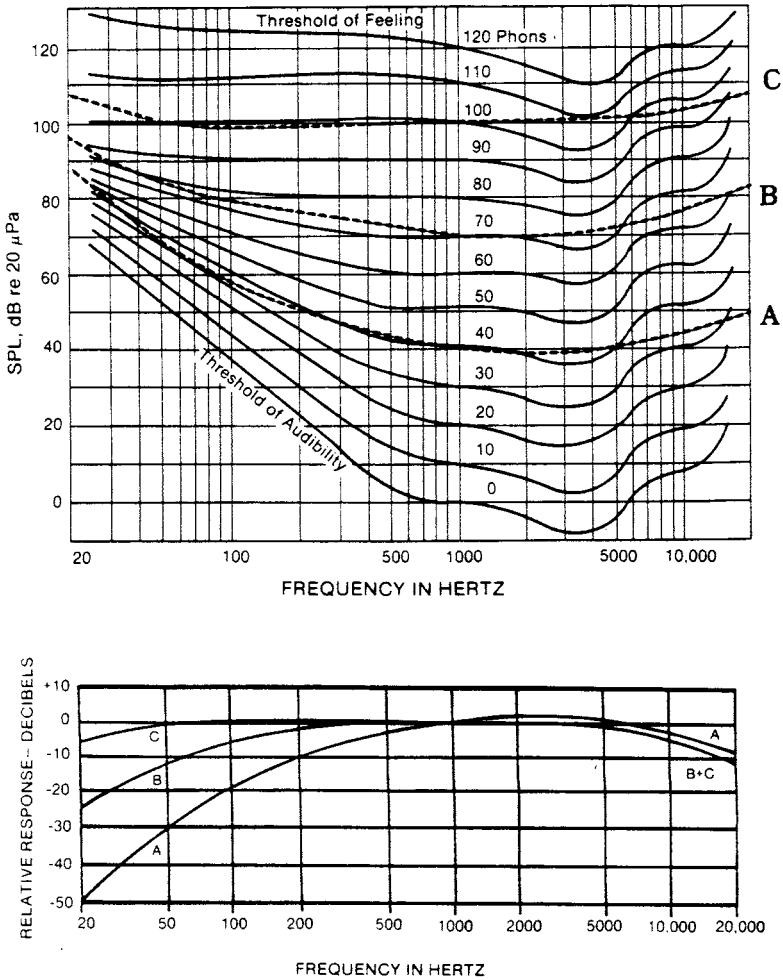

FIGURE 16.2 Top: Equal loudness contours based on the psychophysical phon scale, with sound level meter frequency weighting curves superimposed. Bottom: dB vs. frequency values of A, B, and C sound level meter weighting curves. (Adapted from Earshen, J. J. [1986]. Sound measurement: Instrumentation and noise descriptors, in E. H. Berger, W. D. Ward, J. C. Morrill, and L. H. Royster [Eds.], *Noise and Hearing Conservation Manual* [pp. 38-95]. Akron, OH: American Industrial Hygiene Association. With permission.)

one is half as loud, and so on. Phon level (L_p) and sones are related by the following formula for sounds at or above a 40 phon level:

$$\text{Loudness in Sones} = 2^{\frac{(L_p - 40)}{10}} \tag{5}$$

According to formula 5, 1 sone equals 40 phons and the number of sones doubles with each 10-phon increase; therefore, it is straightforward to conduct a comparative estimate of loudness levels of sounds with different decibel levels. The “rule-of-thumb” is that each 10 dB increase in a sound (that is, one which is above 40 dB to begin with) will result in a doubling of its loudness. For instance, a conference room which is at 45 dBA may currently be comfortable for communication. However, if a new ventilation system increases the noise level in the room by 10 dBA, the occupants will experience a doubling of loudness and will likely complain about the effects of the background noise on conversation in the room.

Once again, the compression effect of the dB scale yields a measure which does not reflect the much larger influence that an increase in sound level will have on the human perception of loudness. Although the sone scale is not widely used (one exception is that household ventilation fans typically have voluntary sone ratings), it is a very useful scale for comparing different sounds as to their perceived loudness.

It should be evident that phon levels can be calculated directly from psychological measurements in sones, but not from physical measurements of SPL in decibels. This is because the phon-based loudness and SPL relationship changes as a function of the sound frequency and the magnitude of this change depends on the intensity of the sound.

Modifications of the Sone

A modification of the sone scale (*Mark VI* and subsequently, *Mark VII sones*) was proposed by Stevens (1972)² to account for the fact that most real sounds are more complex than pure tones. Utilizing the general formula below, Steven's method utilizes octave band, 1/2 octave band, or 1/3 octave band noise measurements, and adds to the sone value of the most intense frequency band a fractional portion of the sum of the sone values of the other bands (ΣS). S_m is the maximum sone value in any band, and k is a fractional multiplier that varies with bandwidth (octave, $k = 0.3$; 1/2 octave, $k = 0.2$; 1/3 octave, $k = 0.15$).

$$\text{Loudness in Sones} = S_m + k(\Sigma S - S_m) \quad (6)$$

Zwicker's Method

The concept of the *critical band for loudness* formed the basis for Zwicker's method of loudness quantification (Zwicker, 1960).³ The critical band is the frequency band within which the loudness of a band of continuously distributed sound of equal SPL is independent of the width of the band. The critical bands widen as frequency increases. A graphical method is used for computing the loudness of a complex sound based on critical band results obtained and graphed by Zwicker. The noise spectrum is plotted and lines are drawn to depict the spread of masking effect (defined later in this chapter). The result is a bounded area on the graph which is proportional to total loudness. The method is relatively complex and the reader may wish to consult Zwicker (1960)³ for computational detail.

Noisiness Units

Loudness and noisiness are related but not synonymous. Noisiness can be defined as the "subjective unwantedness" of a sound. Perceived noisiness may be influenced by a sound's loudness, tonality, duration, impulsiveness, and variability (Kryter, 1994).⁴ Whereas a low level of loudness might be perceived as enjoyable or pleasing, even a low level of unwantedness, that is, noisiness, is by definition undesirable. Equal noisiness contours, analogous to equal loudness contours, have been developed based on a unit (analogous to the phon) called the *perceived noise level* (PN_{dB}), which is the SPL in dB of a 1/3 octave band of random noise centered at 1,000 Hz which sounds equally noisy to the sound in question. Also, an *N-* (later *D-*) sound level meter weighting curve was developed for measuring the perceived noise level of a sound. A subjective noisiness unit analogous to the sone, the *noy*, is used for comparing sounds as to their relative noisiness. One *noy* is equal to 40 PN_{dB} , and two *noys* are twice as noisy as one, five *noys* are five times as noisy, and so on. Similar to the behavior of sone values for loudness, an increase of about 10 PN_{dB} is equivalent to a doubling of the perceived noisiness of a sound.

16.3 Effects of Noise in Occupational Settings

Nonauditory Effects

Noise exposure in industry has been linked to several deleterious effects, some of which are nonauditory and thus beyond the scope of this chapter. However, it is at least important to recognize that noise can degrade operator task performance. Research studies concerning the effects of noise on performance are

primarily laboratory-based and task/noise specific; therefore, extrapolation of the results to actual industrial settings is somewhat risky (Sanders and McCormick, 1993).⁵ Nonetheless, on the negative side, noise is known to mask task-related acoustic cues, as well as cause distraction and disruption of “inner speech,” while on the positive, noise may at least initially heighten operator arousal and thereby improve performance on tasks which do not require substantial cognitive processing (Poulton, 1978).⁶ To obtain reliable effects of noise on performance, except on tasks which rely heavily on short-term memory, the level of noise must be fairly high, usually 95 dBA or greater. Tasks which are simple and repetitive often show no deleterious performance effects (and sometimes improvements) in the presence of noise, while difficult tasks that rely on perception and information processing on the part of the operator will often exhibit performance degradation (Sanders and McCormick, 1993).⁵ It is generally accepted that unexpected or aperiodic noise causes greater degradation than predictable, periodic, or continuous noise, and that the startle response created by sudden noise can be disruptive.

Furthermore, noise has been linked to physiological problems other than those of the hearing organ, including hypertension, heart irregularities, extreme fatigue, and digestive disorders. Most physiological responses of this nature are symptomatic of stress-related disorders. Because the presence of high noise levels often induces other stressful feelings (such as sleep disturbance and interference with conversing in the home, and fear of missing oncoming vehicles or warning signals on the job), there are second-order effects of noise on physiological functioning that are difficult to predict.

Signal Detection and Communications Effects

Interference and the Signal-to-Noise Ratio

One of the most noticeable effects of noise is its interference with speech communications and the hearing of nonverbal signals. Workers often complain that they must shout to be heard and that they cannot hear others trying to communicate with them. Likewise, noise interferes with the detection of workplace signals such as alarms for general area evacuation and warnings, annunciators, on-equipment alarms, and machine-related sounds which are relied upon for feedback. The ratio (actually the algebraic difference) of the speech or signal level to the noise level, termed the *signal-to-noise ratio* (S/N) is the most critical parameter in determining whether speech or signals will be heard in noise. An S/N of 5 dB means that the signal is 5 dB greater than the noise, while an S/N of -5 dB means that the signal is 5 dB lower than the noise. Hearing protection is often blamed for exacerbating the effects of noise on the audibility of speech and signals, although, at least for individuals with normal hearing, protectors may actually facilitate hearing in some noisy situations, particularly those above about 90 dBA.

Masking

Masking is technically defined as the tendency for the threshold of a desired signal or speech (*the masked sound*) to be raised in the presence of an interfering sound (*the masker*). As an example, in the presence of a noisy airport waiting area, a pay telephone's earphone volume must often be increased to enable the listener to hear the party on the line, whereas a lower volume will be more comfortable while affording audibility when there is no crowd or public address system noise present. The *masked threshold* is defined as the SPL required for 75% correct detection of a signal when that signal is presented in a two-interval task wherein, on a random basis, one of the two intervals of each task trial contains the signal and the noise and the other contains only noise. In a controlled laboratory test scenario, a signal that is about 6 dB above the masked threshold will result in near perfect detection performance (Sorkin, 1987).⁷ Analytical prediction (as opposed to actual experimentation with human subjects) of the interfering effects of noise on speech communications may be conducted using the Articulation Index (AI) technique defined in ANSI S3.5-1969 (R1986).⁸ Essentially, this relatively complex technique utilizes a weighted sum of the speech-to-noise ratios in specified frequency bands to compute an AI score ranging between 0.0 and 1.0, with higher scores indicative of greater predicted speech intelligibility. Nonverbal signal detectability predictions can also be made analytically, with the most comprehensive computational technique, based on a spectral analysis of the noise, appearing in ISO 7731-1986.⁹ While a full discussion

of these analytical procedures is beyond the scope of this chapter, the reader is referred to the individual ANSI and ISO standards for detail. The AI and masked threshold computational techniques provide better resolution and accuracy for speech intelligibility and signal detectability predictions than a simple evaluation of broadband S/N ratios because the techniques incorporate the frequency-specific information that simple S/N ratios do not reflect. However, the following general principles regarding masking effects on nonverbal signals and speech can be used for general guidance.

1. The greatest increase in masked threshold occurs for nonverbal signal frequencies which are equal or near to the predominant frequencies of the masking noise; this is called *direct masking*. Therefore, warning signals should not utilize tonal frequencies equivalent to those of the masker. Preferably, the signal should be in the most sensitive range of human hearing, approximately 1,000 to 4,000 Hz, unless the noise energy is intense at these frequencies.
2. If the signal and masker are tonal in nature, the primary masking effect is at the fundamental frequency of the masker and at its harmonics. For instance, if a masking noise has primary frequency content at 1,000 Hz, this frequency and its harmonics (2,000, 3,000, 4,000, etc.) should be avoided as signal frequencies.
3. The greater the SPL of the masker, the more the increase in masked threshold of the signal. A general rule-of-thumb is that the S/N ratio at the listener's ear should at a minimum be about 15 dB above masked threshold for reliable signal detection. However, in noise levels above about 80 dBA, the signal levels required to maintain an S/N ratio of 15 dB above masked threshold may increase the hearing exposure risk, especially if signal presentation occurs frequently. Therefore, if lower S/Ns become necessary, it is best to construct signals which are unlike the masker in frequency and which have modulated or alternating frequencies to grab attention.
4. Warning signals should not exceed the masked threshold by more than 30 dB to avoid verbal communications interference and operator annoyance (Sorkin, 1987).⁷
5. As the SPL of the masker increases, the primary change in the masking effect is that it spreads upward in frequency, often causing signal frequencies which are higher than the masker to be missed. This is termed *upward masking*. Since most warning signal guidelines recommend that the midrange and high-frequency signals (about 1,000 to 4,000 Hz) be used for detectability, it is important to consider that the masking effects of industrial noise of lower frequencies can spread upward and cause interference in this range. Therefore, if the noise has its most significant energy in this range, a lower frequency signal, say 500 Hz, may be necessary. However, it must be kept in mind that the ear is not as sensitive to low frequencies, so the signal level must be carefully set to ensure reliable audibility.
6. Masking effects can also spread downward in frequency, causing signal frequencies below those of the masker to be raised in threshold. This is called *remote masking* and the effect is most prominent at signal frequencies which are subharmonics of the masker. With typical industrial noise sources, remote masking is generally less of a problem than direct or upward masking.
7. In extremely loud environments of about 110 dB and above, nonauditory signal channels such as visual and vibro-tactile should be considered as alternatives to auditory displays.
8. Speech intelligibility in noise depends on a combination of complex factors and, as such, predictions based on simple S/N ratios should not be relied upon. However, in very general terms, S/N ratios of 15 dB or higher should result in intelligibility performance above about 80% words correct for normal-hearing individuals in broadband noise (Acton, 1970).¹⁰ Above speech levels of about 85 dBA, there is some decline in intelligibility even if S/N ratio is held constant (Pollack, 1958).¹¹ In very high noise levels, it is impractical and may pose additional hearing hazard risk to amplify the voice to maintain the high S/N ratios necessary for good intelligibility performance. The S/N ratio required for reliable intelligibility may be reduced via the use of certain techniques such as reduction of speaker-to-listener distances, use of smaller vocabularies, provision of contextual cues in the message, use of the phonetic alphabet, and use of noise-attenuating headphones and noise-canceling microphones in electronic systems.

9. Electronic speech communications systems should reproduce speech frequencies in the range of 500 to 5,000 Hz, which encompasses the most sensitive range of hearing and includes the speech sounds important for message comprehension. More specifically, because much of the information required for word discrimination lies in the consonants, which are in the higher end of the frequency range and of low power (while the power of the vowels is in the peaks of the speech waveform), the use of electronic peak-clipping and reamplification of the waveform may improve intelligibility because the power of the consonants is thereby boosted relative to the vowels. Furthermore, it is critical that frequencies in the region of 1,000 to 4,000 Hz be faithfully reproduced in electronic communication systems to maintain intelligibility. Filtering out of frequencies outside this range will not appreciably affect word intelligibility, but will influence the quality of the speech.
10. Actual human speech results in higher intelligibility in noise than computer-generated speech; therefore, especially for critical message displays and annunciators, live, recorded, or digitized human speech is preferable over synthesized speech (Morrison and Casali, 1994).¹²

Noise-Induced Hearing Loss

Scope of Hearing Loss in the U.S.

Noise-induced hearing loss (NIHL) is one of the most widespread occupational maladies in the U.S., if not the world. In the early 1980s, it was estimated that over 9 million workers are exposed to noise levels averaging over 85 dBA for an 8-hour workday (EPA, 1981).¹³ Today, this number is likely to be higher because the control of noise sources, both in type and number, has not kept pace with the proliferation of industrial and service sector development. Due in part to the fact that before 1971 there were no U.S. federal regulations governing noise exposure in general industry, many workers over 50 years of age now exhibit hearing loss that results from the effects of occupational noise. Of course, the total noise exposure from both occupational and nonoccupational sources determines the NIHL that a victim experiences. Of the estimated 28 million Americans who exhibit significant hearing loss due to a variety of etiologies, such as pathology of the ear, ototoxic drugs, and hereditary tendencies, over 10 million have losses which are directly attributable to noise exposure (NIH, 1990).¹⁴ Therefore, the noise-related losses are preventable in nearly all cases. The majority of losses are due to on-the-job exposures, but leisure noise sources do contribute a significant amount of energy to the total noise exposure of some individuals.

Types and Etiologies of Noise-Induced Hearing Loss

Although the major concern of the industrial hearing conservationist is to prevent employee hearing loss that stems from occupational noise exposure, it is important to recognize that hearing loss may also emanate from a number of sources other than noise, including: infections and diseases specific to the ear, most frequently originating in the middle or conductive portion; other bodily diseases, such as multiple sclerosis which injures the neural part of the ear; ototoxic drugs, of which the mycin family is a prominent member; exposure to certain chemicals and industrial solvents; hereditary factors; head trauma; sudden hyperbaric- or altitude-induced pressure changes; and aging of the ear (presbycusis). Furthermore, not all noise exposure occurs on the job. Many workers are exposed to hazardous levels during leisure activities, from such sources as automobile/motorcycle racing, personal stereo headsets and car stereos, firearms, and power tools. The effects of noise on hearing are generally subdivided into the following three categories (Melnick, 1991).¹⁵

Acoustic Trauma

Immediate organic damage to the ear from an extremely intense acoustic event such as an explosion is known as *acoustic trauma*. The victim will notice the loss immediately and it often constitutes a permanent injury. The damage may be to the conductive chain of the ear, including rupture of the eardrum or dislodging of the ossicles (small bones) of the middle ear. Conductive losses can, in many cases, be compensated for with a hearing aid and/or surgically corrected. Neural damage may also occur, involving a dislodging of the hair cells and/or breakdown of the neural organ (Organ of Corti) itself. Unfortunately,

neural loss is irrecoverable and not typically compensable with a hearing aid. Acoustic trauma represents a severe injury, but fortunately its occurrence is uncommon, including in the industrial setting.

Noise-Induced Threshold Shift

A *threshold shift* is defined as an elevation of hearing level from the individual's baseline hearing level and it constitutes a loss of hearing sensitivity. *Noise-induced temporary threshold shift* (NITTS), sometimes referred to as "auditory fatigue," is by definition recoverable with time away from the noise. The elevation of threshold is temporary, and usually can be traced to an overstimulation of the neural hair cells (actually, the stereocilia) in the Organ of Corti. Although the individual may not notice the temporary loss of sensitivity, NITTS is a cardinal sign of overexposure to noise. It may occur over the course of a full workday in noise or even after a few minutes of exposure to very intense noise. Although the relationships are somewhat complex and individual differences are rather large, NITTS does depend on the level, duration, and spectrum of the noise, as well as the audiometric test frequency in question (Melnick, 1991).¹⁵

Prevention of *noise-induced permanent threshold shift* (NIPTS), for which there is no possibility of recovery, is the primary target of the industrial hearing conservationist. NIPTS can manifest suddenly as a result of acoustic trauma; however, industrial noise problems that cause NIPTS most typically constitute exposures that are repeated over a long period of time and have a cumulative effect on hearing sensitivity. In fact, the losses are often quite insidious in that they occur in small steps over a number of years of overexposure and the worker is not aware of the problem until it is too late. This type of exposure produces permanent neural damage, and although there are some individual differences as to magnitude of loss and audiometric frequencies affected, the typical pattern for NIPTS is a prominent elevation of threshold at the 4,000 Hz audiometric frequency (sometimes called the 4 kHz notch), followed by a spreading of loss to adjacent frequencies of 3,000 and 6,000 Hz. From a classic study on workers in the jute weaver industry, Figure 16.3 depicts the temporal profile of NIPTS as the family of audiometric threshold shift curves, with each curve representing a different number of years of exposure (Taylor, Pearson, Mair, and Burns, 1964).¹⁶ As noise exposure continues over time, the hearing loss will spread over a wider frequency bandwidth inclusive of midrange and high frequencies, and encompassing the range of most auditory warning signals. In some cases, the hearing loss renders it unsafe or unproductive for the victim to work in certain occupational settings where the hearing of certain signals is requisite to the job. Unfortunately, the power of the consonants of speech sounds, which heavily influence the intelligibility of human speech, also lie in the frequency range that is typically affected by NIPTS, compromising the victim's ability to understand speech. This is the tragedy of NIPTS in that the worker's ability to communicate is hampered, often severely and always irrecoverably. Furthermore, unlike blindness or many physical disabilities, hearing loss is not overt and therefore often goes unrecognized by others. Thus, it is a particularly isolating disability because the victim is unintentionally excluded from conversations and may miss important auditory signals because others are either unaware of the loss or simply forget about the need to compensate for it.

Concomitant Auditory Maladies

Following exposure to high-intensity noise, some individuals will notice that ordinary sounds are perceived as "muffled," and in some cases, they may experience a ringing or whistling sound in the ears, known as *tinnitus*. These manifestations should be taken as serious indications that overexposure has occurred, and that protective action should be taken if similar exposures are encountered in the future. Tinnitus may also occur by itself or in conjunction with NIPTS, but in any case it is thought to be the result of *otoacoustic emissions*, which are essentially acoustic outputs from the inner ear that are audible to the victim, apparently resulting from mechanical activity or *microphonics* of the neural cells. Some individuals report that tinnitus is always present, pervading their lives. It thus has the potential to be quite disruptive and in severe cases, debilitating.

More rare than tinnitus, but typically quite debilitating is the malady known as *hyperacusis*, which refers to hearing that is extremely sensitive to sound. Hyperacusis can manifest in many ways, but a number of victims report that their hearing became painfully sensitive to sounds of even normal levels

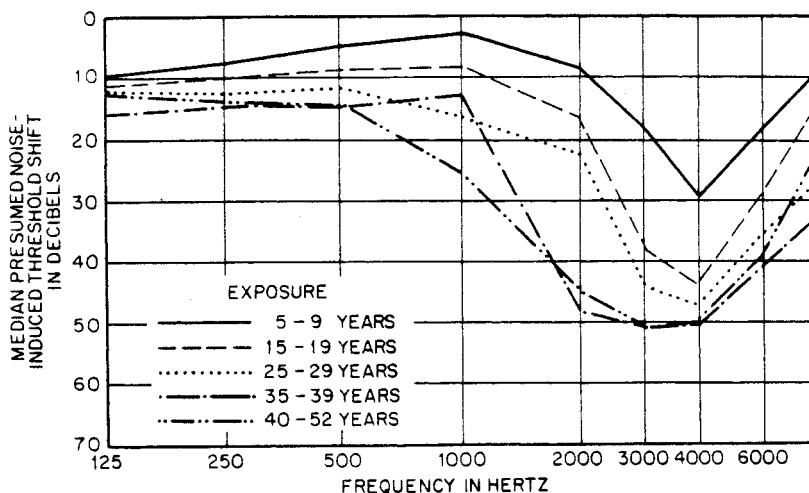

FIGURE 16.3 Cumulative auditory effects of years of noise exposure in a jute weaving industry. (Adapted from Taylor, W., Pearson, J., Mair, A. and Burns, W. [1964]. Study of noise and hearing in jute weavers. *Journal of the Acoustical Society of America*, 38, 113-120. With permission.)

after exposure to a particular noise event. Therefore, at least for some, hyperacusis can be directly traced to noise exposure. Sufferers typically must use hearing protectors when performing normal activities, such as walking on city streets, visiting movie theaters, or washing dishes in a sink, because such activities produce sounds which are painfully loud to them. It should be noted that hyperacusis sufferers often exhibit normal audiograms; that is, their thresholds are not typically better than those of “normal hearers,” even though their reaction to sound is one of hypersensitivity.

It is important that the industrial hearing conservationist be aware of these hearing-related maladies that may or may not arise as a result of on-the-job noise exposure, but which may influence the worker’s ability to perform certain jobs or work in certain environments.

16.4 Measurement and Quantification of Noise Exposures

Basic Instrumentation

Measurement and quantification of sound exposure levels provide the fundamental data for assessing hearing exposure risk, speech and signal masking effects, hearing conservation program needs, and engineering noise control strategies. A vast array of instrumentation is available for sound measurement; however, for monitoring and assessment of most noise exposure situations, a basic understanding of three primary instruments (sound level meters, dosimeters, and real-time spectrum analyzers) and their data output will suffice. In instances where noise is highly impulsive in nature and/or selection and development of situation-specific engineering noise control solutions is anticipated, more specialized instruments may be necessary.

Because sound is propagated as pressure waves which vary over space and in time, a complete quantification would require simultaneous measurements over the continuous time periods (representing complete operator exposure durations) at all points of an occupational sound field to exhaustively document the noise level in the space. Clearly, this is typically cost- and time-prohibitive, so one must resort to sampling strategies for establishing the observation points and intervals. The hearing conservationist must also decide whether detailed, discrete time histories are needed (such as with a noise-logging *dosimeter*, discussed later), if averaging over time and space with long data records is required (with an averaging/integrating dosimeter), whether discrete samples taken with a short-duration moving

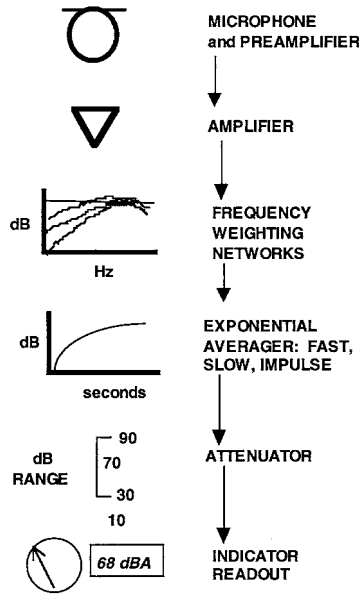

FIGURE 16.4 Block diagram of the basic functional components of a sound level meter.

time average (with a basic sound level meter) will suffice, or if frequency-band-specific SPLs are needed for selecting noise abatement materials (with a spectrum analyzer). Following is a brief discussion of the three primary types of sound measurement instruments and the noise descriptors that can be obtained therefrom.

Sound Level Meter

Most sound measurement instruments derive from the basic sound level meter (SLM), a device for which four grades (and associated performance tolerances that become less stringent as the grade number increases) are described in ANSI S1.4-1983 (R1994).¹⁷ Type 0 instruments have the most stringent tolerances and are for laboratory use only. Other grades include Type 1, intended for precision measurement in the field or laboratory, Type 2, intended for general field use, especially where frequencies above 10,000 Hz are not prevalent, and Type S, a special purpose meter which may perform at grades 0 through 2, but may not include all of the operational functions of the grade. A grade of Type 2 or better is needed for occupational exposure measurements.

Components of a Sound Level Meter

A block diagram of the functional components of a generic SLM appears in Figure 16.4. At the top, a microphone/preamplifier senses the pressure changes caused by an airborne sound wave and converts the pressure signal into a voltage signal. Because the pressure fluctuations of a sound wave are small in magnitude, the corresponding voltage signal must be preamplified and then input to an amplifier which boosts the signal before it is processed further. The passband, or range of frequencies which are passed through and processed, of a high-quality SLM contains frequencies from about 10 Hz to 20,000 Hz, but depending on the frequency weighting used, not all frequencies are treated the same. A selectable frequency weighting network, or filter, is then applied to the signal. These networks most commonly include the A-, B-, and C-weighting functions shown in the bottom panel of Figure 16.2. For OSHA noise monitoring measurements, the A-scale, which de-emphasizes the low frequencies and to a smaller extent the high frequencies, is used. In addition to the common A scale (which approximates the 40 phon level of hearing) and C scale (100 phon level), other scales, including dB(linear) may be included in the meter.

Next, (not shown) the signal is squared to reflect the fact that sound pressure level in decibels is a function of the square of the sound pressure. The signal is then applied to an exponential averaging network, which defines the meter's dynamic response characteristics. In effect, this response creates a moving-window, short-time average display of the sound waveform. The two most common settings are defined as FAST, which has a time constant of 0.125 second (s), and SLOW, which has a time constant of 1.0 s. These time constants were established decades ago to give analog needle indicators a rather sluggish response so that they could be read by the human eye even when highly fluctuating sound pressures were measured. Under the FAST or SLOW dynamics, the meter indicator rises exponentially toward the decibel value of an applied constant SPL. In theory, when driven by an exponential process, the indicator would reach the actual value at infinite time; however, the time constant defines the time period within which the indicator reaches 63% of the maximum value in response to a constant input. For OSHA measurements, the SLOW setting is used, and this setting is best when the average value or average as it is changing over time is desired. The FAST setting is more appropriate when the variability or range of fluctuations of a time-varying sound is desired. On certain SLMs, a third time constant, IMPULSE, may also be included for measurement of sounds which have sharp transient characteristics over time and are generally less than one second in duration, exemplified by gun shots or impact machinery such as drop forges and embossing processes. The IMPULSE setting has an exponential rise time constant of 35 ms and a decay time of 1.5 s. It is useful to afford the observer the time to view the maximum value of a burst of sound before it decays, and is more commonly applied in community and business machine noise measurements than in industrial settings.

Microphone Considerations

Most SLMs have interchangeable microphones which offer varying frequency response, sensitivity, and directivity characteristics (Peterson, 1979).¹⁸ The *response* of the microphone is the ratio of electrical output (in volts, V) to the sound pressure at the diaphragm of the microphone. Sound pressure is commonly expressed in Pascals (Pa) for free-field conditions (where there are no sound reflections resulting in reverberation), and the free-field voltage response of the microphone is given as mV/Pa. When specifications for *sensitivity* or *output level* are given, the response is based on a pure tone sound wave input. Typically, the output level is provided in dB re 1 V at the microphone electrical terminals and the reference sensitivity is 1 V/Pa.

Most microphones that are intended for industrial noise measurements are essentially *omnidirectional* (that is, nondirectional) in their response for frequencies below about 1,000 Hz. When the physical diameter of the microphone is comparable in length to the wavelength of the sound frequency (as occurs at higher frequencies), the microphone, even an omnidirectional one, will exhibit some directionality. This means that depending on the angle of the microphone's diaphragm in relation to the noise, the measurement readout can be less than or even greater than the true value. The 360-degree response pattern of a microphone is called its *polar response*, and the pattern is generally symmetrical about the axis perpendicular to the diaphragm. Some microphones are designed to be highly directional; one example is the cardioid design which has a heart-shaped polar response wherein the maximum sensitivity is for sounds whose direction of travel causes them to enter the microphone at 0 degrees (or the *perpendicular incidence response*), and minimum sensitivity is for sounds entering at 180 degrees behind the microphone. The response at 90 degrees, where sound waves travel and enter parallel to the diaphragm, is known as the *grazing incidence response*. Another response pattern, called the *random incidence response*, represents the mean response of the microphone for sound waves that strike the diaphragm from all angles with equal probability. This response characteristic is the most versatile, and thus it is the response pattern most often applied in the U.S. Hypothetical response characteristics for different sound wave incidences are shown in Figure 16.5.

Because most U.S. SLM microphones are omnidirectional and utilize the random-incidence response, it is best for an observer to point the microphone at the primary noise source and hold it at an angle of incidence of approximately 70 degrees. This will produce a measurement most closely corresponding to the random-incidence response. Care must be taken to avoid shielding the microphone with the body

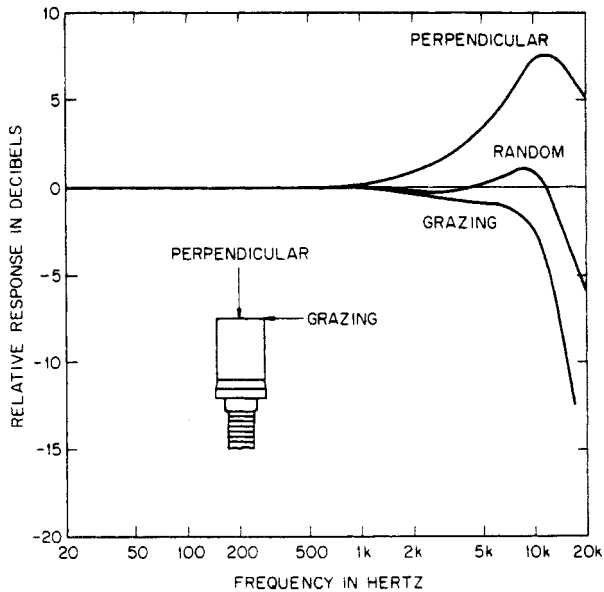

FIGURE 16.5 Frequency response of a hypothetical microphone for three angles of incidence. (Adapted from Peterson, A. P. G. [1979]. Noise measurements: Instruments, in C. M. Harris [Ed.] *Handbook of Noise Control* [pp. 5-1-5-19]. New York: McGraw-Hill. With permission.)

or other structures. The response of microphones can also vary with temperature, atmospheric pressure, and humidity, with temperature being the most critical factor. Correction factors for variations in decibel readout due to temperature effects are supplied by most microphone manufacturers. Atmospheric effects are generally only significant when measurements are made in aircraft or at very high altitudes, and humidity has a negligible effect except at very high levels. In any case, microphones must not be exposed to moisture or large magnetic fields, such as those produced by transformers. When used in windy conditions, a foam windscreen should be placed over the microphone. This will reduce the contaminating effects of wind noise, while only slightly influencing the frequency response of the microphone at primarily high frequencies. In an industrial setting, the windscreen offers the additional benefit of protection of the microphone from damage due to striking and/or airborne foreign matter.

Root Mean Square

Because sound consists of pressure fluctuations above and below ambient air pressure for which the arithmetic average is zero, a *root mean square* (rms) averaging procedure is applied within the SLM when FAST, SLOW, or IMPULSE measurements are taken. In effect, each pressure (or converted voltage) value is squared, the arithmetic sum of all squared values is then obtained, and finally the square root of the sum is computed to provide the rms value. The rms value is what appears on the meter's display.

True Peak SLM

Some SLMs include an unweighted *TRUE PEAK* setting which does not utilize the rms measurement averaging technique, but instead provides an indication of the actual peak SPL reached during a pressure impulse. This measurement mode is necessary for determining if the OSHA limit of 140 dB for impulsive exposure is exceeded. A Type 1 or 2 meter must be capable of measuring a 50- μ s pulse. It is important to note that the rms-based IMPULSE dynamics setting is unsuitable for measurement of TRUE PEAK SPLs.

Analog vs. Digital Readouts

In regard to the final component of an SLM shown in Figure 16.4, the indicator display or readout, much debate has existed over whether an analog (needle pointer or bar "thermometer-type" linear display) or

digital (numeric) display is best. Ergonomics research indicates that while the digital readout affords higher precision of information to be presented in a smaller space, its Achilles heel is that the digits (particularly the least significant position) become impossible to read when the sound level is fluctuating rapidly. Also, it is more difficult for the observer to capture the maximum and minimum values of a sound, as is often desirable using the FAST response, or the maximum impulse peak attained, with a digital readout. On the other hand, if very precise measurements down to a fraction of a dB are needed, the digital indicator is preferable as long as the meter incorporates an appropriate time integrating or averaging feature or “hold” setting so that the data values can be captured by the human eye. Because of the advantages and disadvantages of each type of display, some contemporary SLMs include both analog and digital readouts.

Sound Level Meter Applications

It is important to note that the standard SLM is intended to measure sound levels at a given moment in time, although certain specialized devices can perform integration or averaging of levels over an extended period of time to provide a long-term descriptor of the noise. When the nonintegrating/averaging SLM is used for noise exposure measurements in the workplace, it is necessary to sample and make multiple manual data entries on a record to characterize the exposure. This technique is usually best limited to area sampling, not individual employee measurements, because it is difficult for the observer to hold the microphone near the employee’s ear and to closely shadow the employee as he/she moves about the workplace. Furthermore, the sampling process becomes more difficult as the fluctuations in a noise become more rapid and/or random in nature.

Dosimeter

The “*audio-dosimeter*” or more simply, “*dosimeter*,” is a battery-powered, highly portable device which is derived directly from an SLM but also features the ability to obtain special measures of noise exposure (discussed later) which relate to regulatory compliance and hearing hazard risk. Dosimeters are very compact and are generally worn on the belt or in the pocket of an employee, with the microphone generally clipped to the lapel or shoulder of a shirt or blouse. The intent is to obtain a noise exposure log or record over the course of a full or partial workshift, and to obtain, at a minimum, a readout of the TWA exposure and noise dose for the period measured. Depending upon the features, the dosimeter can log the time history of exposure, providing a running histogram of noise levels on a short time interval (such as one-minute) basis, compute statistical distributions of the noise exposures for the period, flag and record exposures which exceed OSHA maxima of 115 dBA continuous or 140 dB TRUE PEAK, and compute average metrics using 3 dB, 5 dB, or even other time-versus-level exchange rates. The dosimeter eliminates the need for the observer to set up a discrete sampling scheme or follow the worker, both of which are necessary with a conventional SLM. However, it is important that the observer establish rapport and gain the confidence of the worker wearing the dosimeter, and convey at least the following information: (1) to behave normally as to the work activity, (2) to not tamper with the dosimeter or microphone, (3) to return the device when visiting restrooms or entering damp areas, (4) to return the device if there is a need to approach large transformers or other magnetic fields, and (5) to understand the purpose of the dosimetry. Since they are designed to be worn on the noise-exposed employee, dosimeters are typically thought of as devices for personal measurements, but they may also be tripod-mounted or held by an observer for area or survey measurements and are very useful for obtaining community noise measurements as well.

Spectrum Analyzer

The *spectrum analyzer* is an advanced SLM which incorporates selective frequency-filtering capabilities to provide an analysis of the noise level as a function of frequency. In other words, the noise is broken down into its frequency components and a distribution of the noise energy in all measured frequency bands is available. Bands are delineated by upper and lower edge or cutoff frequencies and a center frequency. Different widths and types of filters are available, with the most common width being the *octave filter*, wherein the center frequencies of the filters are related by multiples of two (that is, 31.5, 63,

125, 250, ..., 4,000, 8,000, and 16,000 Hz), and the most common type being the center frequency proportional, wherein the width of the filter depends on the center frequency (as in an octave filter set, in which the passband width equals the center frequency divided by $2^{1/2}$). The *octave band*, commonly called 1/1 octave filter, has a center frequency, cf, which is equal to the geometric mean of the upper (f_u) and lower (f_l) cutoff frequencies. The formulae to compute the center frequency for the octave filter, as well as the band edge frequencies, are:

$$\text{center frequency, cf} = (f_u * f_l)^{1/2} \quad \text{upper cutoff, } f_u = (\text{cf})2^{1/2} \quad \text{lower cutoff, } f_l = (\text{cf})/2^{1/2} \quad (7)$$

More precise spectral resolution can be obtained with other center frequency proportional filter sets with narrower bandwidths, the most common being the 1/3-octave, and with constant percentage bandwidth filter sets, such as 1 or 2% filters. Note that in both types, the filter bandwidth increases as the center frequency increases. Still other analyzers have constant bandwidth filters, such as 20 Hz-wide bandwidths which are of constant width regardless of center frequency. While in the past most spectrum analyzer filters have been analog devices with “skirts” or overshoots extending slightly beyond the cutoff frequencies, digital computer-based analyzers are now very common. These “computational” filters use fast Fourier transform (FFT) algorithms to compute sound level in a prespecified band of fixed resolution. FFT devices can be used to obtain very high resolutions of noise spectral characteristics using bandwidths as low as 1 Hz. However, in most industrial noise applications, a 1/1- or 1/3-octave analyzer will suffice unless the noise has considerable power in near-tonal components which must be isolated. One caution is in order: if a noise fluctuates in time and/or frequency, an integrating/averaging analyzer should be used to achieve good accuracy of measurements. It is important that the averaging period be long in comparison to the variability of the noise being sampled.

Inexpensive spectrum analyzers sometimes have filter sets which must be addressed individually in obtaining a measurement. Such devices are called *sequential analyzers* and the operator must manually (or via computer control) step through each filter separately and then read the result. Obviously, sequential filters are problematic when applied to the measurement of a fluctuating noise. On the other hand, *real-time analyzers* incorporate parallel banks of filters which can process all frequency bands simultaneously, and the signal output may be controlled by a SLOW, FAST, or other time constant setting, or it may be integrated or averaged over a fixed time period to provide L_{OSHA} , L_{eq} , or other average-type data.

While occupational noise is monitored with a dosimeter or SLM for the purpose of noise exposure compliance (using A-weighted broadband measurement), or assessment of hearing protection adequacy (using C-weighted broadband measurement), both of these applications can also be addressed (in some cases more accurately) with the use of spectral measurements of the noise level. For instance, the OSHA occupational noise exposure standard (OSHA, 1983)¹⁹ allows the use of octave band measurements reduced to broadband dBA values to determine if noise exposures exceed dBA limits defined in Table G-9 of the standard. Furthermore, Appendix B of the standard concerns hearing protector adequacy and allows the use of an octave band method for determining, on a spectral rather than a broadband basis, whether a hearing protector is adequate for a particular noise spectrum. It is also noteworthy that spectral analysis can help the hearing conservationist discriminate noises as to their hazard potential even though they may have similar A-weighted SPLs. This is illustrated in Figure 16.6, where both noises would be considered to be of equal hazard by the OSHA-required dBA measurements (since they both are 90 dBA), but the 1/3-octave analysis demonstrates that the lowermost noise is more hazardous as evidenced by the heavy concentration of energy in the midrange and high frequencies.

Perhaps the most important application of the spectrum analyzer is to obtain data that will provide the basis for engineering noise control solutions. For instance, in order to select an absorption material for lining interior surfaces of a workplace, the spectral content of the noise must be known so that the appropriate density and thickness of material may be identified. If the noise is found to be primarily of low frequency, the absorption techniques may not provide adequate reduction because low frequencies are more difficult to absorb than high frequencies.

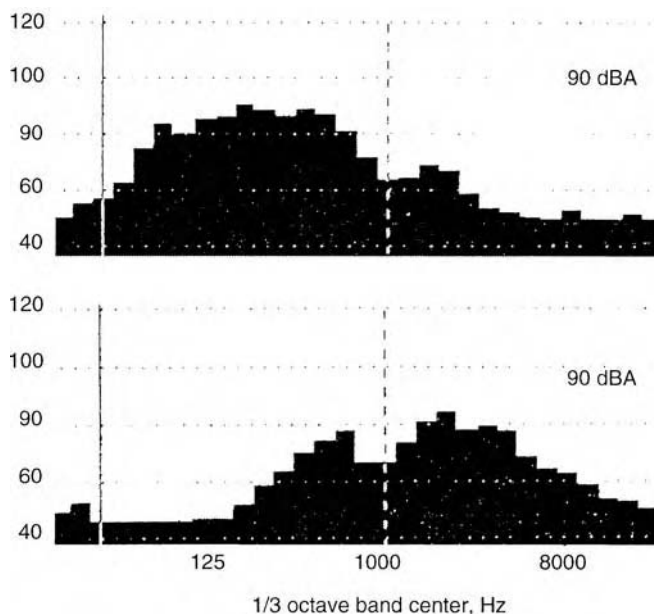

FIGURE 16.6 Spectral differences for two different noises which have the same dBA value.

Lacking a spectrum analyzer, the hearing conservationist can obtain a very rough indication of the dominant spectral content of a noise by using an SLM and taking measurements in both dBA and dBC for the same noise. If the $(\text{dBC} - \text{dBA})$ value is large, that is, about 5 dB or more, then it can be concluded that the noise has considerable low frequency content. If, on the other hand, the $(\text{dBC} - \text{dBA})$ value is negative, then the noise clearly has strong midrange components, since the A-weighting curve exhibits slight amplification in the 2,000 to 4,000 Hz range. Such rules-of-thumb rely on the differences in the C- and A-weighting curves shown in Figure 16.2. However, they should not be relied upon in lieu of a spectrum analysis if the noise is believed to have high frequency or narrow band components that need noise control attention.

Acoustical Calibrator and Microphone Calibration

Each of the instruments described above contains a microphone which transduces the changes in pressure and inputs this signal into the electronics. While modern sound measurement equipment is generally stable and reliable, calibration is necessary to match the microphone to the instrument so that the accuracy of the measurement is assured. Because of its susceptibility to varying environmental conditions and damage due to rough handling, moisture, and magnetic fields, the microphone is the weakest link in the measurement equipment chain. Therefore, an acoustical calibrator should be applied before and after each measurement with an SLM. The pre-test calibration ensures that the instrument is indicating the correct SPL for a standard reference calibrator output at a specified SPL and frequency (most often 94 dB at 1,000 Hz). The post-test calibration is done to determine if the instrumentation, including the microphone, has drifted during the measurement and if so, if the drift is large enough to invalidate the data obtained. Calibrators may be electronic transducer-type devices with loudspeaker outputs from an internal oscillator, or “pistonphones” which use a reciprocating piston in a closed cavity to produce sinusoidal pressure variations as the cylinder volume changes. Both types include adapters which allow the device to be mated to microphones of different diameters. Calibrators should be sent to the factory for annual calibration. SLMs and dosimeters used for occupational noise measurements should also be factory-calibrated on an annual basis.

There are many other issues which bear on the proper application of sound level measurement equipment, such as microphone selection and placement, averaging time and sampling schemes, and

statistical data reduction techniques, all of which are beyond the scope of this chapter. Further coverage of measurement and instrumentation appears in Harris (1991).²⁰

Measures for Quantifying Occupational Noise Levels

Exchange Rates

As alluded to earlier in the discussion on the OSHA occupational noise exposure standard, most noise regulations stipulate that a worker's exposure may not exceed a maximum daily accumulation of noise energy, and that the total energy is defined by the combination of exposure duration and intensity of the noise. In other words, in OSHA terms the product of duration and intensity must remain under the regulatory cap or *permissible exposure limit* (PEL) of 90 dBA time-weighted average (TWA) for an 8-hour work period, which is equivalent to a 100% noise dose. Because both noise amplitude and noise duration determine the energy in the exposure, average-type measures of exposure are based on simple algorithms or "exchange rates" which trade amplitude for time and vice versa. Much debate has occurred over the past several decades as to which exchange rate is most appropriate for prediction of hearing damage risk, and most countries currently use either a 3- or 5-dB relationship. The OSHA exchange rate is 5 dB, which means that an increase (decrease) in decibel exposure by 5 dB is equivalent to a doubling (halving) of exposure time. For instance, using the OSHA PEL of 90 dBA for 8 hours, if a noise is at 95 dBA, the allowable exposure per workday is half of 8 hours, or 4 hours. If a noise is at 85 dBA, the allowable exposure time is twice 8 hours, or 16 hours. These allowable reference exposure durations (T values) are provided in Table A-1 of the OSHA (1983)¹⁹ regulation, or they may be computed using the formula for T which appears below as Equation 14. The 5-dB exchange rate is predicated on the theory that intermittent noise is less damaging than continuous noise because some recovery from temporary hearing loss occurs during quiet periods. Arguments against it include the fact that an exchange of 5 dB for a factor of two in time duration has no real physical basis in terms of energy equivalence. Furthermore, there is some evidence that the quiet periods of intermittent noise exposures are insufficient in length to allow for recovery to occur. The 5-dB exchange rate is used for all measures associated with OSHA regulations, including the most general average measure of L_{OSHA} , the TWA referenced to an 8-hour duration, and noise dose in percent.

Most European countries use a 3-dB exchange rate, also known as the "equal energy rule." In this instance, a doubling (halving) of sound intensity, which corresponds to a 3 dB increase (decrease), equates to a doubling (halving) of exposure duration. The equal energy concept stems from the fact that if noise energy is doubled or halved, the equivalent decibel change is 3 dB. An exposure to 90 dBA for 8 hours using a 3 dB exchange rate is equivalent to a 120 dBA exposure of only 0.48 minute. Because each increase in decibels by 10 corresponds to a tenfold increase in intensity, the 30 dB increase from 90 to 120 dBA represents a 1,000-fold (10^3) increase in sound intensity, from 0.001 to 1 W/m². The 90 dBA exposure period is 8 hours or 480 minutes, and this must be reduced by the same factor as the SPL increase, so 480/1,000 equals 0.48 minute or 29 seconds. The 3-dB exchange rate is used for all measures associated with the equivalent continuous sound level, or L_{eq} .

Average and Integrated SPLs

As discussed earlier, conventional SLMs provide "momentary" dB measurements that are based on very short moving-window exponential averages using FAST, SLOW, or IMPULSE time constants. However, since the majority of noises fluctuate over time, one of several types of average measurements, discussed below, is usually most appropriate as a descriptor of the central tendency of the noise. Averages may be obtained in one of two ways: (1) by observing and recording conventional SLM readouts using a short time interval sampling scheme, and then manually computing the average value from the discrete values, or (2) by using an SLM or dosimeter which automatically calculates a running average value using microprocessor circuitry which provides either a true continuous integration of the area under the sound pressure curve or which obtains discrete samples of the sound at a very fast rate and computes the average. Generally, average measures obtained by method 2 yield more representative values because they are

based on continuous or near-continuous sampling of the waveform, which the human observer cannot perform. For sounds which are constant or slowly fluctuating in level, either method should provide representative values, although method 1 necessitates continuous vigilance by an observer.

The average metrics discussed below are generally considered as the most useful for evaluating noise hazards and annoyance potential. In most cases for industrial hearing conservation as well as community noise annoyance purposes, the metrics utilize the A-weighting scale. The equations are all in a form where the data values are considered to be discrete sound levels. Thus, they can be applied to data from conventional SLMs or dosimeters. For continuous sound levels (or when the equations are used to describe true integrating meter functioning), the Σ sign in the equations would be replaced by the integral

sign, \int_0^T and the t_i replaced by dt .

Variables used in the equations are as follows:

- L_i = dB level in measurement interval i N = number of intervals
- t_i = length of measurement interval i T = total measurement time period
- Q = exchange rate in dB t_i = time period of interval i

$$q = Q/\log_{10}(2) \begin{cases} \text{for 3 dB exchange, } q = 10.0 \\ \text{for 4 dB exchange, } q = 13.3 \\ \text{for 5 dB exchange, } q = 16.6 \end{cases}$$

The general form equation for *average SPL*, or $L_{average}$, L_{av} is:

$$L_{av}(Q) = q \log_{10} \left[\frac{1}{T} \sum_{i=1}^N \left(10^{\left(\frac{L_i}{q}\right)} * t_i \right) \right] \tag{8}$$

The *equivalent continuous sound level*, or, L_{eq} , equals the continuous sound level which, when integrated or averaged over a specific time, would result in the same energy as a variable sound level over the same time period. The equation for L_{eq} , which uses a 3-dB exchange rate, is:

$$L_{eq} = L_{av}(3) = 10 \log_{10} \left[\frac{1}{T} \sum_{i=1}^N \left(10^{\left(\frac{L_i}{10}\right)} * t_i \right) \right] \tag{9}$$

In applying the L_{eq} , usually the individual L_i values are in dBA. Equation 9 may also be used to compute the overall equivalent continuous sound level (for a single site or worker) from individual L_{eq} 's that are obtained over contiguous time intervals by substituting the L_{eq} values in the L_i variable. L_{eq} values are often expressed with the time period over which the average is obtained; for instance, L_{eq} (24) is an equivalent continuous level measured over a 24-hour period. Another average measure which is derived from the L_{eq} and often used for community noise quantification is the L_{dn} . The L_{dn} is simply a 24-hour L_{eq} measurement with a 10-dB penalty added to all nighttime noise levels from 10 P.M. to 7 A.M. The rationale for the penalty is that humans are more disturbed by noise, especially due to sleep arousal, during nighttime periods.

The equation for the *OSHA average noise level*, or L_{OSHA} , which uses a 5-dB exchange rate is:

$$L_{OSHA} = L_{av}(5) = 16.61 \log_{10} \left[\frac{1}{T} \sum_{i=1}^N \left(10^{\left(\frac{L_{iA}}{16.61}\right)} * t_i \right) \right] \tag{10}$$

where L_{iA} is in dBA, slow response.

OSHA's *time-weighted average* (TWA) is a special case of L_{OSHA} which requires that the total time period always be 8 hours, that time is expressed in hours, and that sound levels below 80 dBA, termed the *threshold level*, are not included in the measurement:

$$TWA = 16.61 \log_{10} \left[\frac{1}{8} \sum_{i=1}^N \left(10^{\left(\frac{L_{iA}}{16.61} \right)} * t_i \right) \right] \quad (11)$$

where L_{iA} is in dBA, slow response; T is always 8 hours; only $L_{iA} \geq 80$ dBA are included.

OSHA's *noise dose* is a percentage representation of the noise exposure, where 100% is the maximum allowable dose, corresponding to a 90 dBA TWA referenced to 8 hours. Dose utilizes a *criterion sound level*, which is presently 90 dBA, and a *criterion exposure period*, which is presently 8 hours. A noise dose of 50% corresponds to a TWA of 85 dBA, and this is known as the OSHA *action level*. Calculation of dose, D, is as follows:

$$D = \frac{100}{T_c} \sum_{i=1}^N \left(10^{\left(\frac{L_{iA} - L_c}{q} \right)} * t_i \right) \quad (12)$$

where L_{iA} is in dBA, slow response; L_c is the criterion sound level; q is the criterion exposure duration; only $L_{iA} \geq 80$ dBA are included.

Noise dose, D, can also be expressed as follows, for a constant sound level over the workday:

$$D = 100 * \left(\frac{C_1}{T_1} + \frac{C_2}{T_2} + \dots + \frac{C_n}{T_n} \right) \quad (13)$$

where C_i is the total time (hours) of actual exposure at L_i ; T_i is total time (hours) of reference allowed exposure at L_i , from Table G-16a of OSHA, 1983;¹⁹ $\frac{C_i}{T_i}$ represents a partial dose at sound level i.

T, the *reference allowable* exposure for a given sound level, can also, in lieu of consulting Table G-16a in OSHA (1983),¹⁹ be computed as:

$$T = \frac{8}{2^{(L-90)/5}} \quad (14)$$

where L is the measured dBA level.

Two other useful equations to compute dose, D, from TWA and vice versa are:

$$D = 100 * 10^{\left(\frac{TWA-90}{16.61} \right)} \quad (15)$$

$$TWA = \left[16.61 \log_{10} \left(\frac{D}{100} \right) \right] + 90 \quad (16)$$

TWA can also be found for each value of dose, D, in Table A-1 of OSHA (1983).¹⁹

A final measure that is particularly useful for quantifying the exposure due to single or multiple occurrences of an acoustical event (such as a complete operating cycle of a machine, a vehicle drive-by, or aircraft flyover), is the *sound exposure level*, or SEL. It has also been suggested for use in exposure regulations for industry, but to date has not been incorporated into OSHA requirements. The SEL

represents a sound of one second length that imparts the same acoustical energy as a varying or constant sound that is integrated over a specified time interval, t_i , in seconds. Over t_i , an L_{eq} is obtained, which indicates that SEL is used only with a 3-dB exchange rate. A reference duration of one second is applied for t_0 in the following equation for SEL:

$$SEL = L_{eq} + 10 \log_{10} \left(\frac{t_i}{t_0} \right) \quad (17)$$

where L_{eq} is the equivalent sound pressure level measured over time period t_i .

Example Computational Problems

Because the majority of industrial noise exposure problems in the U.S. involve measurements to determine OSHA compliance and hearing conservation program needs, the most common measurements from those discussed above entail calculation of the OSHA dose and TWA. Therefore, example computational problems using these measures follow.

Example 1. Workshift less than 8-hours, reading from SLM

Exposures comprising a 7-hour workday consist of 1 hour at 95 dBA, 2 hours at 90 dBA, and 4 hours at 85 dBA, with measurements taken from an SLM. What is the dose and TWA?

Use Equation 14 (or OSHA, 1983,¹⁹ Table G-16a) to determine that 95 dBA is allowed for 4 hours, 90 dBA for 8 hours, and 85 dBA for 16 hours. Then use Equation 13 to determine the partial doses associated with each exposure and the total dose for the workday:

$$D = 100 * \left(\frac{1}{4} + \frac{2}{8} + \frac{4}{16} \right) = 75\%$$

Since 50% action level is exceeded, a hearing conservation program (HCP) is needed.

Equation 16 (or OSHA, 1983,¹⁹ Table A-1) is then used to compute the TWA:

$$TWA = \left[16.61 \log_{10} \left(\frac{75}{100} \right) \right] + 90 = 87.9 \text{ dBA per 8-hour day}$$

Note: As shown in this example, regardless of the total workday, the OSHA method references everything to an 8-hour criterion, with PEL of 90 dBA TWA. This problem could also have been solved by application of Equations 11 and 12.

Example 2. Workshift greater than 8-hours, reading directly from dosimeter

A dosimeter is set up to run for a 12-hour shift, and the readout at the end of the period is $D = 300\%$. If the dosimeter is programmed for an 8-hour criterion exposure duration, a 90 dBA criterion sound level, an 80 dBA threshold sound level, and a 5-dB exchange rate, then the OSHA dose may be read directly from the meter regardless of the fact that the total measurement period is 12 hours. The TWA can then be computed using Equation 16 (or OSHA, 1983,¹⁹ Table A-1):

$$TWA = \left[16.61 \log_{10} \left(\frac{300}{100} \right) \right] + 90 = 97.9 \text{ dBA}$$

Example 3. Workshift greater than 8 hours, reading from SLM

A sound level meter is used to measure exposures in a 12-hour workshift and the average levels obtained over the four time periods sampled are 3 hours at 92 dBA, 2 hours at 98 dBA, 6 hours at 96 dBA, and 1 hour meal time at 75 dBA.

First, the 75 dBA period is deleted in the TWA computation (but not in I_{OSHA} if it is to be calculated) since it is less than the OSHA 80 dBA threshold. Then, Equation 11 is used to compute the TWA, which is based on an 8-hour criterion (therefore, $T = 8$):

$$\begin{aligned} \text{TWA} &= 16.61 \log_{10} \left[\frac{1}{8} \left(3 * 10^{92/16.61} + 2 * 10^{98/16.61} + 6 * 10^{96/16.61} \right) \right] \\ &= 16.61 \log_{10} \left[\frac{1}{8} (1037416.8 + 1588876.7 + 3612451.8) \right] \\ &= 16.61 \log_{10} 779843.2 \\ &= 97.9 \text{ dBA} \end{aligned}$$

Next, Equation 15 is used to compute the dose from the TWA:

$$\begin{aligned} D &= 100 * 10^{\left(\frac{97.9-90}{16.61} \right)} \\ D &= 299\% \end{aligned}$$

Example 4. Workshift greater than 8 hours, dosimeter measurement for only partial workshift

A dosimeter is worn by an employee for 7 hours of a 12-hour workshift. It was not possible to apply the dosimeter for the full shift, but it has been determined, based on discussion with employees and direct observation, that the entire workshift is consistent in regard to work activity. The dose measured for the 7-hour period is 115%. Note that this dose is based on only 7 hours of data and that the OSHA criterion exposure period of 8 hours is reflected in the dose calculation from the meter. Since only 7 hours of data are included, the dose is lower than that which would occur during a full 12-hour shift.

Because the entire workshift is consistent with respect to noise-producing work activity, it is reasonable to assume that the same rate of dose per hour would continue through the complete shift.

The 7-hour sampling period included: (1) one 15-minute rest break, and (2) one 30-minute meal break. The remaining 5-hour period that was not sampled does include one 15-minute break.

7 hours sampled, less the total of meal/breaks of 45 minutes = 375 minutes in noise

Total 12-hour shift = (12 * 60) – 60 minutes of meal/breaks = 660 minutes in noise

The 12-hour shift dose can be computed via either of the following methods:

1. Set up a proportional relationship as follows:

$$\frac{115\% \text{ dose}}{375 \text{ minutes}} = \frac{D\% \text{ dose}}{660 \text{ minutes}}$$

$$375D = 75900$$

$$D = 202.4\%$$

Applying Equation 16 (or OSHA, 1983,¹⁹ Table A-1):

$$\text{TWA} = 95.1 \text{ dBA}$$

2. Calculate a rate of dose per minute:

$$\frac{115\% \text{ dose}}{375 \text{ minutes}} = 0.3067\% \text{ dose per minute}$$

$$D = 660 \text{ minutes} * 0.3067\% \text{ dose/minute} = 202.4\%$$

Applying equation 16 (or OSHA, 1983,¹⁹ Table A-1):

$$\text{TWA} = 95.1 \text{ dBA}$$

16.5 Industrial Noise Regulation and Abatement

Indicators of the Need for Attention to Noise

The need for management, or perhaps more appropriately, abatement of industrial noise is indicated when: (1) noise creates sufficient intrusion and operator distraction such that job performance (and even job satisfaction) are compromised; (2) noise creates interference with important communications and signals, such as inter-operator communications, machine- or process-related aural cues, and/or alerting/emergency signals; and (3) noise exposures constitute a hazard for noise-induced hearing loss in workers. While this chapter primarily targets problem 3, which is governed by OSHA federal regulations in general industry (OSHA, 1983)¹⁹ and MSHA (Mine and Safety Health Administration) regulations in mining, the principles of noise measurement, management, and abatement discussed herein may also be applied in mitigating problems 1 and 2.

OSHA Noise Exposure Limits

In regard to combating the hearing loss problem, in OSHA terms if the noise dose exceeds the OSHA action level of 50%, which corresponds to an 85 dBA TWA, the employer must institute a hearing conservation program (HCP) which consists of several facets, to be discussed later (OSHA, 1983).¹⁹ (It is noteworthy that the OSHA regulation specifically exempts employers in oil and gas well drilling and servicing from the HCP requirements, although they are subject to the 100% dose criterion.) If the criterion level of 100% dose is exceeded (which corresponds to the Permissible Exposure Level of 90 dBA TWA for an 8-hour day), the regulations specifically state that steps must be taken to reduce the employee's exposure to the PEL or below via administrative work scheduling and/or the use of engineering controls. It is specifically stated that hearing protection devices (HPDs) shall be provided if administrative and/or engineering controls fail to reduce the noise to the PEL. Therefore, in applying the letter of the law, HPDs are only intended to be relied upon when administrative or engineering controls are infeasible or ineffective. The final OSHA noise level requirement pertains to impulsive or impact noise, which is not to exceed a TRUE PEAK SPL limit of 140 dB.

Hearing Conservation Programs and the Systems Approach

Shared Responsibility among Management, Workers, and Government

A successful HCP, which includes many facets relating to the measurement, management, and control of noise, depends upon the shared commitment of management and labor, as well as the quality of services and products provided by external noise control consultants, audiology or medical personnel who conduct the hearing measurement program, and vendors (for example, hearing protection suppliers). Furthermore, government regulatory agencies, such as OSHA and MSHA, have a responsibility to maintain and disseminate up-to-date noise exposure regulations and HCP guidance, to conduct regular in-plant monitoring of noise exposure and quality of HCPs, and to provide strict enforcement where inadequate noise control and hearing protection exists. And finally, the "end-user" of the HCP, that is, the worker him/herself, must be an informed and motivated participant. For instance, if a fundamental component of the HCP is the personal use of hearing protection devices (HPDs), the effectiveness of the program in preventing NIHL will depend most heavily on the worker's commitment to properly and consistently wear the HPD. Failure by any of these groups to carry out their responsibilities can result in HCP failure and worker hearing loss.

Hearing Conservation Program Structure and Components

Hearing conservation in industry should be thought of as a strategic, programmatic effort that is initiated, organized, implemented, and maintained by the employer, with cooperation from other parties as indicated above. A well-accepted approach is to address the noise exposure problem from a *systems* perspective, wherein empirical noise measurements provide data input which drives the implementation

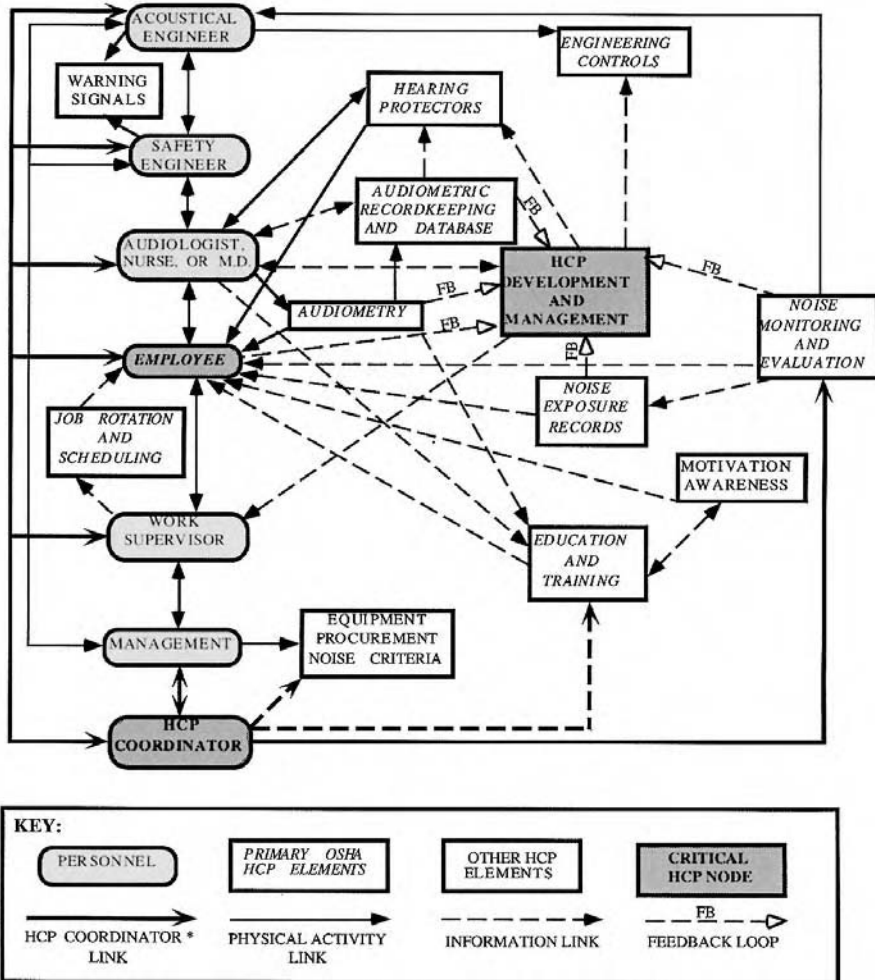

* The HCP Coordinator is often involved directly with the design and/or selection of noise countermeasures.

Note: All elements of the HCP program may act as throughput nodes, in that incoming information may travel through the intermediate node and out to another adjacent node (node-to-node links are not necessary, as long as the nodes are joined through an intermediate node).

FIGURE 16.7 System and components of an industrial hearing conservation program.

of countermeasures against the noise (including engineering controls, administrative strategies, and personal hearing protection). Subsequently, noise and audiometric data, which reflect the effectiveness of those countermeasures, serve as feedback for program adjustments and improvements. Figure 16.7 illustrates the human and other system components that are typically included in an HCP, along with the links between components. Not all programs will include all of these components; for instance, personal hearing protection may be unnecessary if engineering controls provide sufficient noise reduction. A brief discussion of the major elements of an HCP, as dictated by OSHA (1983),¹⁹ follows.

Monitoring

Noise exposure monitoring is intended to identify employees for inclusion in the HCP and to provide data for the selection of HPDs. The data are also useful for identifying areas where engineering noise control solutions and/or administrative work scheduling may be necessary. All OSHA-related measurements, with the exception of the TRUE PEAK SPL limit, are to be made using an SLM or dosimeter set on the dBA scale, SLOW response, using a 5-dB exchange rate, and incorporating all sounds whose levels

are from 80 to 130 dBA. It is unspecified, but must be assumed that sounds above 130 dBA should also be monitored. (Of course, such noise levels represent OSHA noncompliance since the maximum allowable continuous sound level is 115 dBA.) The measurement instrument should be ANSI Type 2¹⁷ or better and calibrated to a known standard level before and after noise measurement. Monitoring strategies must take into account the effects of worker movement and noise level variation over time. Although no specific time interval between consecutive monitoring samples is specified, new samples should be taken whenever alterations in equipment or production produce changes in noise exposure. Appendix G of the OSHA regulation suggests that monitoring be conducted at least once every one or two years.

Relating to the noise monitoring requirement is that of notification. Employees must be given the opportunity to observe the noise monitoring process, and they must be notified when their exposures exceed the 50% dose (85 dBA TWA) level.

Audiometric Testing Program

All employees whose noise exposures are at the 50% dose level or above must be included in a pure-tone audiometric testing program wherein a baseline audiogram is completed within six months of the first exposure, and subsequent tests are done on an annual basis. Prior to the baseline audiogram, the worker must avoid workplace noise exposure for 14 hours, or alternatively, use HPDs. Annual audiograms are compared against the baseline to determine if the worker has experienced a *standard threshold shift* (STS), which is defined as an increase in hearing threshold level relative to the baseline of an average of 10 dB at 2,000, 3,000, and 4,000 Hz in either ear. The annual audiogram may be adjusted for age-induced hearing loss (presbycusis) using gender-specific correction data found in Appendix F of the regulation. All OSHA-related audiograms must include 500, 1,000, 2,000, 3,000, 4,000, and 6,000 Hz, in comparison to most clinical audiograms which extend from 125 to 8,000 Hz. If an STS is revealed, a licensed physician or audiologist must review the audiogram and determine the need for further audiological or otological evaluation, the employee must be notified of the STS, and the selection and proper use of HPDs must be revisited. An annual audiogram is substituted for the original baseline when the STS is determined to be persistent or when the annual audiogram indicates significant improvement over the baseline.

Hearing Protection Devices

A selection of HPDs that are suitable for the noise and work situation must be made available to all employees whose TWA exposures meet or exceed 85 dBA. *Earplugs* consist of vinyl, silicone, spun fiberglass, cotton/wax combinations, and closed-cell foam products that are inserted into the ear canal to form a noise-blocking seal. Proper fit to the user's ears and training in insertion procedures are critical to the success of earplugs. A related device is the *semi-insert* or *ear canal cap* which consists of earplug-like pods that are positioned at the rim of the ear canal and held in place by a lightweight headband. The headband is useful for storing the device around the neck when the user moves out of the noise. *Earmuffs* consist of earcups, usually of a rigid plastic material with an absorptive liner, that completely enclose the outer ear and seal around it with foam- or fluid-filled cushions. A headband connects the earcups, and on some models this band is adjustable so that it can be worn over-the-head, behind-the-neck, or under-the-chin, depending upon the presence of other headgear, such as a welder's mask. In general terms, as a group, earplugs provide better attenuation than earmuffs below about 500 Hz and equivalent or greater protection above 2,000 Hz. At intermediate frequencies, earmuffs typically have the advantage in attenuation. Earmuffs are generally more easily fit by the user than earplugs or canal caps, and depending on the temperature and humidity of the environment, the earmuff can be uncomfortable (in hot or high-humidity environments) or a welcome ear insulator (in a cold environment). Semi-inserts generally offer less attenuation and comfort than earplugs or earmuffs, but because they are readily storable around the neck, they are convenient for those workers who frequently move in and out of noise. A thorough review of HPDs and their application may be found in Berger and Casali (1997).²¹ Recent new technologies in hearing protection have emerged, including electronic devices offering active noise cancellation, communications capabilities, and noise-level-dependent attenuation, as well as passive, mechanical HPDs which offer level-dependent attenuation and near flat or uniform attenuation spectra; these devices are reviewed in Casali and Berger (1996).²²

Regardless of its general type, HPD effectiveness depends heavily on the proper fitting and use of the devices (Park and Casali, 1991).²³ Therefore, the employer is required to provide training in the fitting, care, and use of HPDs to all affected employees (OSHA, 1983).¹⁹ Hearing protector use becomes mandatory when the worker has not undergone the baseline audiogram, has experienced an STS, or has a TWA exposure which meets or exceeds 90 dBA. In the case of the worker with an STS, the HPD must attenuate the noise to 85 dBA TWA or below. Otherwise, the HPD must reduce the noise to at least 90 dBA TWA.

The protective effectiveness or adequacy of an HPD for a given noise exposure must be determined by applying the attenuation data required by the EPA (1979)²⁴ to be included on protector packaging. These data are obtained from psychophysical threshold tests at nine 1/3 octave bands with centers from 125 to 8,000 Hz that are performed on human subjects, and the difference between the thresholds with and without the HPD on constitutes the attenuation at a given frequency. Spectral attenuation statistics (means and standard deviations) and the single number noise reduction rating (NRR), which is computed therefrom, are provided. The ratings are the primary means by which end-users compare different HPDs on a common basis and make determinations of whether adequate protection and OSHA compliance will be attained for a given noise environment.

The most accurate method of determining HPD adequacy is to use octave band measurements of the noise and the spectral mean and standard deviation attenuation data to determine the *protected exposure level* under the HPD. This is called the *NIOSH long method* or the *octave band* method. Computational procedures appear in NIOSH (1975).²⁵ Because this method requires octave band measurements of the noise, preferably with each noise band's data in TWA form, the data collection requirements are large and the method is not widely applied in industry. However, because the noise spectrum is compared against the attenuation spectrum of the HPD, a "matching" of exposure to protector can be obtained; therefore, the method is considered to be the most accurate available.

The NRR represents a means of collapsing the spectral attenuation data into one broadband attenuation estimate that can easily be applied against broadband dBC or dBA TWA noise exposure measurements. In the calculation of the NRR, the mean attenuation is reduced by two standard deviations; this translates into an estimate of protection theoretically achievable by 98% of the population (EPA, 1979).²⁴ The NRR is primarily intended to be subtracted from the dBC exposure TWA to estimate the protected exposure level in dBA, as via the following equation:

$$\text{Workplace TWA in dBC} - \text{NRR} = \text{Protected TWA in dBA} \quad (18)$$

Unfortunately, because OSHA regulations require that noise exposure monitoring be performed in dBA, the dBC values may not be readily available to the hearing conservationist. In the case where the TWA values are in dBA, the NRR can still be applied, albeit with some loss of accuracy. With dBA data, a 7 dB "safety" correction is applied to the NRR to account for the largest typical differences between C- and A-weighted measurements of industrial noise, and the equation is as follows:

$$\text{Workplace TWA in dBA} - (\text{NRR} - 7) = \text{Protected TWA in dBA} \quad (19)$$

While the above methods are promulgated by OSHA (1983)¹⁹ for determining HPD adequacy for a given noise situation, a word of caution is needed. The data appearing on HPD packaging are obtained under optimal laboratory conditions with properly fitted protectors and trained human subjects. In no way do the "experimenter-fit" protocol and other aspects of the current test procedure (ANSI S3.19-1974)²⁶ represent the conditions under which HPDs are selected, fit, and used in the workplace (Park and Casali, 1991).²³ Therefore, the attenuation data used in the octave band or NRR formulae shown above are highly inflated and cannot be assumed as representative of the protection that will be achieved in the field. The results of a review of research studies in which manufacturers' on-package NRRs were compared against NRRs computed from actual subjects taken with their HPDs from field

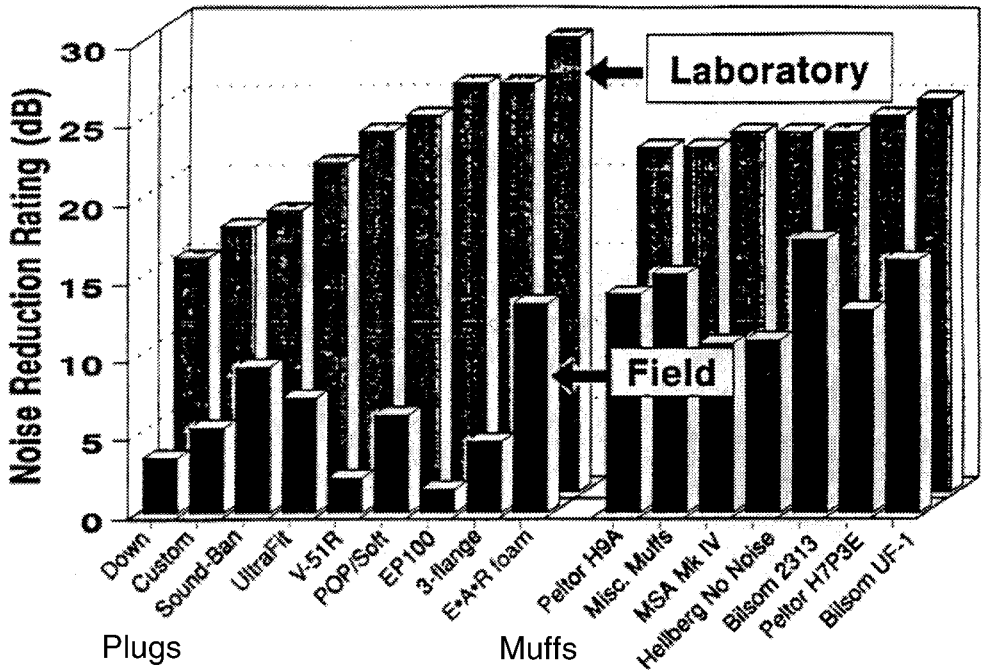

FIGURE 16.8 Comparison of hearing protection device NRRs by device type: manufacturers' laboratory data vs. real-world "field" data. (Adapted from Berger, E. H., Franks, J. R., and Lindgren, F. [1996]. International review of field studies of hearing protector attenuation, in A. Axelsson, H. Borchgrevink, R. P. Hamernik, P. Hellstrom, D. Henderson, and R. J. Salvi [Eds.], *Scientific Basis of Noise-Induced Hearing Loss*. [pp. 361-377], New York: Thieme Medical Publishers, Inc. With permission.)

settings is shown in Figure 16.8 (Berger, Franks, and Lindgren, 1996).²⁷ Clearly, the differences between laboratory and field estimates of HPD attenuation are large, and the hearing conservationist must take this into account when selecting protectors. Recent efforts by ANSI Working Group S12/WG11 have focused on the development of a testing standard which utilizes subject (not experimenter) fitting of the HPD and relatively naive (not trained) subjects to yield attenuation data that are more representative of those achievable under workplace conditions wherein an HCP is operated (described in Royster et al., 1996).²⁸ However, when this chapter was written, this draft standard had not been adopted into law promulgating its use in producing the data to be utilized in labeling HPD performance.

If the currently available HPD attenuation data are inaccurate, what steps should be taken to gain a more accurate estimate of the NRR for use in determining protected exposure levels? The OSHA (1989)²⁹ Field Operations Manual of the Office of General Industry Compliance Assistance indicates: "Citations for violations of 29CFR 1910.95(b)(1) shall be issued when engineering and/or administrative controls are feasible, both technically and economically; and (1) Employee exposure levels are so high that hearing protectors alone may not reliably reduce noise levels received by the employee's ear to the levels specified in Tables G-16 or G-16a of the Standard. Given the present state of the art, hearing protectors which offer the greatest attenuation may not reliably be used when employees' exposure levels border on 100 dBA." This guideline alludes to the importance of engineering controls as a primary countermeasure against high noise levels. The OSHA (1990)³⁰ Technical Manual of the Directorate of Technical Support states: "OSHA experience and the published scientific literature indicate that laboratory-obtained real-ear attenuation data for hearing protectors are seldom achieved in the workplace." ... Under "Field Attenuation of Hearing Protection": "When analyzing the attenuation a personal hearing protector may afford a noise-exposed employee in an actual work environment, the hearing protector shall be evaluated as follows: ... (2) To adjust for the lack of attainment of the laboratory-based noise reduction calculated

according to Appendix B (laboratory ratings) estimating techniques, apply a safety factor of 50%; that is, divide the calculated laboratory-based attenuation by two. (3) For dual protection (i.e., earplugs and muffs) add 5 dB to the NRR of the higher-rated protector.” For case 2, the derating factor may appear to be a reasonable strategy; however, these authors and others have argued that a constant derating factor is not appropriate because certain protectors (for example, earmuffs) are easier to fit properly than others (for example, user-formed earplugs), and thus the differences between laboratory and actual in-workplace performance will not be the same for all devices. In perusing Figure 16.8, this becomes quite apparent in that the laboratory NRRs for earplugs overestimate the field NRRs by an average of about 75%, while the laboratory NRRs for earmuffs overestimate the field NRRs by an average of only about 40%. These data would argue for the use of derating factors that differ by device type, not a constant derating such as the 50% OSHA recommendation. But in any case, the use of derating factors or other modifications of the NRR to adjust it for field applications is tenuous at best and should not be expected of the end user. The best solution is to establish a testing standard (and attenuation rating therefrom) which accurately predicts workplace protection achieved by HPDs, and this is the ANSI standard work described in Royster et al. (1996).²⁸

Training Program and Access to Information and Materials

An oft-overlooked, but essential component of an industrial HCP is an annual training program for all workers included in the HCP. The required training elements to be covered are: (1) the effects of noise on hearing; (2) purpose, selection, and use of HPDs; and (3) purpose and procedures of audiometric testing. It is essential to the success of an HCP that workers become acutely aware of the need for hearing conservation, understand and believe in the merits of the program, and develop a commitment to and the motivation for protecting their hearing. Employers must make the OSHA regulations available to affected employees and, upon request, make all training materials available to OSHA representatives.

Recordkeeping and Intra-Program Feedback

Accurate records must be kept of all noise exposure measurements, at least from the last two years, and audiometric test results for the duration of the worker’s employment. It is important, but not required by OSHA, that noise and audiometric data be used as feedback for improving the program as shown in the feedback loops of Figure 16.7. Because the primary goal of the HCP is to prevent NIHL for employees, the program’s effectiveness can be evaluated via *audiometric database analysis* (ADBA) for employees as a group, as opposed to individuals. By using population statistics from and inferential analysis of the database for exposed employees, problems can be identified early and corrective actions taken before significant threshold shifts appear in a number of individuals (Royster and Royster, 1986).³¹ ADBA, however, is not a substitute for annual individual audiogram review and comparison against baseline. As discussed previously, this type of intra-worker analysis is essential for identifying threshold shifts and implementing preventative measures that are specific to the individual worker and job environment. Also, discussion of individual audiogram data with employees can aid in motivating them to exercise care in their daily hearing conservation practices, and audiometric feedback, sometimes posted anonymously by code number but including each individual’s HPD use information, has been experimentally demonstrated to be an effective means of establishing higher HPD usage rates (Zohar, Cohen, and Azar, 1980).³²

Noise exposure records may be used as feedback to identify machines that need maintenance attention, to assist in the relocation of noisy equipment during plant layout efforts, to provide information for future equipment procurement decisions, and to target plant areas that are in need of noise control intervention. Some employers plot noise levels on a “contour map,” delineating floor areas by their dB levels. When monitoring indicates that the noise level in a particular contour has changed, it is taken as a sign that the machinery and/or work process has changed in the area and that further evaluation may be needed.

Engineering Noise Control

While OSHA does not stipulate the level of effort to be devoted to engineering noise controls or the types of controls which should be applied, the physical reduction of the noise energy, either at its source,

in its path, or at the worker, should be a major focus of noise management programs. Hearing protection and/or administrative controls should not supplant noise control engineering; the best solution, because it does not rely on employee behavior, is to reduce the noise itself, preferably at the emission source. However, in many cases where noise control is ineffective, infeasible (as on an airport taxi area), or prohibitively expensive, HPDs become the primary countermeasure.

There are many techniques used in noise control, and the specific approach must be tailored to the noise problem at hand. A noise control engineer is typically consulted to assist in the measurements, usually taken from spectrum analyzers, and in the selection of control strategies. Example noise control strategies include: (1) *isolation of the source* via relocation, enclosure, or vibration-damping using metal or air springs (below about 30 Hz) or elastomer (above 30 Hz) supports; (2) *reduction at the source or in the path* using mufflers or silencers on exhausts, reducing cutting, fan, or impact speeds, dynamically balancing rotating components, reducing fluid flow speeds and turbulence, absorptive foam or fiberglass on reflective surfaces to reduce reverberation, shields to reflect and redirect noise (especially high frequencies), and lining or wrapping of pipes and ducts; (3) *replacement or alteration of machinery*, examples include belt drives as opposed to noisier gears, electrical rather than pneumatic tools, and shifting frequency outputs such as by using centrifugal fans (low frequencies) rather than propeller or axial fans (high frequencies), keeping in mind that low frequencies propagate further than high frequencies, but high frequencies are more hazardous to hearing; and (4) *application of quieter materials*, such as rubber liners in parts bins, conveyors, and vibrators, resilient hammer faces and bumpers on materials handling equipment, nylon slides or rubber tires rather than metal rollers, and fiber rather than metal gears. Further discussion of these techniques may be found in Bruce and Toothman (1986),³³ and an illustration of implementation possibilities in an industrial plant appears in Figure 16.9. A final approach which has just recently become available to industry is *active noise reduction* (ANR) in which an electronic system is used to transduce an offensive noise in a sound field and then process and reintroduce the noise into the same sound field such that it is exactly 180 degrees out-of-phase with, but of equal amplitude to the original noise (Casali and Berger, 1996).²² The superposition of the out-of-phase “anti-noise” with the original noise causes physical cancellation of the noise in a target zone of the workplace. For highly repetitive, predictable noises, synthesis of the anti-noise, as opposed to transduction and reintroduction, may also be used. At frequencies below about 1000 Hz, the ANR technique is most effective, which is fortuitous since the passive noise control materials to combat low frequency noise, such as absorptive liners and barriers, are typically heavy, bulky, and expensive. At higher frequencies and their corresponding shorter wavelengths, the processing and phase relationships become more difficult and cancellation is less successful, although the technology is rapidly improving.

In designing and implementing noise control hardware, it is important that ergonomics be taken into account. For instance, in a sound-treated booth to house an operator, the ventilation system, lighting, visibility outward to the surrounding work area, and other considerations relating to operator comfort and performance must be considered. With regard to noise-isolating machine enclosures, access provisions should be designed so as not to compromise the operator/machine interface. In this regard, it is important that production and maintenance needs be met. If noise control hardware creates difficulties for the operators in carrying out their jobs, they may tend to modify or remove it, rendering it ineffective.

Personnel

As shown in Figure 16.7, multiple individuals play important roles in an industrial HCP, and the program should filter down from management personnel who must demonstrably support it. The key individual is the HCP coordinator (at the lower left in Figure 16.7), typically a permanent employee of the company but sometimes an outside consultant, who serves as the responsible individual and overseer for the program as well as its internal “champion.” This individual, if properly qualified, may also be responsible for implementation of certain aspects of the program, including noise monitoring, audiometry on employees, selection and purchase of hearing protection devices (HPDs), and other functions. The HCP coordinator often heads a hearing conservation committee with representatives from labor, management, plant engineering, and safety. The coordinator also serves as a link between management and the

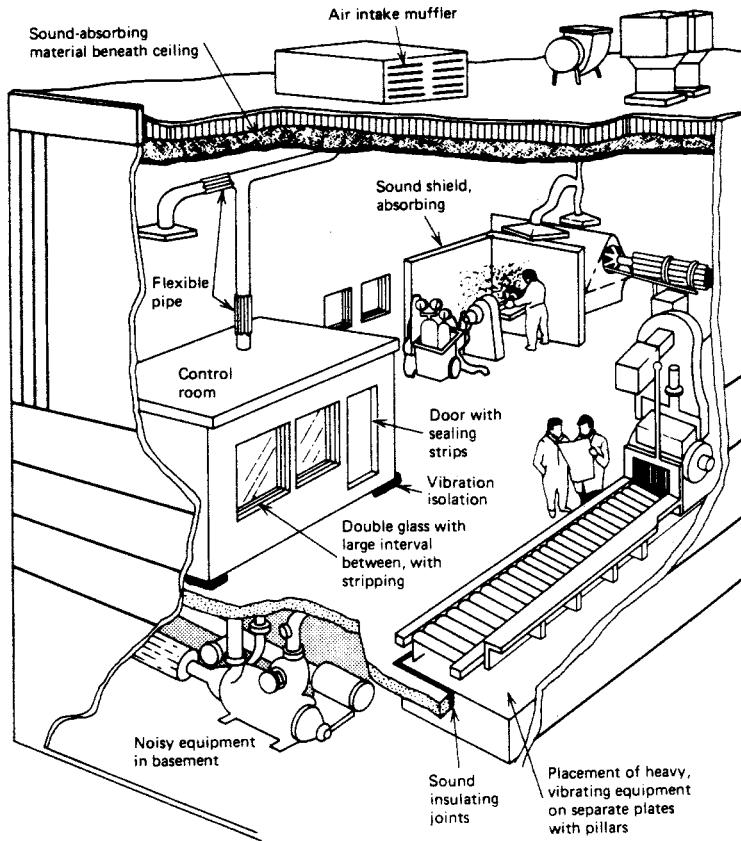

FIGURE 16.9 Examples of noise control implementation in an industrial plant. (Adapted from OSHA (1980). *Noise Control, A Guide for Workers and Employers*. Occupational Safety and Health Administration Report No. 3048. Washington, D.C., U.S. Department of Labor.)

workforce, and generally participates in management decisions which impact the noise environment or the HCP itself. For instance, one means of noise control is to establish a procurement policy which limits the decibel output of new equipment to a prespecified level; the HCP coordinator should be involved in such purchase decisions and in ensuring that criteria for noise emissions are met.

An audiologist, nurse, otolaryngologist, or other physician may conduct audiometric tests on employees and maintain a database for the test records. Industrial audiometry for OSHA purposes may also be conducted by a technician who is certified by the Council of Accreditation in Occupational Hearing Conservation (CAOHC), but this individual must ultimately be responsible to a professional audiologist or physician. The person who performs the audiometric test function may also be involved in helping the worker select an appropriate HPD (with input from the noise exposure records) and in educating and training the worker about the hazards of noise and the proper use of protection.

The work supervisor or foreman may also provide input to the HCP. For instance, in cases where workers are rotated on and off noisy machines to limit their exposures (a type of administrative countermeasure), the supervisor should be consulted to determine feasible rotation schemes. Furthermore, it is imperative that the supervisor exhibit good hearing conservation practice him/herself and provide specific feedback to the HCP coordinator about occurrences which impact the success of the HCP, such as a machine which has become noisy due to lack of maintenance or a worker who is uncomfortable with his/her assigned HPD and therefore repeatedly takes it on and off. Because of his/her close relationship and proximity to production employees, the foreman or supervisor can serve as a key individual in

helping to motivate the workers to exercise good hearing conservation practice, both by serving as a role model and an information resource.

Some large companies have an acoustical engineer on staff while others may need to hire such an individual when engineering noise control becomes necessary. The acoustical engineer can perform in-depth spectral analyses of specific noise sources and design noise control solutions. Furthermore, acoustical engineers can be helpful in the overall design of the HCP, in that the specialized knowledge they possess will be useful in considering tradeoffs in dollar-cost-to-dB reduction benefits when comparing various countermeasure strategies.

If the company has a safety engineer on staff, this individual should serve on the hearing conservation committee and participate in noise-related decisions that impact safety in other ways. For instance, if noise levels increase in an area where acoustic alarms signal the approach of an automated material transport vehicle, the safety engineer will need to work to increase the alarm's output to maintain detectability and/or use an alternate warning system, such as a flashing strobe, to maintain vehicle conspicuity. The safety engineer may also work with the HCP coordinator in selecting appropriate hearing protection for employees who must maintain communications in hazardous areas. In some small companies, the safety engineer may, in fact, have responsibility for the HCP itself.

Involvement and commitment of the proper hearing conservation and safety personnel, support of company management, and a trained and motivated workforce are all important to the success of a properly designed and implemented industrial hearing conservation program. Such a program can markedly reduce noise-induced distractions and interference on the job, and above all, prevent the tragic and irrecoverable occurrence of occupational hearing loss in workers.

References

1. Stevens, S. S. (1936). A scale for the measurement of a psychological magnitude: Loudness. *Psychological Review*, 43, 405-416.
2. Stevens, S. S. (1972). Perceived level of noise by Mark VII and decibels (E). *Journal of the Acoustical Society of America*, 51(2, pt. 2), 575-601.
3. Zwicker, E. (1960). Ein verfahren zur berechnung der lautstärke. *Acustica*, 10, 304-308.
4. Kryter, K. D. (1994). *The Handbook of Hearing and the Effects of Noise*. New York: Academic Press.
5. Sanders, M. S. and McCormick, E. J. (1993). *Human Factors in Engineering and Design*, 7th Edition, New York: McGraw-Hill.
6. Poulton, E. (1978). A new look at the effects of noise: A rejoinder. *Psychological Bulletin*, 85, 1068-1079.
7. Sorkin, R. D. (1987). Design of auditory and tactile displays, in Salvendy, G. (Ed.), *Handbook of Human Factors*, (pp. 549-576). New York: McGraw-Hill.
8. ANSI S3.5-1969 (R1986). *Methods for the Calculation of the Articulation Index*. New York: American National Standards Institute, Inc.
9. ISO 7731-1986 (E) (1986). *Danger Signals for Workplaces — Auditory Danger Signals*. Geneva, Switzerland: International Organization for Standardization.
10. Acton, W. I. (1970). Speech intelligibility in a background noise and noise-induced hearing loss. *Ergonomics*, 13(5), 546-554.
11. Pollack, I. (1958). Speech intelligibility at high noise levels: Effects of short-term exposure. *Journal of the Acoustical Society of America*, 30, 282-285.
12. Morrison, H. B. and Casali, J. G. (1994). Intelligibility of synthesized voice messages in commercial truck cab noise for normal-hearing and hearing-impaired listeners. *Proceedings of the 1994 Human Factors and Ergonomics Society 38th Annual Meeting*, Nashville, Tennessee, October 24-28, 801-805.
13. EPA (1981). *Noise in America: The Extent of the Noise Problem*. Environmental Protection Agency Report No. 550/9-81-101. Washington, D.C., EPA.
14. National Institutes of Health (NIH) Consensus Development Panel. (1990). Noise and hearing loss. *Journal of the American Medical Association*, 263(23), 3185-3190.

15. Melnick, W. (1991). Hearing loss from noise exposure, in C. M. Harris (Ed.), *Handbook of Acoustical Measurements and Noise Control*. (pp. 18.1-18.19). New York: McGraw-Hill.
16. Taylor, W., Pearson, J., Mair, A., and Burns, W. (1964). Study of noise and hearing in jute weavers. *Journal of the Acoustical Society of America*, 38, 113-120.
17. ANSI S1.4-1983 (R1994). *Specification for Sound Level Meters*. New York: American National Standards Institute, Inc.
18. Peterson, A. P. G. (1979). Noise measurements: Instruments, in C. M. Harris (Ed.) *Handbook of Noise Control* (pp. 5-1-5-19). New York: McGraw-Hill.
19. OSHA (1983). 29CFR1910.95. *Occupational Noise Exposure; Hearing Conservation Amendment; Final Rule*. Occupational Safety and Health Administration. *Code of Federal Regulations*, Title 29, Chapter XVII, Part 1910, Subpart G, 48 FR 9776-9785. Washington, D.C.: Federal Register.
20. Harris, C. M. (1991). *Handbook of Acoustical Measurements and Noise Control*. New York: McGraw-Hill.
21. Berger, E. H. and Casali, J. G. (1997). Hearing protection devices, in M. J. Crocker (Ed.) *Encyclopedia of Acoustics*. New York: Wiley.
22. Casali, J. G. and Berger, E. H. (1996). Technology advancements in hearing protection: Active noise reduction, frequency/amplitude-sensitivity, and uniform attenuation. *American Industrial Hygiene Association Journal*, 57, 175-185.
23. Park, M. Y. and Casali, J. G. (1991). A controlled investigation of in-field attenuation performance of selected insert, earmuff, and canal cap hearing protectors. *Human Factors*, 33(6), 693-714.
24. EPA (1979). 40CFR211, Noise labeling requirements for hearing protectors. Environmental Protection Agency, *Federal Register*, 44(190), 56130-56147.
25. NIOSH (1975). *List of Personal Hearing Protectors and Attenuation Data*. National Institute for Occupational Safety and Health-HEW Publication No. 76-120, 21-37. Washington, D.C.
26. ANSI S3.19-1974 (1974). *Method for the Measurement of Real-Ear Protection of Hearing Protectors and Physical Attenuation of Earmuffs*. New York: American National Standards Institute, Inc.
27. Berger, E. H., Franks, J. R., and Lindgren, F. (1996). International review of field studies of hearing protector attenuation, in A. Axelsson, H. Borchgrevink, R. P. Hamernik, P. Hellstrom, D. Henderson, and R. J. Salvi (Eds.), *Scientific Basis of Noise-Induced Hearing Loss*. (pp. 361-377), New York: Thieme Medical Publishers, Inc.
28. Royster, J. D., Berger, E. H., Merry, C. J., Nixon, C. W., Franks, J. R., Behar, A., Casali, J. G., Dixon-Ernst, C., Kieper, R. W., Mozo, B. T., Ohlin, D., and Royster, L. H. (1996). Development of a new standard laboratory protocol for estimating the field attenuation of hearing protection devices. Part I. Research of Working Group 11, Accredited Standards Committee S12, Noise. *Journal of the Acoustical Society of America*, 99(3), 1506-1526.
29. OSHA (1989). OSHA Instruction CPL 2.45B, June 15. *Field Operations Manual*. (pp. IV-33 — IV-35), Rockville, MD: Government Institutes, Inc.
30. OSHA (1990). OSHA Instruction CPL 2-2.20B, February 5. *Field Technical Manual*. (pp. 4-1 — 4-15), Rockville, MD: Government Institutes, Inc.
31. Royster, J. D. and Royster, L. H. (1986). Audiometric database analysis, in E. H. Berger, W. D. Ward, J. C. Morrill, and L. H. Royster (Eds.), *Noise and Hearing Conservation Manual* (pp. 293-317). Akron, OH: American Industrial Hygiene Association.
32. Zohar, D., Cohen, A., and Azar, N. (1980). Promoting increased use of ear protectors in noise through information feedback. *Human Factors*, 22(1), 69-79.
33. Bruce, R. D. and Toothman, E. H. (1986). Engineering controls, in E. H. Berger, W. D. Ward, J. C. Morrill, and L. H. Royster (Eds.), *Noise and Hearing Conservation Manual* (pp. 417-521). Akron, OH: American Industrial Hygiene Association.
34. Earshen, J. J. (1986). Sound measurement: Instrumentation and noise descriptors, in E. H. Berger, W. D. Ward, J. C. Morrill, and L. H. Royster (Eds.), *Noise and Hearing Conservation Manual* (pp. 38-95). Akron, OH: American Industrial Hygiene Association.
35. OSHA (1980). *Noise Control, A Guide for Workers and Employers*. Occupational Safety and Health Administration Report No. 3048. Washington, D.C.: U.S. Department of Labor.

17

Vibrometry

Donald E. Wasserman
D.E. Wasserman, Inc.

David G. Wilder
University of Iowa

17.1	Introduction	17-1
17.2	Vibration Basics	17-1
17.3	Vibration Measurements Basics	17-4
17.4	Occupational Vibration Standards/Guides.....	17-7
	Whole-Body Vibration Standards/Guides Used in the U.S. •	
	Hand-Arm Vibration Standards/Guides Used in the U.S.	
17.5	Summary	17-10

17.1 Introduction

There are some 8 million workers¹ in the U.S. exposed to occupational whole-body vibration (WBV) or hand-arm vibration (HAV) with resulting severe medical consequences of WBV or HAV exposures. The ability to measure, quantify, and evaluate the vibration impinging on the human body and relating these results to the disease processes it produces is essential to understanding both dose–response relationships and methods for controlling human vibration exposure. The purpose of this chapter is thus threefold: (1) to provide an introduction to the occupational vibration measurement process; (2) to provide a basic understanding of the occupational WBV and HAV health and safety standards/guides currently in use in the U.S.; and (3) to demonstrate the interrelationships between these measurements and their respective WBV and HAV standards/guides.

17.2 Vibration Basics^{2,3}

Vibration is a description of motion. As such, this motion is characterized by its direction *and* a corresponding magnitude; thus, by definition, vibration is a *vector quantity*. A total of six vectors are needed to describe vibrating motion measured at any one point; three of these vectors portray “linear motion” and are situated mutually perpendicular to each other; the remaining three vectors portray the rotational motion around each of these linear vectors and are called pitch, yaw, and roll. Currently pitch, yaw, and roll are not measured; only the three perpendicular linear vectors are measured and evaluated in human vibration work. Figure 17.1 shows the mutually perpendicular measure coordinate system used for WBV measurements. Similarly, Figure 17.2 shows the two coordinate systems used to measure HAV. We define the directions of motion as follows: The “Z axis” motion is in the long (head-to-toe) WBV direction, and for HAV measurements, the motion is a direction parallel to the hand/arm long bones. Similarly, the “Y axis” motion is in the direction across the shoulders for WBV measurements, and for HAV measurements, the motion is across the knuckles of the hand. Finally, the “X axis” motion is in the front-to-back direction (through the sternum) for WBV, and for HAV measurements, the motion is through the palm of the hand.

Having defined the directions of motion, the vibration magnitude or intensity parameter(s) must be specified. We can choose among three mathematically interrelated quantities: displacement, velocity, or acceleration. Displacement is merely the distance moved away from some reference position. Velocity (or speed) is the time-rate-of-change of displacement. *Acceleration* is the time-rate-of-change of velocity.

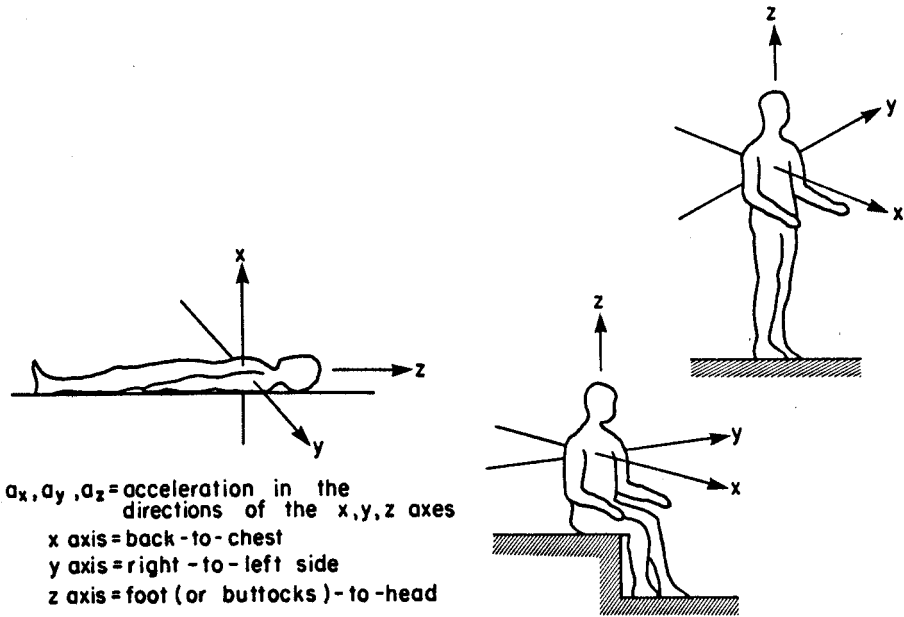

FIGURE 17.1 Whole-body vibration measurements coordinate system. (ANSI S3.18, ISO 2631, ACGIH-TLV (WBV), EU)

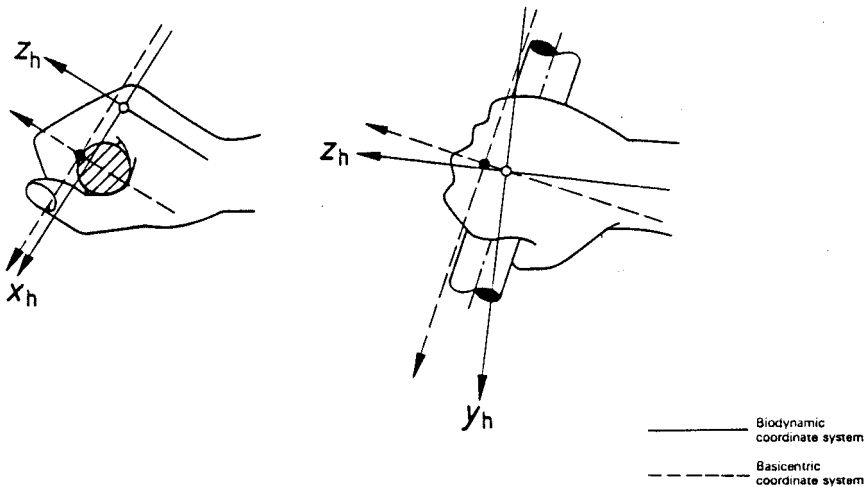

FIGURE 17.2 Hand-arm vibration measurements coordinate systems. (ANSI S3.34, ACGIH-TLV (HAV), EU, NIOSH #89-106)

Acceleration is usually the magnitude/intensity parameter of choice for several reasons which include ease of measurement and the belief that acceleration is both a hard and soft tissue stressor. Acceleration is expressed in units of meters/s/s or in terms of gravitational g units, where $1g = 9.81$ meters/s/s. The “peak” acceleration or maximum values are not usually evaluated, rather an average acceleration parameter called *root-mean-squared* or *rms* acceleration is measured and evaluated and is relatable directly to the human vibration standards. In the rms process the measured values of acceleration are squared and subsequently averaged to get its mean value. Finally, the square root is determined resulting in an acceleration value proportional to the vibration signal’s energy content (see Equation 1).

$$a_{\text{rms}} = \sqrt{\frac{1}{T} \int_0^T a^2(t) dt} \quad (1)$$

where a = acceleration (in g 's or m/sec^2); t = time (in seconds).

Vibration motion can repeat itself. This is called periodic motion. Motion need not repeat itself; it can be random or nonperiodic. The most basic form of motion is sinusoidal, or a pure tone if it were audible, which usually repeats itself; the rms value of a sinusoid is about 70% of its peak or maximum value. If a sinusoid completes its cycle in one second, before it begins to repeat itself, its vibration *frequency* is 1 Hertz (Hz); 10 Hertz simply means that 10 complete cycles have occurred in one second; two kilohertz (2 kHz) means that two thousand complete cycles have occurred in one second, etc. For WBV we are interested in a vibration frequency range (or bandwidth) of 1 to 80 Hz; for HAV the bandwidth of interest is from about 6 to 1400 Hz or 1.4 kHz; sometimes even higher extending up to 5000 Hz or 5 kHz. Since most motion appearing in the industrial environment is a compound mixture of many vibration frequencies at various acceleration levels, it is necessary to mathematically sort these frequencies into their individual sinusoidal frequencies and their corresponding magnitudes (see Equation 2). This computer process is called *Fourier Spectrum Analysis* and is required by most human vibration standards before they can be used.

$$F(t) = a_0 + a_1 \sin wt + a_2 \sin 2 wt + a_3 \sin 3 wt + \dots + a_n \sin(n) wt + \\ b_1 \cos wt + b_2 \cos 2 wt + b_3 \cos 3 wt + \dots + b_n \sin(n) wt \quad (2)$$

where a and b = amplitude values of each sinusoid at specific frequencies composing the spectrum; a_0 = dc term or zero Hertz value.

Specialized computers called Fast Fourier Transform (FFT) analyzers or real time analyzers (RTA) are used to transform the vibration mix into its discrete frequencies.⁴ Each such frequency is graphically displayed as a series of vertical lines or spectra; the position of each line identifies its vibration frequency in Hz and thus its place in the spectrum; the height of each line is a measure of its individual vibration acceleration intensity in g units or meters/s/s. The entire spectrum is the sum of all these lines. Vibrating tool spectra are quite unique, depending on the tool. Vehicle spectra from trucks, buses, trains, etc. are also unique.

The final concept to be discussed is called *resonance* (or natural frequency) which is an unwelcome situation where the conditions for transferring vibration from its source (i.e., tools, vehicles, etc.) to the human receiver are optimal. Thus, a very small magnitude of vibration impinging on a human or a structure (such as a bridge) causes an uncontrollably amplified response by the human or structure. This is the reason why bridges collapse if soldiers march in cadence across them. Unfortunately, we humans have resonances too, namely, in WBV 4 to 8 Hz for Z axis vertical vibration, 1 to 2 Hz in both the X and Y axes. Spinal resonance is 4.5 to 5.5 Hz.⁵ The hand-arm system seems to resonate in the 150 to 250 Hz range.³ In general, the larger the mass or weight of a structure, the lower the resonant frequency. Equation 3 is the resonance equation for a simple single-degree of freedom system consisting of motion in one direction consisting of a mass, spring, and damping element.

$$W = \sqrt{\frac{k}{m}} \quad (3)$$

where $W = 2\pi f$; k = spring constant; m = mass.

Resonance thus represents the Achilles heel of human response to vibration. As is the auditory system to sound, human response to vibration is therefore frequency dependent and nonlinear because at resonance the impinging vibration finds its easiest pathway to the person; at other vibration frequencies, the vibration pathway is not as easy and thus it requires more acceleration at a nonresonant frequency to produce the same level of human response.

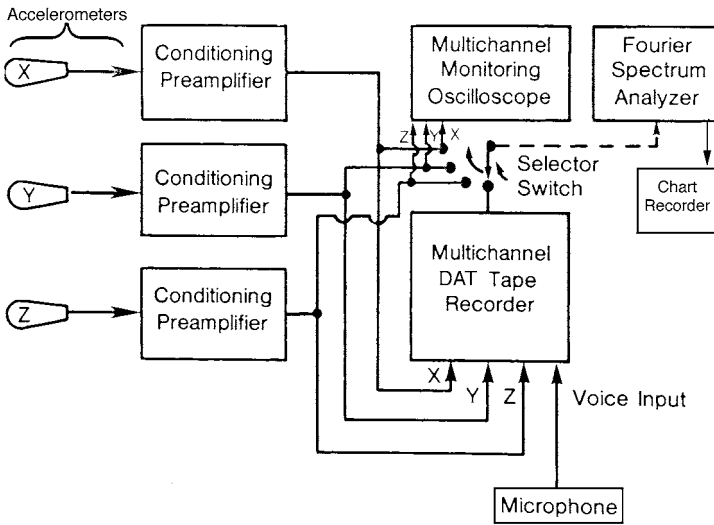

FIGURE 17.3 Basic triaxial vibration acceleration measuring system.

17.3 Vibration Measurements Basics²⁻⁴

The major reason for performing occupational vibration measurements is to evaluate the vibration impinging on persons. Evaluations are performed using the various WBV and HAV standards/guides. These standards/guides are the critical link between the various health and safety effects of WBV or HAV and the vibration hazard levels experienced by workers. It is important to note that there are many esoteric types of vibration measurements (i.e., mechanical: impedance, mobility, stiffness, compliance, etc.) and other methods of data analysis, such as modal analysis, but intentionally in this chapter we briefly describe only performing acceleration measurements as required by the applicable health and safety standards/guides in order to use them. Finally, note that since displacement, velocity, and acceleration are all mathematically linked, then from a measurement of acceleration, the velocity function can be derived by electronic integration; repeating the integration next on the velocity function yields the displacement function. Thus, if desired, an acceleration measurement can yield additional data.

Figure 17.3 shows a basic vibration acceleration measurement setup. Since we must *simultaneously* but separately measure in all three X,Y,Z axes acceleration data from a vibrating tool, for example, or from a driver's truck seat, three separate data channels are needed. Three perpendicularly mounted lightweight accelerometers are used to measure each axis acceleration, followed by three appropriate preamplifiers to amplify and electronically condition the tiny millivolt signals coming from each accelerometer. The outputs of each of these three X,Y,Z preamplifiers are then individually recorded and stored on a multitrack tape system known as a *digital audio tape* (DAT) for later Fourier spectrum analysis. It is also desirable to have: (1) a microphone/voice track on the DAT to note the chronology of events being recorded, and (2) an oscilloscope or similar device monitoring the X,Y,Z acceleration axes for possible signal overload conditions leading to distortion of the recorded signal(s) and resulting in erroneous data processing results. After the three channel or "triaxial" data have been measured, stored, and recorded, then a Fourier spectrum analysis can be performed separately on each data channel. Each spectrum is next separately evaluated using the appropriate standard(s). A key element in these measurements is the triaxial accelerometer.

Accelerometers are devices which convert mechanical motion into a corresponding electrical signal. Two distinctly different devices are used for occupational vibration measurements. For WBV measurements piezoresistive accelerometers are used; for HAV measurements piezoelectric or crystal accelerometers are used.

The former device works on the principle of an electronic four-arm electronic balanced bridge; P or N semiconductors form each of the bridge arms. All of these arms are bonded to one end of a tiny metal beam. The other end of this beam is bonded to a tiny metal mass or weight to which the force of vibration is applied. With no vibration present, the bridge is “balanced,” yielding zero output voltage. When vibration is applied to this tiny mass/beam combination, we obtain the acceleration of this mass against the beam because of the bending motion of the beam compressing some of the beam arms, thereby unbalancing the bridge, resulting in an electrical voltage proportional to acceleration; in effect we are calculating Newton’s second law, $F = ma$, with a vibration force and a known mass bonded to the metal beam. The acceleration signal is very small (millivolts) and needs to be amplified using a so-called difference or differential amplifier which measures and amplifies the voltage or potential difference across the arms of the Wheatstone bridge. The amplifier’s output voltage is next recorded by the DAT.

HAV measurements require a different type of accelerometer called a crystal, which is commonly found in nature. The crystal has a phenomenon called the piezoelectric effect; if a moving force is applied to the crystal, the crystal responds by generating a small electrical voltage across its face. The more intense the force, the larger the voltage generated. A crystal is a force-measuring device found in nature, not an accelerometer *per se*. If, however, a small weight or mass is bonded to the motion-sensitive surface of the crystal and the force of vibration is applied to this tiny mass, we have once again created an accelerometer, since, as before, it is the vibration force accelerating this mass against the crystal face which results in a corresponding voltage and charge proportional to acceleration. The acceleration signal is very small and needs to be amplified by a special charge amplifier whose output can then be recorded on a DAT recorder.

In either WBV or HAV measurements, the accelerometers must be of very light weight (less than 15 grams) and small; if not, measurement errors called mass loading result; the rule is that the total weight of the triaxial accelerometers, mounting fixture, cables, etc., must collectively be less than 10% of the weight of the object whose vibration is to be measured — a tool handle, for example. In all cases great care must be taken to avoid cable entanglement and/or breakage; the shortest possible cable length and integrity must be maintained especially from accelerometers to preamplifiers to ensure high quality and low electrical noise signals. In the case of HAV measurements, some crystal accelerometers can be purchased with built-in charge amplifiers to avoid some of these problems.

WBV measurements are usually made using an instrumentated hard rubber disc about the size of a pie plate (see Figure 17.4). The disc is placed between the top of the driver’s seat cushion and the buttocks. The center of the disc is hollow and contains three tiny accelerometers, mounted mutually perpendicular to each other to a small metal cube. The three piezoresistive accelerometer cables lead from the disc to preamplifiers and onto a DAT.

HAV measurements use three small lightweight crystal accelerometers mounted to a small metal cube, which in turn is usually welded to an inexpensive automotive hose clamp as shown in Figure 17.5. This hose clamp/accelerometer assembly is next clamped around the vibrating tool handle with the accelerometers placed very close to where the operator grasps the tool. Once again great care must be taken in arranging the three accelerometer cables such that the tool operator is free to perform the job safely during the vibration measurements.

To summarize, piezoresistive accelerometers are best suited to performing WBV measurements which are inherently very low frequency, low acceleration level measurements. Piezoelectric or crystal accelerometers are best suited to performing HAV measurements which require a wide bandwidth from a low of about 6 Hz to as high as 5,000 Hz; tool acceleration levels can be very high (several hundred g’s or more) and these devices must be able to measure these high g levels; these devices must be rugged, too. In all cases care with the accelerometer cabling must be taken. It is certainly not advisable to drop any of these devices on the ground or else they can be severely damaged and/or lose their calibration. Generally the manufacturer will supply a calibration sheet with a newly purchased accelerometer. It is advisable to use a portable calibrator as an added calibration safety measure just in case the accelerometer has been unknowingly damaged.

Obtaining vibration measurements requires careful planning and first performing a walk-through tour of the worksite to be measured, or the course a vehicle takes if its vibration is to be measured. Many

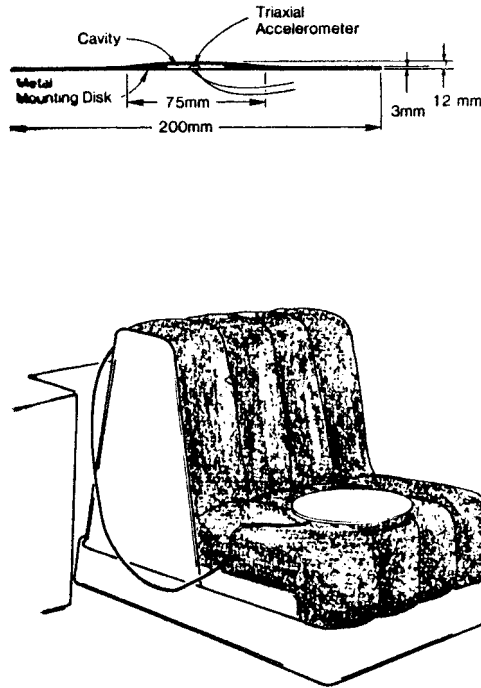

FIGURE 17.4 Whole-body vibration vehicle measurements using an instrumentated seat disc. (Adapted from Wasserman, D. 1987. *Human Aspects of Occupational Vibration*, Elsevier Publishers, Amsterdam, The Netherlands.)

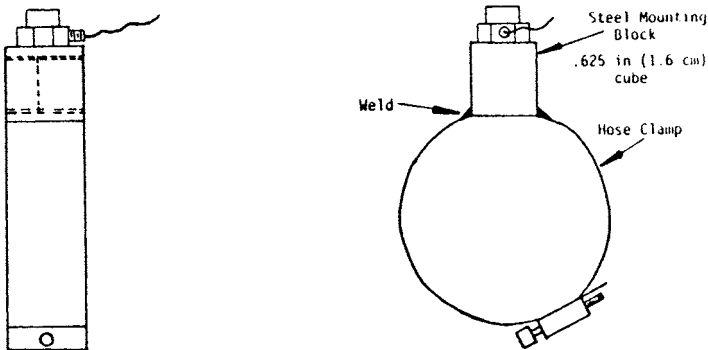

FIGURE 17.5 Hand-arm vibration tool measurements using an instrumentated automotive hose clamp. (Adapted from Wasserman, D. 1987. *Human Aspects of Occupational Vibration*, Elsevier Publishers, Amsterdam, The Netherlands.)

times, first using a video camcorder is a good way to record the details of how workers function on the job. Using the camcorder in real time while vibration measurements are obtained is also very useful for recalling the chronology of events of the test day. Finally, the minimum test time that vibration data are gathered and recorded is usually specified by the standard(s) which will be used. For example, most HAV standards require that a minimum time of one minute of continuous triaxial vibration acceleration data be collected and tape recorded per tool tested. The differences in WBV work situations and the so-called duty cycle to a large extent determine the minimum vibration measurement time. For example, the length of a complete work cycle for a delivery truck, or the duty cycle of a large vibrating metal stamping machine in a plant, are quite different and should be considered individually.

Finally, a word about handheld portable human vibration meters. We have briefly described measurement methods which will yield maximum usable information for the time and expense spent in gathering,

recording, and analyzing vibration data and then applying them to the human vibration standards (to be discussed next). These methods provide: (1) a permanent tape recording of the vibration data; (2) a computer spectrum analysis which provides a graphical picture of the vibration frequencies which comprise the spectrum; (3) the interaction and comparison of these spectra with these standards; and (4) numerical results indicating the total rms acceleration of the spectra. However, if only a single number total rms acceleration value for each axis is required, then there are handheld instruments available from two commercial manufacturers at this writing. The problem is that some of these instruments measure only one acceleration axis and the testing is stopped. The one accelerometer is reoriented in another axis and the testing is resumed. This is repeated until all three axes are recorded. This is *not* desirable since vibration virtually always moves *simultaneously* in all three axes; thus data can be lost as the one accelerometer is reoriented over and over again. One of the available commercial instruments has in a single handheld meter the desirable three accelerometers for simultaneous measurements of either WBV or HAV and also has triple output jacks for DAT recording and later spectrum analysis of the data. Thus, the reader should be very careful in the selection of a handheld vibration meter. Further, be aware that with the advent of miniaturized, high-density/high-speed, surface-mounted electronics technology, many of the above-mentioned functions (i.e., triaxial accelerometer and signal conditioning, data collection, analog-to-digital conversion, data storage, initial unweighted spectrum analysis/display, radio frequency remote control of functions) can all be performed onsite using rugged, battery-operated/stackable, miniature solid-state modules.

17.4 Occupational Vibration Standards/Guides¹

There are four whole-body vibration standards/guides and four hand-arm vibration standards/guides now in use in the U.S.:

1. International Standards Organization (Geneva, Switzerland), ISO 2631: *Guide to the Evaluation of Human Exposure to Whole-Body Vibration*, 1972-85.
2. American National Standards Institute (New York, NY), ANSI S3.18: *Guide to the Evaluation of Human Exposure to Whole-Body Vibration*, 1979.
3. American Conference of Government Industrial Hygienists (Cincinnati, Ohio), *ACGIH-Threshold Limit Values for: Whole-Body Vibration*, 1995-96.
4. European Union (EU, Luxembourg, Belgium), #89/392, 91/368EEC: (Whole-Body) *Vibration Standard*, 1989-91.
5. American National Standards Institute (New York, NY), ANSI S3.34: *Guide for the Measurement and Evaluation of Human Exposure to Vibration Transmitted to the Hand*, 1986.
6. American Conference of Government Industrial Hygienists (Cincinnati, Ohio), *ACGIH-Threshold Limit Values for: Hand-Arm Vibration*, 1984.
7. National Institute for Occupational Safety and Health (Cincinnati, Ohio), NIOSH Document #89-106: *Criteria for a Recommended Standard for Hand-Arm Vibration*, 1989.
8. European Union (EU, Luxembourg, Belgium), #89/392, 91/368EEC: (Hand-Arm) *Vibration Standard*, 1989-91.

Whole-Body Vibration Standards/Guides Used in the U.S.

ISO 2631 is the oldest standard, initially introduced in 1972. There have been several revisions over the years, but the basic evaluation criteria remain the same. In 1979, ANSI S3.18 was introduced; this document is virtually identical to the revised 1978 version of ISO 2631. In 1989–91 the EU essentially

¹Because of the differences and complexity of each occupational vibration standard/guide, the reader is encouraged to obtain, read, and understand the standard(s) which are to be used *before* collecting vibration data. Herein we can only discuss some of the major elements contained in these standards.

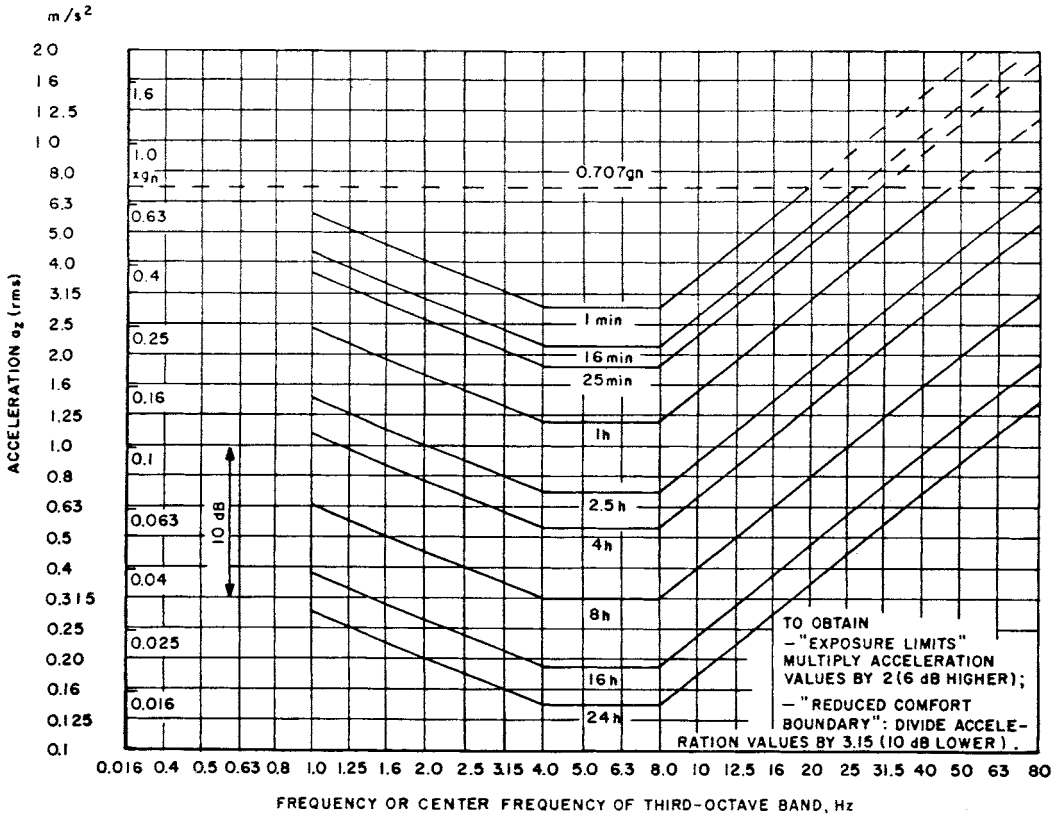

FIGURE 17.6 (FDP) Whole-body vibration curves for Z axis rms acceleration evaluation. (ANSI S3.18, ISO 2631, EU)

agreed with ISO 2631 and adopted a (weighted) vector sum triaxial acceleration level of 0.5 m/s/s as an action level for an 8 hr/day workplace WBV exposure level. In 1995–96, the ACGIH–TLV for WBV was introduced; it too uses the basic ISO 2631 curves, but the focus is mainly on occupation health and safety criteria and calculations, while ignoring the so-called comfort criteria. Since all of these standards use the same shape weighting curves, we begin there (refer to Figures 17.1, 17.6, and 17.7). All WBV acceleration measurements used in all these standards use the biodynamic coordinate system defined in Figure 17.1. Figure 17.6 is used to evaluate the Z axis (vertical) rms acceleration data. Figure 17.7 is used to separately evaluate: (1) the X axis rms acceleration data, and then (2) the Y axis rms acceleration data. In order to use these WBV standards, each axis of vibration acceleration data must be converted from the time domain in which it was collected to the frequency domain, which says a Fourier spectrum analysis must be performed separately for the X,Y,Z axes. Each spectrum is then formatted into 1/3 octave bands before it can be applied to the WBV standards. Once the foregoing has taken place, the data are then compared to (i.e., overlaid) the “weighted family of curves” shown in Figures 17.6 and 17.7. The abscissa in each of these figures is 1/3 octave band “vibration frequency” from 1 to 80 Hz. The ordinate in each of these figures is “vibration intensity” in rms acceleration in both meters/s/s or g’s, where 1 g = 9.81 m/s/s. Within each graph in Figures 17.6 and 17.7 are families of “weighted” parallel-time-dependent daily exposure curves which are called FDP or fatigue decreased proficiency curves. There are three levels of comparing these spectra to the ISO and ANSI standards that the acceleration data can be separately compared to: (1) the FDP curves as shown; (2) if we divide each of the FDP acceleration values by 10dB (3.15), we generate another family of similar curves called RC or reduced comfort; (3) if we double each value of the original FDP curves, we generate another family of similar curves called EL or exposure limits. These standards tell us that the RC curves should be used for WBV *comfort* criteria, such as in a

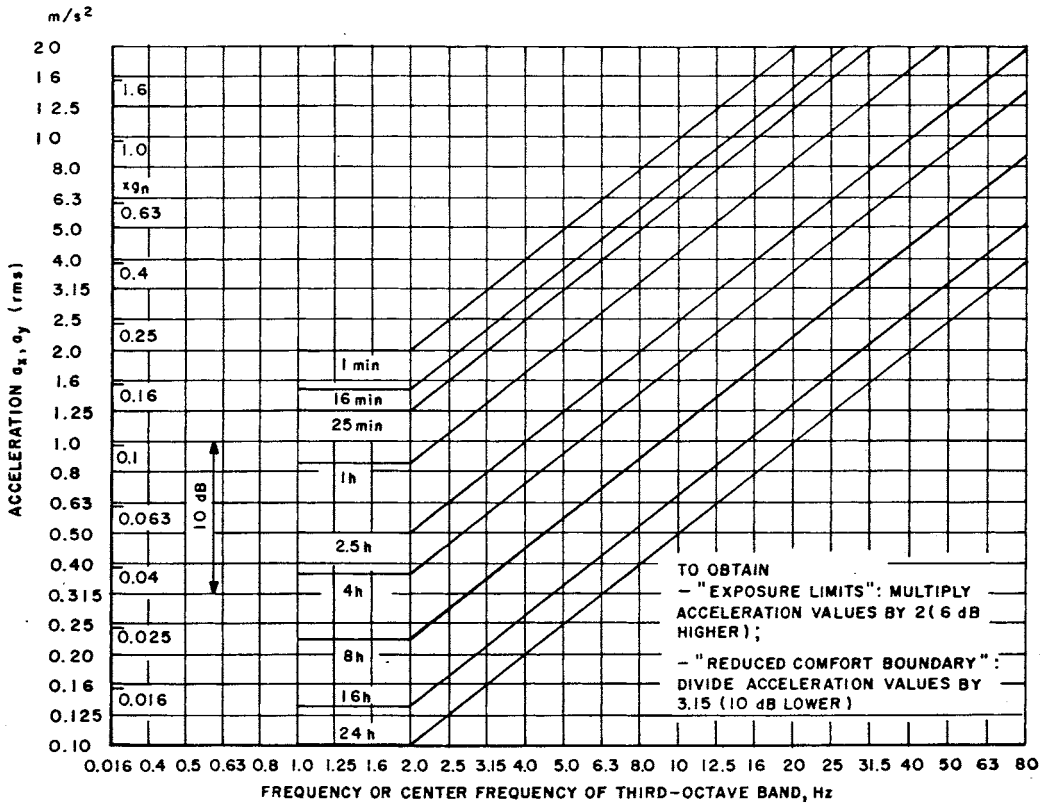

FIGURE 17.7 (FDP) Whole-body vibration curves separately used for X, Y axes rms acceleration evaluations. (ANSI S3.18, ISO 2631, EU)

vehicle ride situation; the FDP curves are operator fatigue level curves where *safety* may well be the issue; and finally the EL curves are concerned with WBV *health effects*. The U-shape of the family of the Z axis curves in Figure 17.6 emphasizes that resonance occurs in the 4 to 8 Hz band as shown by the trough of the curves for each of the daily exposure times. Higher daily rms acceleration levels are allowed at frequencies lower than 4 Hz and greater than 8 Hz since at resonance smaller input acceleration levels produce larger responses than would occur at other frequencies. Similarly, the format for Figure 17.7 shows elbow-shaped curves where the resonant frequency range in either the X or Y axes occurs at 1 to 2 Hz; higher acceleration levels are allowed for frequencies greater than 2 Hz. In actual use, vibration spectra are overlaid on, say, the FDP curves separately for the Z axis, Y axis, and X axis. If, for example, all of the Z spectra fall below the Figure 17.6 FDP curves, then the standard has not been exceeded for that axis; if one or more spectral peaks touch and/or exceed an FDP weighted curve, then the standard has been exceeded for that daily exposure time. The most severe axis is defined by the highest spectral peak(s) which intersect the FDP curves. As a matter of practice, FDP curves are mostly used for *both* health and safety, and the EL curves are *not* used because researchers believe these curves are not protective enough.^{2,6} Thus, the ACGIH-TLV for WBV uses only the FDP curves for health and safety, and they totally eliminate both the EL and RC curves. Further, the ACGIH-TLV for WBV then recommends using a weighted vector-sum calculation for all three axes to obtain a single number which is then compared to the 0.5 m/s/s action level established by the EU. In all of the cited WBV standards, if in any of the three axes, the vibration crest factor (defined as the peak acceleration divided by the rms acceleration in the same direction) is less than or equal to six, the standard can be used; values greater than six cause the standard to *underestimate* the true severity of the vibration hazard. This is particularly troublesome when a vehicle, for example, goes off road and traverses numerous very steep bumps at fast speeds.

There are other methods for evaluating WBV exposure. For example, there are those who believe that the WBV severity is best described by equations raised to the fourth power of acceleration;⁷ actual data support the notion that mostly subjective discomfort is best described by this fourth power concept since there is little hard epidemiological evidence at this writing to show that this concept applies to worker health. Finally, the reader should be aware that there are various proposals to revise ISO 2631, which may occur in the future.

Hand-Arm Vibration Standards/Guides Used in the U.S.

Figure 17.8 shows the HAV weighting curves used in ANSI S3.34 where each of the three X,Y,Z axes is evaluated using the same graph by overlaying each spectrum separately over Figure 17.4; as before, this standard is exceeded if one or more spectral peaks in any of the axes touch or exceed one or more of the exposure time dependent curves; the ACGIH-TLV for HAV uses the same “shape” weighted curve but requires that each axis yield a numerical weighted sum, each of which is next compared to the acceptable values of HAV daily exposure given in Table 17.1. The EU standard also requires that each of these numerical weighted values or their weighted sum be compared to the 2.5 m/s/s “action level.” Notice that the format of Figure 17.8 is similar to the formats of Figures 17.6 and 17.7, where the abscissa is vibration frequency, in 1/3 octave bands, from 5.6 to 1250 Hz and the ordinate is vibration intensity in acceleration. All standards use the HAV measurement coordinate system previously shown in Figure 17.2 with the “basentric system” the method of choice. Except for NIOSH #89-106, all of the above standards use this same “elbow shaped” weighting given in Figure 17.8.

The NIOSH standard is an interim standard without stating any acceptable acceleration level limit at any frequency; this standard asks for each axis that: (1) weighted HAV acceleration values from 5.6 to 1250 Hz be calculated, (2) unweighted acceleration values from 5.6 to 5000 Hz be calculated, and (3) the weighted and unweighted be compared in view of the severity of the prevalence of the hand-arm vibration syndrome (HAVS) determined by using the tool(s) from whence these acceleration measurements were made. NIOSH has chosen to issue this interim standard because there is an anomaly in the other HAV standards, namely that the HAV weighting network shown in Figure 17.4 was originally developed using older vibrating tool types commonly found in the workplace. Over the last few years, some very high speed vibrating hand tools have been introduced, some of which have spectral peaks extending to 5000 Hz and above. Current standards end at 1250 Hz, and hence in a few instances the current standards would rule these very high-speed tools as acceptable when that may not be the case. NIOSH has chosen to keep their interim standard, until this anomaly is resolved.

The architects of the other HAV standards are carefully making adjustments to their standards with regard to the special case of these very high-speed tools as the vibration data and corresponding HAVS health data become available. We recommend the use of ANSI S3.34, ACGIH-TLV for HAV and the EU criteria since all provide good overall guidance, and in the special case where very high-speed tools are to be tested, *caution* is advised when evaluating the triaxial vibration test data.

17.5 Summary

In this chapter the basic concepts of displacement, velocity, acceleration, resonance, coordinate systems for measurements, and spectrum analysis are presented and integrated for an understanding of their application to whole-body and hand-arm occupational vibration. Generic acceleration measurement systems and methods are discussed, which include piezoelectric and piezoresistive accelerometers, conditioning preamplifiers, data recording systems, and Fourier spectrum computers. The chapter concludes with a discussion of the various occupational whole-body and hand-arm vibration standards/guides currently used in the U.S. and their application to the evaluation of triaxial acceleration data from the workplace; because of the complexity of each standard, users are encouraged to obtain copies of standards which are to be used before obtaining vibration data.

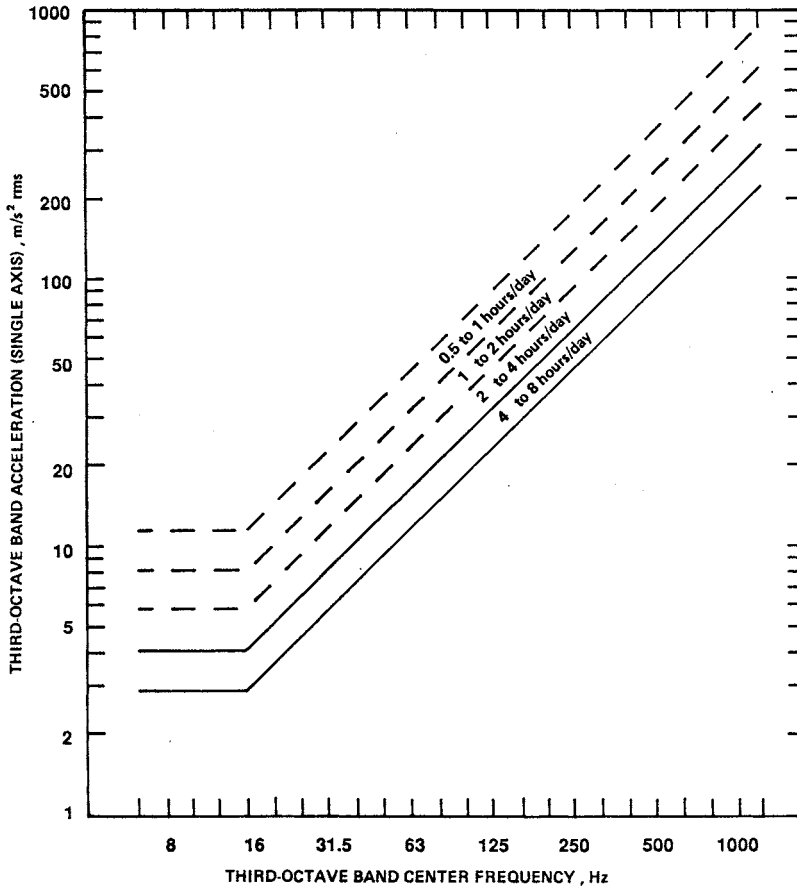

FIGURE 17.8 Hand-arm vibration curves for the separate evaluation of X,Y,Z axes rms accelerations (see text). (ANSI S3.34)

TABLE 17.1 ACGIH Threshold Limit Values for Exposure of the Hand to Vibration in X, Y, Z Directions

Total Daily Exposure Duration*	Values of the Dominant, [†] Frequency-Weighted, rms, Component Acceleration Which Shall Not Be Exceeded	
	a_{kv} (a_{keq})	
	m/s ²	g
4 hours and less than 8	4	0.40
2 hours and less than 4	6	0.61
1 hour and less than 2	8	0.81
Less than 1 hour	12	1.22

Note: 1 g = 9.81 m/sec²

* The total time vibration enters the hand per day, whether continuously or intermittently.

[†] Usually one axis of vibration is dominant over the remaining two axes.

If one or more vibration axes exceed the Total Daily Exposure then the TLV has been exceeded.

Courtesy of ACGIH

Defining Terms

Acceleration: The time rate of change of velocity of a moving object.

Accelerometer: A device designed to convert mechanical motion into a corresponding electrical analog voltage, charge, or current proportional to acceleration.

Conditioning Preamplifier: An electronic solid state amplifier designed to faithfully amplify, both in amplitude and frequency bandwidth, the minute electrical signals emanating from an accelerometer. Some preamplifiers are called “charge amplifiers” and convert the voltage generated across the face of a crystal (piezoelectric) accelerometer into corresponding charge, thereby allowing long cables to be used for measurements without loss of signal. Other preamplifiers are called “differential amplifiers,” which act as an amplifying voltmeter when used with “piezoresistive” type accelerometers.

DAT or Digital Audio Tape: A new type of instrumentation tape system with large dynamic input range and wide frequency bandwidth, whereby an analog input signal is converted and stored on a cassette tape in digital format. The original signal so stored can be retrieved either in digital format or reconverted again into its original analog version.

Displacement: Movement traversed away from a reference position.

Fourier Spectrum Analysis: The analysis of vibration data by mathematically converting time domain information into its corresponding frequency domain; the underlying assumptions are that the data are linear and that time domain information can be dissected and represented as a mathematical series of elemental sines and cosines. Computers which perform this function are called Fast Fourier Transform (FFT) analyzers or Real Time Analyzers (RTA).

Resonance: The tendency of an object to (1) move in concert with an external vibrating source and (2) to internally amplify the impinging vibration from that source; resonance is the optimum energy transfer condition between the source and the receiver.

Vector Coordinate System: A mutually perpendicular set of vectors, originating at the same motion point, which define the vector motion of that point. Typically, there are three linear and three rotational vectors which comprise motion at a point.

Vector: A mathematical quantity defined by both its magnitude and direction.

Velocity: The time rate of change of displacement of a moving object. Also called speed.

Vibration: At any one point, vibration is motion defined by six vectors, three mutually perpendicular linear vectors and three rotational vectors moving around these linear vectors (pitch, yaw, roll).

References

1. Wasserman, D., Badger, D., Doyle, T., and Margolies, L. 1974. Industrial vibration — An overview. *J. Am. Soc. Safety Engrs.* 19(6):38-43.
2. Wasserman, D. 1987. *Human Aspects of Occupational Vibration*, Elsevier Publishers, Amsterdam, The Netherlands.
3. Pelmeur, P. and Wasserman, D. 1998. *Hand-Arm Vibration: A Comprehensive Guide for Occupational Health Professionals*, Second edition, OEM Press, Beverly Farms, MA.
4. Thalheimer, E. 1996. *Practical Approach to Measurement and Evaluation of Exposure to Whole-Body Vibration in the Workplace*. Conference Proceedings: Seminars in Perinatology, International Conference on Pregnant Women in the Workplace Sound and Vibration Exposure, Univ. of Florida, Gainesville, FL.
5. Wilder, D., Wasserman, D., Pope, M., Pelmeur, P., and Taylor, W. 1994. Chapter 4: Vibration, in *Physical and Biological Hazards of the Workplace*, Eds. P. Wald and G. Stave, p. 64-83. Van Nostrand Reinhold, New York, NY.
6. Bovenzi, M. and Betta, A. 1994. Low-back disorders in agricultural tractor drivers exposed to whole-body vibration and postural stress. *Appl. Ergonomics* 25(4): 231-241.
7. Griffin, M. 1990. *Handbook of Human Vibration*. Academic Press, London, U.K.

For Further Information

Some of the cited references are comprehensive and excellent sources of information. Reference 2 is principally a WBV and HAV measurements, evaluation, and control textbook. Reference 3 is principally a medical textbook on HAV with some measurements and control information; reference 5 is a basic and comprehensive book chapter for both WBV and HAV; reference 7 is a very complete tome on WBV and HAV, but definitely not for the beginner.

The WBV or HAV standards cited in this chapter can be obtained from the following:

TLVs from: American Conference of Government Industrial Hygienists, 1330 Kemper Meadow Drive, Cincinnati, Ohio 45240 (Telephone: 513-742-2020).

ISO and ANSI Standards from: Standards Secretariat, Acoustical Society of America, 120 Wall St., 32nd. Floor, New York, NY 10005 (Telephone 212-248-0373).

NIOSH HAV Standard #89-106 write to: NIOSH Publications Dept. Taft Labs. 4676 Columbia Parkway, Cincinnati, Ohio 45226.

European Union Standards write to: Commission des Communautés Europeennes, Direction generale emploi, relations industrielles et affaires sociates: Batiment Jean Monnet-L-2920 Luxembourg, Belgium.

18

On the Behavioral Basis for Stress Exposure Limits: The Foundational Case of Thermal Stress

18.1	Introduction	18-2
18.2	Physiological Measures and Standards	18-2
	Heat Exchange with the Environment • Human Thermoregulation • Effects of Heat Stress on Health • Heat Acclimatization • Measurement of Heat Stress • Metabolic Heat Measurement • Physiological Exposure Limits to Heat Stress	
18.3	The Prevalence of Heat Stress	18-13
18.4	The Foundation for Exposure Criteria to Occupational Stress	18-13
18.5	Current Criteria: Derivations and Limitations	18-14
18.6	Single Versus Multiple Thresholds for Criteria	18-18
18.7	A New Descriptive Framework	18-24
18.8	Theoretical Foundation of the Limits Derived	18-28
18.9	Implications for All Stress Criteria	18-29
18.10	Summary and Conclusions	18-30

Peter A. Hancock
University of Minnesota

Ioannis Vasmatazidis
iNautix Technologies, Inc.

Abstract

In this work, we seek to expand the basis for understanding the limits for worker stress exposure. We wish to challenge the fundamental basis upon which many occupational exposures are founded. It is our contention that performance level should be considered as the principal criterion for exposure. Change in behavioral performance efficiency is the most sensitive reflection of human response to stress. Understanding these forms of response is a critical component in the development of indices of incipient stress effects and should expand and augment our traditional measurements of physiological functioning. Efficient and error-free performance is the principal criterion of contemporary work, especially in high-technology systems. Therefore, continuing exposure after work performance efficiency begins to fail, but before current physiological limits are reached, is inappropriate for both the safety and the productivity of the individual worker, his colleagues, and the systems within which they operate. Behavioral performance assessment should therefore be integrated with current physiological assessments to provide the primary exposure criterion. An examination of these performance thresholds for heat stress is presented together with its

fundamental theoretical foundation. This foundation is applicable to all forms of stress. These performance limits are of growing and now primary importance for prescriptions to all forms of occupational exposure and are critical necessities for future statements concerning comprehensive protective safety standards.

18.1 Introduction

The origins of contemporary occupational stress exposure standards are founded upon a knowledge of the characteristics and limitations of different facets of the human physiological system. The study of such processes and responses has traditionally fallen within the realm of occupational health and safety. Together, the ergonomist, the safety specialist, and those in occupational medicine have sought to enact standards which protect the individual worker against physiological damage. This perspective directly accords with the early nature of industrial work, where the principal demand was for physical effort. In essence, the currency of heavy industrial work was physiological effort. However, contemporary commercial work demands have changed from largely physical to largely cognitive requirements. Despite this fundamental change, current stress standards are still based upon assumptions principally concerning physiological detriment. Unfortunately, this is now insufficient as a basis for a full exposure standard for the larger spectrum of contemporary work.

We propose that health and safety exposure standards should be based primarily upon behavioral response, that being measures of task performance itself. Such measures provide a more sensitive metric of performer condition and are directly relevant to all aspects of human work, be they predominantly physical or cognitive in nature. Since performance productivity is the central measure of output across a wide spectrum of industrial work, the transfer of focus from physiological protection to performance assessment is liable to experience ready acceptance. In addition, setting standards with respect to performance begins to deal with the highly problematic issue of interactions between stresses. These are typically referred to in many standards documents; however, the lack of data and readily observable and consistent patterns of interactive effects means that, in reality, most efforts are directed to understanding one single source of occupational stress at a time. Obviously, this unidimensional approach does not include the combination of stresses actually experienced at work, and the use of behavioral outcomes can consequently begin to present a more complete picture of protection against the spectrum of stresses that do occur. In this chapter, we present a detailed articulation of this perspective with respect to one form of occupational exposure, namely, heat stress. Our purpose is to show how this specific stress can represent a prototype for safety and health criteria for a wide range of occupational conditions. The general approach upon which this position is based is discussed, as is the global application of this concept to widespread forms of occupational stress. However, since the purpose of the present text is to provide researchers and practitioners alike with a complete picture of heat stress effects, we begin with an overview of the traditional physiological approaches to understanding thermal problems and protection against their adverse effects in occupational environments.

18.2 Physiological Measures and Standards

Despite the improvements in environmental controls, heat stress problems are not uncommon in contemporary workplaces. Thermal stress represents a threat to the human physiological system, and prolonged exposure can cause permanent physical damage and even death. As we show, experimental studies have shown that exposure to heat stress below the level of physiological threat have detrimental effects on cognitive performance and may result in operator error which leads to accidents that can affect more than the exposed worker alone. We (Hancock and Vasmatazidis, 1998) have proposed, and continue to argue here, that performance-based criteria should be developed to at least augment the existing physiology-based criteria. These additional criteria are presented later in this work. However, to understand the physiological effects of heat stress, the ergonomics practitioner has to have a basic knowledge of the thermoregulatory mechanisms of the human body, and the avenues by which humans exchange heat

with the environment. Several engineering and administrative control methods can then be implemented to optimize this heat exchange and thus reduce or eliminate the adverse effects of heat stress.

Heat Exchange with the Environment

The avenues by which the human body exchanges heat with the environment are:

Conduction. Heat transmission by conduction occurs during direct contact between the skin and various objects (floor, stone, hot kitchen appliances, etc.). Heat flows from the skin to colder objects (sensation of cold), or vice versa (sensation of warmth). Heat exchange by conduction is, in general, of low magnitude due to the insulating properties of clothing. In cold workplaces, however, the hands, which are frequently the main source of a worker's interaction with the environment, can come into contact with tools and cold surfaces. In extreme conditions, conductive heat loss through the hands should be prevented or reduced by using gloves.

Convection. Is essentially similar to conduction; however, the medium of the exchange of heat is through the air. The magnitude of convection effects depends upon the temperature difference between the skin and the surrounding air, as well as the air velocity.

Evaporation. When conduction and especially convective heat loss are insufficient to remove body heat, a further avenue of heat loss, evaporation, begins to come into operation. Sweat evaporation is the diffusion of water vapor through the epidermis (the outer level of skin) and water vapor exhaled from the lungs during respiration. Sweat evaporation is the predominant heat loss mechanism. As sweat evaporates, it absorbs heat from the skin which generates a cooling sensation. One effect of continued sweat evaporation is fluid loss. If this loss continues without replacement for an extended time, some symptoms of heat illness begin to appear. The ergonomist should be careful to provide fluid replacement, and despite many claims to the contrary, the most easily obtainable and useful replacement is water. The ergonomist should be aware that voluntary drinking does not necessarily always replace all the fluid lost. Indeed, in very hot environments such replacement is physically difficult to do, requiring almost constant drinking. Therefore, much care should be exercised in supervising workers who are exposed on a daily basis to very high temperatures since chronic fluid loss over a prolonged period can result in some of the heat illnesses we discuss below.

Radiation. Radiation represents transmission of heat from hot to cold objects by means of electromagnetic waves of relatively long wavelength. Colder objects absorb the wavelength transmitted by hotter objects, and convert them into thermal energy. Radiation depends mainly on the temperature difference between the skin surface and the surrounding surfaces. In general terms, the most potent source of radiant heat exposure for most workers is the sun. Prolonged exposure to its harmful level of various forms of radiation will result in adverse effects beyond heat problems alone.

In calculating the effects of different forms of thermal stress, it is possible to use the simple heat balance equation developed by Burton (1934), which defines the heat balance state of the human body as:

$$S = M - E \pm R \pm C - W$$

where

S = is bodily heat storage expressed either as the rate of heating (+) or cooling (-) in the body,

M = is the rate of bodily metabolic heat production,

E = is the rate of evaporative heat loss,

R = is the rate of heat gained (+) or lost (-) by radiation,

C = is the rate of heat gained (+) or lost (-) by convection, and

W = is the rate of work accomplished.

When $S = 0$ the body is said to be in the state of balance or thermal equilibrium. In conditions of heat stress, heat storage takes place, and S is positive. In conditions of cold stress, the body loses heat to the environment, and S is negative.

Human Thermoregulation

Human beings are *homeothermic*. They maintain a constant internal body temperature, also known as the *core* temperature of approximately 98.6°F or 37°C. Human body temperature is a distributed function and varies dynamically across the surface of the body and within the body as immediate and long-term adjustments are made to the conditions the individual faces. Deep body temperature, or core temperature, is the value most individuals refer to when they consider human thermal state. Such core temperature is usually measured experimentally by means of a probe which assesses rectal or ear (tympanic membrane) status. These provide a measure as close as possible of the temperature of the main organs of the body. However, these are often either uncomfortable or unacceptable as measures for prolonged working conditions and more recent sophisticated techniques are now available to provide remote monitoring of worker physiological status. In normal (i.e., thermoneutral) conditions, the skin temperature of a clothed person ranges between 31°C and 33°C. The necessary heat to maintain this level of temperature is generated as a by-product of metabolic processes which convert the chemical energy of foods into mechanical energy (work). Under fluctuations of the environmental thermal conditions, body temperature is regulated through change of the blood flow to the periphery (skin): sweating and shivering.

The hypothalamus of the brain is considered to be the coordinating center for thermoregulation. Thermoregulatory mechanisms are activated in two ways. First, by peripheral input provided by heat sensitive nerves (thermoreceptors) in the skin. Second, by direct stimulation of the hypothalamus which contains cells that are extremely sensitive to the blood temperature perfusing the hypothalamus. In either case, the hypothalamus responds by invoking those mechanisms that will maintain the core temperature at a dynamically constant level. In thermally neutral environments (air temperature about 20°C to 23°C for a resting and normally clothed person), the heat balance in the body is maintained by regulation of the blood flow. In warm environments, the body's first line of defense is increased blood circulation toward the periphery. Increased blood flow in the skin dissipates the excessive body heat into the environment, and maintains the heat balance of the body. At higher temperatures (or during intense exercise), sweating is invoked. Evaporation of sweat is more efficient under conditions of low relative humidity. Under excessive heat stress, the sweating mechanism fails and heat accumulates in the body over time. This condition is known as *hyperthermia* and is characterized by a life-threatening rise in the core temperature.

In slightly cold environments, the body responds by restricting heat flow toward the skin therefore preventing bodily heat from dissipating into the environment. At lower temperatures, the body generates additional heat through rapid muscular contractions known as shivering. Shivering is an action designed specifically to raise the temperature of the body and is one of the few cases of reflexive movement with no goal of affecting the external environment. Under extreme cold stress, thermoregulation fails, and the body is continuously losing heat to the environment. This condition, known as *hypothermia*, eventually causes death. The mechanisms by which this happens are complex, and some experiments to determine such tolerance have an unusual and reprehensive history in the story of scientific research (see Burton and Edholm, 1955).

The range of environmental conditions invoking the various types of thermoregulatory responses can be described by three zones (Grandjean, 1988; see also Figure 18.1):

1. *Zone of thermal comfort or vasomotor regulation.* Within this zone the body maintains thermal equilibrium by regulating the flow of blood to different parts of the body. For a clothed and resting person in winter this zone lies between 20°C and 23°C.
2. *Zone of heat regulation.* Within this zone, increasing ambient temperature invokes the thermoregulatory mechanisms against heat stress: (a) increased blood circulation in the skin, and (b) sweating. If heat stress continues to increase and exceeds the level of heat tolerance, the core temperature rises steeply and death by heat stroke is possible.
3. *Zone of bodily cooling.* Within this zone, decreasing ambient temperature invokes the thermoregulatory mechanisms against cold stress: (a) restricted blood circulation in the skin, and (b) shivering. As cold stress progresses, body temperature becomes lower than the body can tolerate, and death due to freezing is possible.

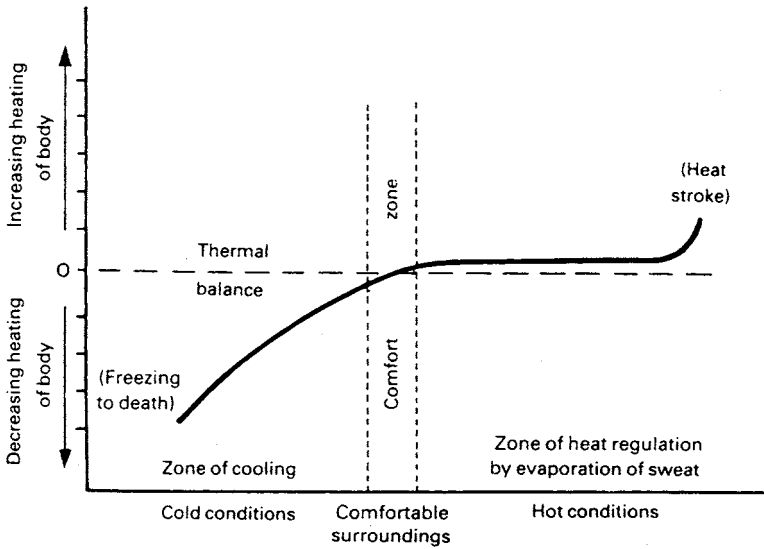

FIGURE 18.1 Zones of thermoregulation. (From Grandjean, E. 1988. *Fitting the Task to the Man*. 4th Edition. Taylor and Francis: New York. With permission.)

Effects of Heat Stress on Health

Exposure to heat stress can cause the following heat disorders and illnesses:

1. *Behavioral disorders.* These include transient heat fatigue that impairs skill and sensorimotor performance, and chronic heat fatigue resulting in permanent reduction of performance capacity.
2. *Skin eruptions.* They can take the form of heat rashes (tiny raised red vesicles) or anhidrotic heat exhaustion (gooseflesh areas of skin that do not sweat upon heat exposure).
3. *Heat cramps.* Painful spasms of muscles used during work caused by depletion of salt.
4. *Heat exhaustion.* Caused by dehydration, depletion of circulating blood volume, and/or competing demands for blood flow by the skin and active muscles (includes fatigue, nausea, headache, and giddiness).
5. *Heat syncope.* Caused by pooling of blood in dilated vessels of skin and lower parts of the body. It may cause fainting while standing erect and immobile in the heat.
6. *Heat stroke.* This condition represents failure of the sweating mechanism and is accompanied by a rectal temperature of 40.5°C or higher. Symptoms include confusion, loss of consciousness, convulsions, and continuous rise of core temperature. Heat stroke can cause death if treatment is not applied immediately.

Table 18.1 summarizes the range of heat-related disorders and illnesses, their predisposing factors, symptoms, treatments, and means of prevention.

Heat Acclimatization

Exposure of the human body to a hot environment over a long period of time brings about a physiological adaptation known as heat acclimatization. A heat-acclimatized body can better cope with the adverse effects of heat stress than a nonacclimatized body. Acclimatization can take place naturally; and we all develop some degree of heat acclimatization over a hot summer. In hot workplaces, however, acclimatization of the worker can be attained by a gradually increasing exposure to the heat over a period of weeks. In this case, the body develops the following adaptations:

TABLE 18.1 Heat Stress Illnesses and Disorders

Category and Clinical Features	Predisposing Factors	Underlying Physiological Disturbance	Treatment	Prevention
<p>1. Temperature Regulation Heatstroke</p> <p>Heatstroke: (1) Hot dry skin usually red, mottled or cyanotic; (2) Rectal temperature 40.5 C (104 F) and over; (3) Confusion, loss of consciousness, convulsions, rectal temperature continues to rise, fatal if treatment delayed</p>	<p>(1) Sustained exertion in heat by unacclimatized workers; (2) Lack of physical fitness and obesity; (3) Recent alcohol intake; (4) Dehydration; (5) Individual susceptibility; and (6) Chronic cardiovascular disease</p>	<p>Failure of the central drive for sweating (cause unknown) leading to loss of evaporative cooling and an uncontrolled accelerating rise in t_{re}, there may be partial rather than complete failure of sweating</p>	<p>Immediate and rapid cooling by immersion in chilled water with massage or by wrapping in wet sheet with vigorous fanning with cool dry air, avoid overcooling, treat shock if present</p>	<p>Medical screening of workers, selection based on health and physical fitness, acclimatization for 5–7 days by graded work and heat exposure, monitoring workers during sustained work in severe heat</p>
<p>2. Circulatory Hypostasis</p> <p>Heat Syncope</p> <p>Fainting while standing erect and immobile in heat</p>	<p>Lack of acclimatization</p>	<p>Pooling of blood in dilated vessels of skin and lower parts of body</p>	<p>Remove to cooler area, rest recumbent position, recovery prompt and complete</p>	<p>Acclimatization, intermittent activity to assist venous return to heart</p>
<p>3. Water and/or Salt Depletion</p> <p>(a) Heat Exhaustion</p> <p>(1) Fatigue, nausea, headache, giddiness; (2) Skin clammy and moist; complexion pale, muddy, or hectic flush; (3) May faint on standing with rapid thready pulse and low blood pressure; (4) Oral temperature normal or low but rectal temperature, usually elevated (37.5–38.5°C) (99.5–101.3°F); water restriction type: urine volume small, highly concentrated; salt restriction type: urine less concentrated, chlorides less than 3g/L</p> <p>(b) Heat Cramps</p> <p>Painful spasms of muscles used during work (arms, legs, or abdominal); onset during or after work hours</p>	<p>(1) Sustained exertion in heat; (2) Lack of acclimatization; and (3) Failure to replace water lost in sweat</p>	<p>(1) Dehydration from deficiency of water; (2) Depletion of circulating blood volume; (3) Circulatory strain from competing demands for blood flow to skin and to active muscles</p>	<p>Remove to cooler environment, rest recumbent position, administer fluids by mouth, keep at rest until urine volume indicates that water balances have been restored</p>	<p>Acclimatize workers using a breaking-in schedule for 5–7 days, supplement dietary salt only during acclimatization, ample drinking water to be available at all times and to be taken frequently during work day</p>
	<p>(1) Heavy sweating during hot work; (2) Drinking large volumes of water without replacing salt loss</p>	<p>Loss of body salt in sweat, water intake dilutes electrolytes, water enters muscles, causing spasm</p>	<p>Salted liquids by mouth, or more prompt relief by I-V infusion</p>	<p>Adequate salt intake with meals; in unacclimatized workers supplement salt intake at meals</p>

4. Skin Eruptions				
(a) Heat Rash (miliaria rubra; “prickly heat”) Profuse tiny raised red vesicles (blister-like) on affected areas prickling sensations during heat exposure	Unrelieved exposure to humid heat with skin continuously wet with unevaporated sweat	Plugging of sweat gland ducts with retention of sweat and inflammatory reaction	Mild drying lotions, skin cleanliness to prevent infection	Cool sleeping quarters to allow skin to dry between heat exposures
(b) Anhidrotic Heat Exhaustion (miliaria profunda) Extensive areas of skin which do not sweat on heat exposure, but present gooseflesh appearance, which subsides with cool environments; associated with incapacitation in heat	Weeks or months of constant exposure to climatic heat with previous history of extensive heat rash and sunburn	Skin trauma (heat rash; sunburn) causes sweat retention deep in skin, reduced evaporative cooling causes heat intolerance	No effective treatment available for anhidrotic areas of skin, recovery of sweating occurs gradually on return to cooler climate	Treat heat rash and avoid further skin trauma by sunburn, periodic relief from sustained heat
5. Behavioral Disorders				
(a) Head Fatigue — Transient Impaired performance of skilled sensorimotor, mental, or vigilance tasks, in heat	Performance decrement greater in unacclimatized and unskilled worker	Discomfort and physiologic strain	Not indicated unless accompanied by other heat illness	Acclimatization and training for work in the heat
(b) Heat Fatigue — Chronic Reduced performance capacity, lowering of self-imposed standards of social behavior (e.g., alcoholic over-indulgence), inability to concentrate, etc.	Workers at risk come from temperate climates, for long residence in tropical latitudes	Psychosocial stresses probably as important as heat stress, may involve hormonal imbalance but no positive evidence	Medical treatment for serious cases, speedy relief of symptoms on returning home	Orientation on life in hot regions (customs, climate, living condition, etc.)

From *Criteria for a Recommended Standard: Occupational Exposure to Hot Environments*, revised criteria, NIOSH publication No. 86-113, 1986.

- a. Gradual increase of sweating. A heat acclimatized worker can lose up to 2 liters of sweat per hour, and up to 6 liters of sweat per workday.
- b. The sweat becomes more dilute, i.e., presents a lower salt concentration. This change helps to prevent heat disorders such as heat cramps.
- c. Gradual reduction of body weight. This reduction allows a more efficient heat exchange with the environment due to reduced fat, and reduces energy consumption.
- d. Gradual reduction of heart rate and body temperature.

Both exposure to the heat and physical activity are necessary for acclimatization to take place. In general, exposure to the hot job for approximately two hours per day will result in complete acclimatization in a period of two to three weeks. Exposure to the job for more than two hours a day will speed up acclimatization somewhat. Termination of exposure to the heat stress will result in lost acclimatization in a period of 2 to 3 months. However, a significant loss of acclimatization takes place in the first week of this period. Thus, workers who have been removed from the hot job for a period of one week or more (say, for a vacation), and return to that job, will need to get acclimatized again. Much of the work on heat acclimatization has come from the need to rapidly acclimatize a changing work force in deep mining. Hence, some account must be taken of the work which the individual is expected to perform in the acclimatized state.

There is one final stage to this process of adaptive change which occurs at a genetic level whereby those best able to combat the adverse effects of heat exposure are subject to forms of selection which promote certain bodily traits. These can be seen in the peoples of the world as they have adapted to differing geographical and climatological conditions. However, since this is not a part of worker acclimatization in the manipulable sense, we do not dwell on this aspect of adaptation.

Measurement of Heat Stress

The four environmental variables that affect the sensation of comfort and the heat exchange process with the environment are: air temperature, relative humidity, air velocity, and temperature of the surrounding surfaces. Those variables, combined with the amount of physical work performed by an individual, and the amount of clothing worn, largely define the thermal environment. In the past 50 years, various indices have been developed to assess or predict the level of environmental heat stress. Some of these indices take into consideration only a single environmental factor, whereas others combine the effects of all four environmental variables directly or indirectly. Finally, the level of metabolic heat production is not considered, with the exception of heat stress index (HSI). In considering a number of these heat stress indices, we indicate how measures of the four components of the thermal environment are typically measured.

1. *Dry bulb temperature.* The dry bulb temperature is the simplest practical index of cold and warmth under usual room conditions. It is measured with a dry bulb thermometer, such as an ordinary mercury-in-glass thermometer and is significant in judging comfort under cold conditions.

2. *Wet bulb temperature.* The psychometric wet bulb temperature is a useful index of severe heat stress, especially when the body is near its upper limits of temperature regulation by sweating. It is obtained by drawing air at a velocity of at least 1000 feet per minute over a wetted wick covering a mercury-in-glass thermometer effectively shielded from radiation. The natural wet bulb temperature is obtained when the wetted wick covering a mercury-in-glass thermometer is exposed to natural air movement unshielded from radiation.

3. *Black globe temperature.* The equilibrium temperature of a black globe has been used as a single temperature index describing the combined physical effect of the dry bulb temperature, air movement, and radiant heat received from surrounding conditions. The black globe temperature is measured with the globe thermometer. It consists of a 6-in. diameter thin copper sphere, the outside of which is painted matte black. A mercury-in-glass thermometer, having a range of 30°F to 220°F with 1°F graduation and accurate to 1°F is inserted through a rubber stopper in a hole in the top of the shell, and the thermometer bulb is located at the center of the globe.

These first three indices represent values derived directly from physical instruments used to assess particular parts of the thermal environment. However, there are several indices which derive their values from various combinations of these measures. One of the first of these is the effective temperature (ET) index derived by Houghten and Yaglou (1923).

4. *Effective Temperature (ET)*. ET has been one of the best known and most widely used of all thermal indices. It combines into a single value the effects of air temperature, humidity, and air movement on the body. According to this index, different combinations of these values which provide the same perceived level of warmth are given the same value of effective temperature. In cases where radiant heat is present and the person is fully clad, the corrected effective temperature (CET) may be used instead. CET substitutes black globe temperature for the dry bulb temperature of the original effective temperature scale to correct for effects of any intense radiant heat source in the surrounding environment, such as the opening to a blast furnace.

5. *Wet Globe Temperature (WGT)*. The wet globe temperature index was developed by Botsford (1971). Only one temperature is required to determine this index. A thermometer is placed in the center of a hollow 2.5-in. diameter black globe covered with a wetted black cloth. When placed in the hot environment, an equilibrium is obtained between evaporative cooling, convective heating, and radiant heating. The equilibrium temperature measured after approximately 15 minutes is the wet globe temperature.

6. *Heat Stress Index (HSI)*. The rationale behind the heat stress index proposed by Belding and Hatch (1955) is the concept that in order to maintain body temperature within the safe range, the body's heat loss must equal or exceed heat gain. Their heat stress index is the ratio of the body's heat load from metabolism, convection, and radiation E_{req} to the evaporative cooling capacity of the environment E_{max} . By multiplying this ratio by 100, the HSI index is obtained. This can be expressed in equation form as follows:

$$HSI = E_{req} / E_{max} = 100 (M + C + R) E_{max}$$

where M = the heat from metabolism, C = the heat gain or loss from convection, and R = the heat gain or loss from radiation.

7. *Wet Bulb Globe Temperature (WBGT)*. Yaglou and Minard (1957) developed the wet bulb globe temperature (WBGT) index in order to take into consideration radiant heat and air velocity. Originally, it was based on the psychrometric wet bulb temperature t_{wb} and the black globe temperature t_g as follows:

$$WBGT = 0.7 t_{wb} + 0.3 t_g$$

Subsequently, the t_{wb} was replaced by the natural wet bulb temperature t_{nwb} , so today WBGT is a function of t_{nwb} , t_g , and for outdoors the dry bulb temperature t_{db} . The weighting of these temperatures is expressed according to the following formulas:

For indoor conditions

$$WBGT = 0.7 t_{nwb} + 0.3 t_g$$

and for outdoor conditions

$$WBGT = 0.7 t_{nwb} + 0.2 t_g + 0.1 t_{db}$$

The natural wet bulb temperature is measured by a mercury-in-glass thermometer having a range of 30°F to 120°F with 0.5°F graduations and accurate to 0.5°F. An absorbent cotton wick is used to cover the thermometer bulb at least 1.25 inches above the bulb. The lower end of the wick is immersed in a reservoir of distilled water at the temperature of the work area, and there is about 1 inch of wetted wick exposed to the air between the top of the reservoir and the bottom of the thermometer bulb. The wick

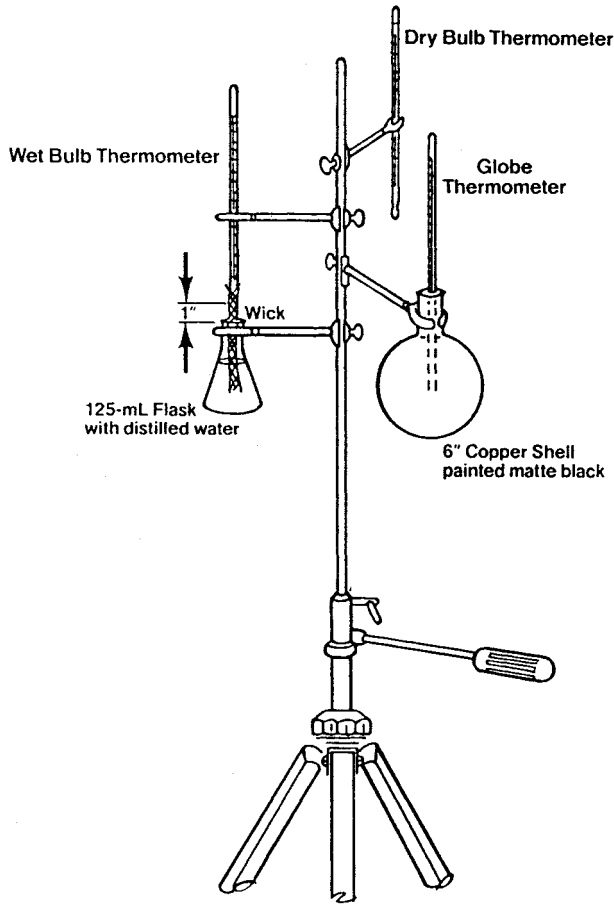

FIGURE 18.2 Instrument arrangement for outdoors WBGT measurements. (From *Fundamentals of Industrial Hygiene*, National Safety Council, 3rd edition, 1988, p. 269.)

must be wet at all times in order to obtain accurate readings. Figure 18.2 shows an instrument arrangement that can be used to obtain measurements of the various outdoor temperatures. Today, several portable instruments are available to measure the WBGT index.

Metabolic Heat Measurement

Metabolic heat production is combined with the effect of the environmental factors, and adds to the level of heat stress imposed on the worker. Thus, it is necessary to know the metabolic energy expended during routine physical activities. Table 18.2 provides estimates of energy metabolism of various types of activities for light, moderate, and heavy work. In cases where the worker is engaged in various types of activities over the 8-hour shift, a time-weighted average (TWA) energy expenditure for these activities should be calculated.

Physiological Exposure Limits to Heat Stress

From the physiological standpoint, it is generally agreed that exposure to occupational heat stress should be terminated when the rectal temperature reaches the upper limit of 38°C (Dukes-Dobos, 1976; Fanger, 1972). Grandjean (1988) proposed upper temperature limits for daytime work, which are reproduced in

TABLE 18.2 Energy Metabolism Values for Various Activities

Activity	Metabolic Rate, M				
	Btu/hr	Watts (W)	kcal/hr	kcal/min	
Sleeping	250	73	63	1.05	
Sitting quietly	400	117	100	1.75	
Light Work	Sitting, moderate arm and trunk movements (e.g., desk work, typing)	450–550	130–160	113–140	1.8–2.3
	Sitting, moderate arm and leg movements (e.g., playing organ, driving car in traffic)	550–650	160–190	140–160	2.3–2.7
	Standing, light work at machine or bench, mostly arms	550–650	160–190	140–160	2.3–2.7
Moderate Work	Sitting, heavy arm and leg movement	650–800	190–235	165–200	2.8–3.3
	Standing, light work at machine or bench, some walking about	650–750	190–220	165–190	2.8–3.2
	Standing, moderate work at machine or bench, some walking about	750–1,000	220–290	190–250	3.2–4.2
	Walking about, with moderate lifting or pushing	1,000–1,400	290–410	250–350	4.2–5.8
Heavy Work	Intermittent heavy lifting, pushing or pulling (e.g., pick and shovel work)	1,500–2,000	440–590	380–500	6.3–8.3
	Hardest sustained work	2,000–2,400	590–700	500–600	8.3–10.0

Note: Values apply for a 70-kg (154 lb) man, and do not include rest pauses.
 From *Fundamentals of Industrial Hygiene*, National Safety Council, 3rd edition, 1988, p. 272.

TABLE 18.3 Temperature Limits for Daytime Work in Hot Environments

Overall Consumption of Energy (KJ/h)	Examples	Upper limit of temperature (°C)	
		Effective Temperature	Temp. with 50% RH
1600	Heavy work; walking, with 30 kg load	26–28	30.5–33
1000	Moderately heavy work; walking at 4 km/h	29–31	34–37
400	Light sedentary work	33–35	40–44

From Grandjean, E. 1988. *Fitting the Task to the Man*. 4th Edition. Taylor and Francis: New York.

TABLE 18.4 Permissible Working Times for Heavy Work

Wet-Bulb Temperature (°C) ^a	Permissible Working Time (min)
30	140
32	90
34	65
36	50
38	39
40	30
42	22

From Grandjean, E. 1988. *Fitting the Task to the Man*. 4th Edition. Taylor and Francis: New York.

Table 18.3. If the heat load, i.e., consumption greater than 1900 kJ/hr, exceeds the values of Table 18.3, and cannot be reduced by technical means, Grandjean suggests shortening the working time according to Table 18.4.

In general, the upper physiological limits that should not be exceeded in hot industrial places can be expressed in terms of the physiological parameters heart rate, rectal temperature, and sweat evaporation as follows (Grandjean, 1988):

Heart rate:	100–110 beats/min (daily average)
Rectal temperature:	38°C
Evaporation of sweat:	0.6 l/h.

NIOSH (1986) has recommended alert limits (RALs) for the average, unacclimatized individual and exposure limits (REs) for the acclimatized individual in terms of WBGT as a function of work activity and hourly exposure to the heat. These limits apply to a standard worker of 70 kg (154 lb) body weight and 1.8 m² (19.4 ft²) body surface area. These curves are illustrated in a subsequent section in which we address the rationale for a greater use of behavioral indicators. In hot workplaces where meeting these limits is a problem, a variety of engineering and administrative controls can be implemented. These controls are listed in Table 18.5.

TABLE 18.5 Engineering and Administrative Controls Recommended for Control of Heat Stress

Engineering Controls
<ul style="list-style-type: none"> • Install air conditioner in the workplace. • If air temperature is below 35°C, increase cooling by enhanced general or local ventilation by means of fans and blowers. • Install line-of-sight radiant reflective shields around radiant heat sources. • Where possible, apply coating to the radiant heat source to reduce its emissivity. • Where possible, eliminate water-vapor sources in the workplace. • Automate or mechanize physical components of work to reduce physical activity demands. • Provide heat-protective clothing (goggles, heat reflective garments, etc.) where necessary. • Train workers on how to wear such clothing.
Administrative Controls
<ul style="list-style-type: none"> • Schedule hot activities during the cooler parts of the day. • Schedule routine maintenance and repair activities in hot spots in the cooler seasons of the year. • Increase personnel to reduce heat stress exposure time per worker. • Make water or other fluids readily available to hot workplaces. • Encourage frequent water intake in hot industrial workplaces. Water should be taken at least once every hour. • Implement a heat-acclimatization program by gradually exposing the worker to the hot job. Heat acclimatization can be induced in 5 to 7 days of exposure to the hot work environment. A few variations of heat acclimatization programs have been proposed. According to the National Safety Council, for workers with previous experience with the job, acclimatization is induced using the following schedule of exposure: 50% on day one, 60% on day two, 80% on day three, and 100% on day four. For workers without previous experience with the job, the exposure should be 20% on day one with 20% increase on each additional day. • Encourage workers to participate in physical fitness programs. • For heat unacclimatized workers on a restricted salt diet, additional salt intake during the first 2 days of exposure to the hot job may be required; the worker's physician, however, should be consulted. • Implement a heat stress training program in the workplace. Such a program should teach supervisors and workers on recognizing early signs and symptoms of heat-induced illnesses, and administration of first-aid procedures. • Implement a buddy system; under such a system, supervisors and workers trained in recognizing heat-induced signs and in providing first-aid procedures are assigned the task of periodically observing fellow workers for early signs of heat illnesses. When such signs are present, the worker should not be allowed to continue work, and should be sent to the first-aid station for a more thorough evaluation. • Screen worker medical records for heat intolerance. Workers who have experienced heat illnesses in the past are likely to be less tolerant to heat stress.

(For comparisons see: Millican, Baker, and Cook, 1981).

In this section, we have briefly examined the basis for the physiological limits for heat stress exposure. It is not our main purpose here to provide an elaborate evaluation of these concerns, especially since there are many sources of information which provide further detailed coverage. (See, for example, ACGIH, 1986; Hardy, Gagge, and Stolwijk, 1970; ISO, 1989; Kantowitz and Sorokin, 1983; Kerslake, 1972; Konz, 1983; McIntyre, 1980; NIOSH, 1972; 1986; Parsons, 1993; Ramsey and Kwon, 1992; Rohles and Konz, 1987; Sanders and McCormick, 1987.) What we seek to establish is the importance of behavioral indices as indicators of the stress effects of heat and potentially the whole spectrum of occupational sources of stress. In claiming this ubiquity and the central importance of this approach, it is important to provide a full foundation for this claim, and this we do in the following sections.

18.3 The Prevalence of Heat Stress

In their publication, the National Institute for Occupational Safety and Health (NIOSH) estimated that, as a conservative figure, some five to ten million workers in United States may be exposed to heat stress as a potential safety and health hazard (NIOSH 1986). From geographical considerations alone, this figure is liable to be by population proportion, higher for workers on a worldwide scale, particularly given the predominance of agrarian economies in equatorial and tropical regions. In order to alleviate potential harm from heat stress and to protect exposed workers, as we have discussed above, a number of exposure criteria have been promulgated (see Parsons, 1995). In general, their principal aim is to provide guidelines for acceptable exposure to heat through designation of environmental conditions, exposure duration, work composition, and some rudimentary information concerning the status of the individual worker. NIOSH (1986) has more recently issued a revision of these criteria. Examination of this latter document highlights the careful and thorough evaluation of the physiological consequences of exposure to heat, and the derivation of criteria designed to protect the worker engaged in heavy physical labor from heat stress related illnesses such as heat stroke, heat syncope, heat exhaustion, and other disabling conditions as we have noted. In this respect, the revised criteria admirably attain this aim. Such protection guards workers engaged in traditional industrial activities which are composed primarily of differing degrees of physical activity.

However, the revised criteria neglect a large and growing segment of the industrial population whose job is to perform more cognitively demanding operations frequently within the confines of complex operational systems. It is also the case that numerous workers have to combine different duties, where for one period they may be actively engaged in exacting physical labor, and the next moment, monitoring automated systems for critical failures. The deletion of cognitive performance limits under heat stress in the NIOSH (1986) document was intentional (Ramsey, 1995). It was suggested (NIOSH, 1980) that an insufficiently clear picture had been developed concerning such a relationship. We suggest a resolution is now possible. Consequently, one particular purpose of the present work is to explore heat stress exposure limits not founded upon the concept of physiological injury or medical illness, but predicated upon performance change. As the growth of cognitive, information-processing work characteristics is ubiquitous throughout contemporary industry, the necessity to consider behavior-related exposure limits applies across the wide spectrum of occupational stress sources and is not restricted to heat stress alone. The generality of this important observation is explored in the final section of the chapter.

18.4 The Foundation for Exposure Criteria to Occupational Stress

As indicated by Millar (1986), the revised heat stress criteria (NIOSH, 1986) were generated as part of programmatic efforts initiated by the Occupational Safety and Health Act (U.S. Public Law 91-596, 1970). Documents were designed to:

...provide *medical* criteria which will assure insofar as practicable that no worker will suffer diminished *health, functional capacity, or life expectancy* as a result of his (or her) work experience. (Italics and parenthetical inclusion added.)

Following the wording of the above designation, current exposure limits for occupational stress are founded upon medical evaluations of the impact of components of the ambient surroundings upon physiological functioning. This natural line of development emanates from the fact that traditional concern for worker safety and health is founded in, and focused through the medical profession, whose knowledge of physiological systems and the disturbances to which they are vulnerable is preeminent. Consequently, evolving criteria limits have been based upon the premise of avoidance of acute or chronic physiological insult to the whole organism or component sensitive organs. Such sentiments are to be applauded and our purpose here is not to disparage this approach in any way. Rather, it is to extend this protective rationale by providing a more sensitive tool for the use of practitioners. That is, the assessment of behavioral efficiency.

Development of performance-based criteria is neurobiologically justified since the central nervous system displays particular sensitivity to disturbance due to stress, and its behavioral manifestation in performance capability represents an avenue through which to evaluate early and less obvious effects due to occupational stress compared with traditional gross physiological manifestations. From the managerial and safety standpoint such an approach has at least two useful facets. First, productivity, as generated by performance, is a prime concern of management and such data are constantly under scrutiny. Second, with the changing nature of work, the failure of cognitive decision-making activities and operator error are becoming of greater concern as the concentration upon heavy physical work wanes.

As medical criteria, the NIOSH (1986) recommendations are conservative and justified. However, the criteria also seek to:

Protect against the risk of heat-induced illness and unsafe acts. ...prevent possible harmful effects from interactions between heat and toxic, chemical, and physical agents.

However, it is commonly the case that efficient performance on a task fails before physiological limitations are reached or physiological systems are perturbed to the boundaries of their region of steady-state operation. Consequently, if the workers are no longer able to adequately discharge their duties by performing the task in question in the stressful condition, why is continued exposure permitted?

This latter statement explicitly recognizes limitations to safe functioning as given in the criteria aims cited above. To elaborate with an example, if a worker is required to monitor a display for a critical signal to initiate an important response (cf., Hancock, 1984), is it advisable to continue exposure (within physiological limits) if that worker is missing a significant and potentially catastrophic number of signals for response? The submission here is that, although insufficient to cause physiological distress, such conditions cause unacceptable hazard to the worker, his or her colleagues, and the system within which they are operating. We suggest that, as performance is commonly the most sensitive systemic response to imposed environmental stress, and is the key reason for exposing the worker to many occupational sources of stress in the first place, exposure guidelines should be formulated to deal with such restrictions in appropriate work conditions. It is the lack of information upon those forms of performance variation that represents one major limit of the current heat stress criteria document revision (see NIOSH 1986, p. 32).

18.5 Current Criteria: Derivations and Limitations

The first criteria developed by NIOSH (1972) did give recommended limits for a threshold of unimpaired mental performance. This illustration is produced in Figure 18.3. This curve was a simple transcription of that described by Wing (1965) from his review of then existing studies. Having examined the extrapolations and inferences Wing made from a survey of existing studies, Hancock (1981) re-evaluated this threshold and provided a revision of these tolerance limits based on correction of factual errors and suspect interpretations. This comparison was incorporated into a number of texts. For example, Kantowitz and Sorkin (1983) observed that:

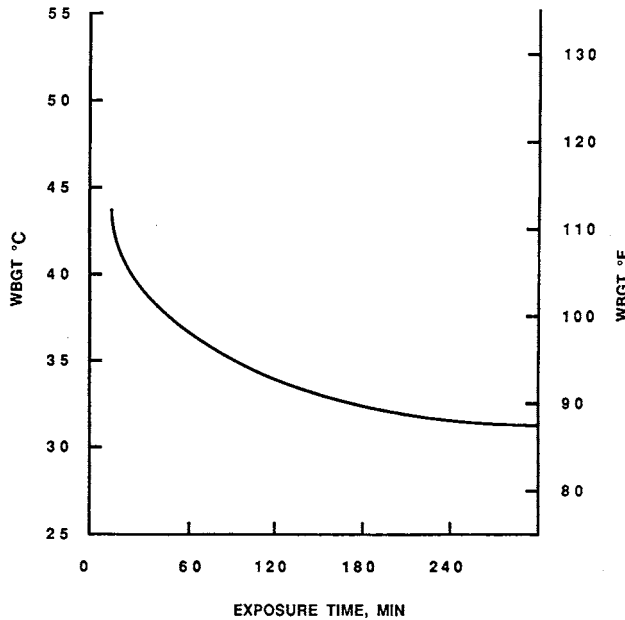

FIGURE 18.3 Upper limits of exposure for unimpaired mental performance. (From National Institute for Occupational Safety and Health [NIOSH] 1972, *Criteria for a Recommended Standard-Occupational Exposure to Hot Environments* [NIOSH Publication No. 72-10269].)

There is currently strong disagreement about the effects of heat stress on the mental efficiency of sedentary workers. Wing (1965) performed the classic study of this problem. Wing found that mental tasks such as arithmetic and memory tasks were not affected for very short exposures (6 minutes) but that exposures of about 43 minutes to effective temperatures over 100°F did cause impairment. Wing proposed an exponential function relating exposure time, and an effective temperature (see Figure 19-6) later adopted by the National Institute for Occupational Safety and Health (NIOSH, 1972) as the recommended standard for the lower limit of heat-impaired mental performance. These limits are reached before the physiological tolerance limit of the human. However, this standard has been strongly criticized as being far too conservative (Hancock, 1980). A detailed reanalysis of Wing's data has led to the line in Figure 19-6 labeled Hancock. It is close to the physiological limits, shown as the line labeled Taylor in Figure 19-6. Until this debate is resolved, cautious Human Factors Specialists will base decisions on a curve falling between the Hancock and the Wing stress tolerance functions; extremely cautious designers may prefer to use the more conservative Wing tolerance curve.

In his work on a wide variety of stress effects, Hockey (1986) commented:

Wing (1965) summarized the results of 15 studies of performance on sedentary tasks. These data have become the basis of a well-known guideline for heat limits in Industry (NIOSH, 1972), illustrated in Figure 44.7. The limit of unimpaired performance at any combination of temperature and duration is well below that for physiological tolerance. A recent reevaluation of this evidence (Hancock, 1981) suggests that the upper limit is very close to that for physiological collapse. This conclusion is based on a detailed analysis of only one study (Blockley and Lyman, 1951), however, and may not be representative of the effects of thermal stress on performance.

Finally, Sanders and McCormick (1987) observed:

Note that Wing (1965) had developed a curve of tolerance limits for performing mental activities similar to the curve for mental and cognitive tasks shown in Figure 15-9. However, Wing's curve was somewhat lower than Hancock's — actually a bit below the curve for tracking tasks. In discussing this

difference Hancock argues that, on the basis of his synthesis, mental and cognitive abilities can be performed at a level closer to the physiological limits than is reflected by Wing's presentation. The clarification of such a difference, however, probably is still dangling.

The graphs described by Hockey (1986), by Kantowitz and Sorkin (1983) and Sanders and McCormick (1987) are reproduced in Figures 18.4 and 18.5.

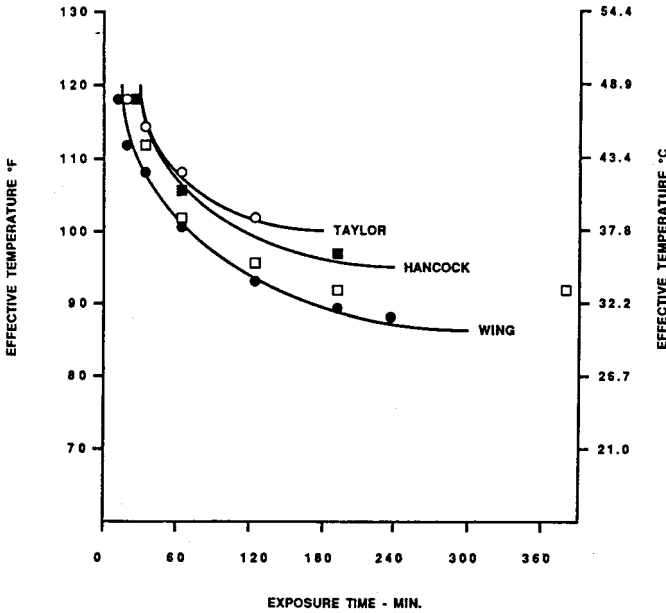

FIGURE 18.4 Revised heat stress limits of exposure for unimpaired mental performance (Hancock curve). The Taylor curve indicates physiological tolerance to heat stress (Taylor, 1948), and the Wing curve represents the exposure limits adopted by NIOSH, 1972 (see Figure 18.3).

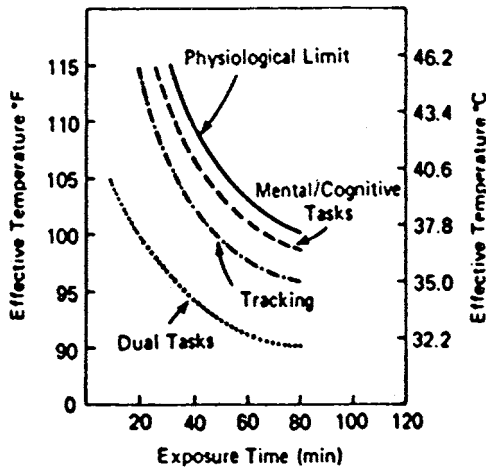

FIGURE 18.5 Revised heat stress limits of exposure for unimpaired mental performance. (From Sanders, M.S. and McCormick, E.J. 1987. *Human Factors in Engineering and Design*, 6th Edn, McGraw-Hill, New York. With permission.)

It is important to address the issues raised by these commentators, as their summaries are often the first, and on occasion the only source of information available to individuals who are concerned with broad interdisciplinary inquiries as typified in ergonomics and human factors. The observations made by Kantowitz and Sorkin (1983) are factually correct, although one inference they make might be regarded as slightly misleading. In the original work, Hancock (1980) criticized the factual basis for the foundation of Wing's curve. However, the use of the two respective curves and their functions as protective standards was not considered exhaustively in the latter work since the focus was on tolerance itself, not on recommended limits. One obvious drawback in the use of Wing's curve is that NIOSH (1972) simply transcribed Wing's original curve for their use, and in so doing apparently equated effective temperature and WBGT, which is a highly questionable procedure. However, this does not mean that either Wing (1965) or Hancock (1980) expressly advocated their respective curves as tolerance criteria. Rather, they are the limits at which significant impairment in mental performance can be expected. As pointed out above, operating at ceiling limits as a protective standard is a highly inadvisable strategy. Clearly, it is appropriate in setting tolerance criteria to adopt conservative standards. As Konz (1983) and others have pointed out, information from studies which underlie such criteria are often taken from well motivated, young college subjects, who are exposed on only one or two occasions to the debilitating effects of the stress. However, the subsequent protection is often directed toward older individuals who experience the potential for chronic as well as acute exposures and whose motivation to perform cannot be sustained at the same level for extended periods of operation. Compounded with these are additional concerns such as gender, fitness, task performance capability and numerous other individual differences that have to be understood before a fully comprehensive standard can be finalized (see also Enander and Hygge, 1990). As pointed out by Hancock (1980) then, the standard was rightly conservative, but for essentially the wrong reason, being founded on fallacious information. This is more than mere polemics in that subsequent differentiation of tasks (Hancock 1982, 1984) indicated that some forms of performance could be expected to suffer impairment at time/intensity combinations well below those designated by Wing's curve.

Hockey's (1986) comments indicated misapprehension by suggesting that the re-evaluation by Hancock (1981) was based on only a single study, that being the report by Blockley and Lyman (1951). As perusal of the original work shows, the re-evaluation was actually based upon the analysis of all the studies cited by Wing (1965), and a number of reports that appeared since that time. It is the case that one clear factual mistake made by Wing (1965) was in his interpretation of the data given by Blockley and Lyman (1950) (not Blockley and Lyman, 1951, as indicated by Hockey, 1986), an observation that certainly was given prominence by Hancock (1981). However, Wing's interpretation of Blockley and Lyman's (1950) data was an important point in that it established a critical exposure at the one-hour duration. It is not correct to assert that Hancock's (1981) whole argument was based on the results from this single study.

Sanders and McCormick (1987) pointed to the problem of task differentiation. They noted that the curves subsequently developed by Hancock (1982), and discussed in more detail below, crossed the single function given by Wing. It is important to note that in his work, Wing did not make any explicit differentiation for task performance category. In so doing he implied the equivalence between tasks that require simple mental operations (e.g., mental arithmetic as reported by Blockley and Lyman, 1950) and those involving some more complex motor responses (e.g., tracking as reported by Pepler, 1958). Hancock (1982) argued that such tasks could not be considered of homogeneous cognitive demand and had to be differentiated. This tactic had also previously been advocated by other researchers (e.g., Grether, 1973; Ramsey and Morrissey, 1978). When such a differentiation was made, the tolerance limit curves for each category of performance tasks showed common shapes, although occurring at different absolute tolerance levels; see Figure 18.5. This important observation becomes the subject of more critical evaluation later in the present work.

Each of the above reviews rightly indicated the danger of extrapolating thresholds from a sparse database, and in considering the different interpretations that can be made from each supportive study.

However, some of their respective equivocation does not sufficiently reflect the fact that Hancock (1980, 1981) pointed to a number of simple *factual* mistakes made by Wing (1965) in his original interpretation. Given some of these problems it is perhaps not surprising that the limits illustrated in Figure 18.4, as included in the first NIOSH criteria document, were not reproduced in the subsequent revised criteria (NIOSH 1986).

18.6 Single Versus Multiple Thresholds for Criteria

As is readily apparent from the above argument, one of the limitations to Wing's curve was the way in which all forms of performance tasks were included in the derivation of a single threshold, regardless of their actual composition. A different perspective on performance limits was given by Ramsey and Morrissey (1978). Following the notion developed by Grether (1973), they developed a description based on different task categories. Essentially, they distinguished two groups of tasks, one consisting principally of mental performance, and a second consisting of psychomotor performance. They rightly pointed out that for each respective group, a single delimiting curve could represent only the dichotomous differentiation into decrement and no decrement. Consequently, they developed isodecrement curves based upon the probability of performance failure at particular time-temperature conditions. Examples of such curves are given in Figures 18.6 and 18.7. As can be seen by comparing the respective figures, there are radically different limits depending on the nature of the task. In subsequent work, Hancock (1982) sought commonalities across these different limits as they applied to the respective tasks, particularly at the upper extremes of exposure. The illustration in Figure 18.8 shows the detailed foundation of this subsequent synthesis. As can be seen, each of the curves presents a similar shape, including the limits for physiological tolerance, and these accord with the limits presented by Meister (1976).

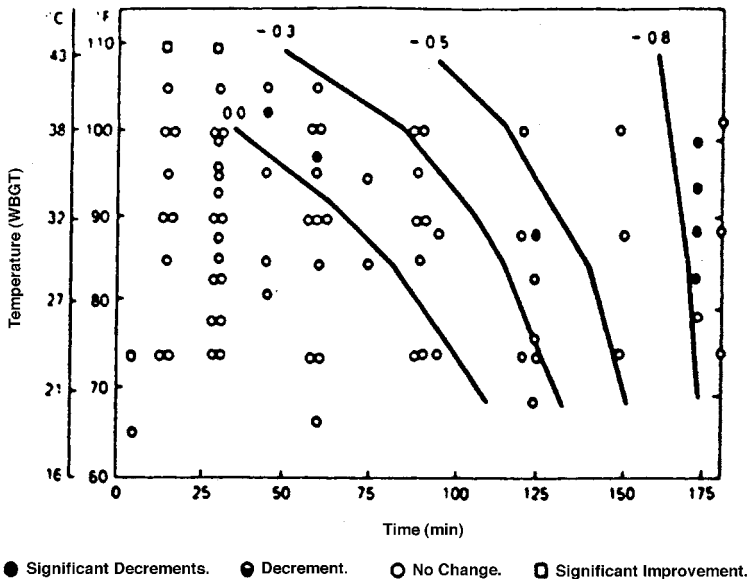

FIGURE 18.6 Isodecrement curves for mental performance tasks. The numbers represent level of performance decrement in the range from 0.0 (no change) to -1.0 (definite significant decrement in task performance). (From Ramsey, J.D. and Morrissey, S.J. 1978, Isodecrement curves for task performance in hot environments, *Applied Ergonomics*, 9, 66-72. With permission.)

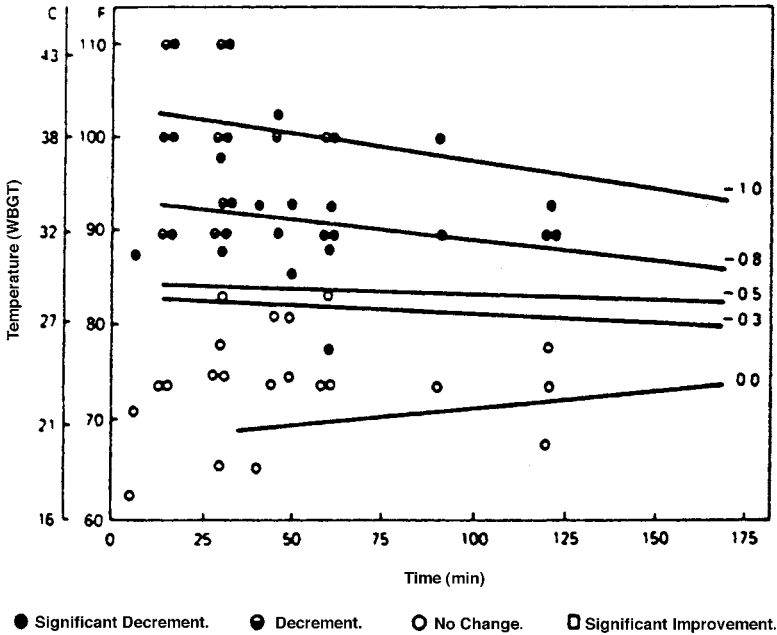

FIGURE 18.7 Isodecrement curves for tracking tasks. The numbers represent level of performance decrement in the range from 0.0 (no change) to -1.0 (definite significant decrement in task performance). (From Ramsey, J.D. and Morrissey, S.J. 1978, Isodecrement curves for task performance in hot environments, *Applied Ergonomics*, 9, 66-72. With permission.)

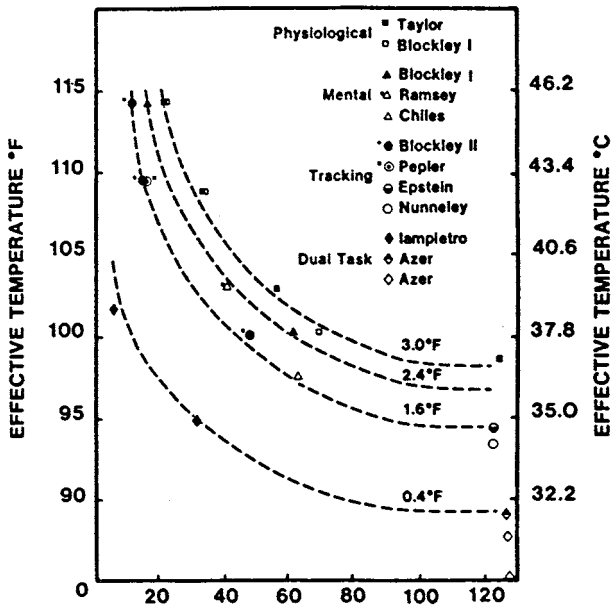

FIGURE 18.8 Heat stress limits for unimpaired performance for mental and cognitive tasks (triangular symbols), tracking tasks (circular symbols), and dual-tasks (diamond symbols). Square symbols represent physiological tolerance. Superimposed are dashed lines representative of prescribed rises in deep body temperature which accrue from time, ET intensity specifications outlined. These absolute values for the rise of body temperature are given on each curve. Names are for the first author for each study. (From Hancock, P.A. 1982, Task categorization and the limits of human performance in extreme heat, *Aviation, Space and Environmental Medicine*, 53, 778-784. With permission.)

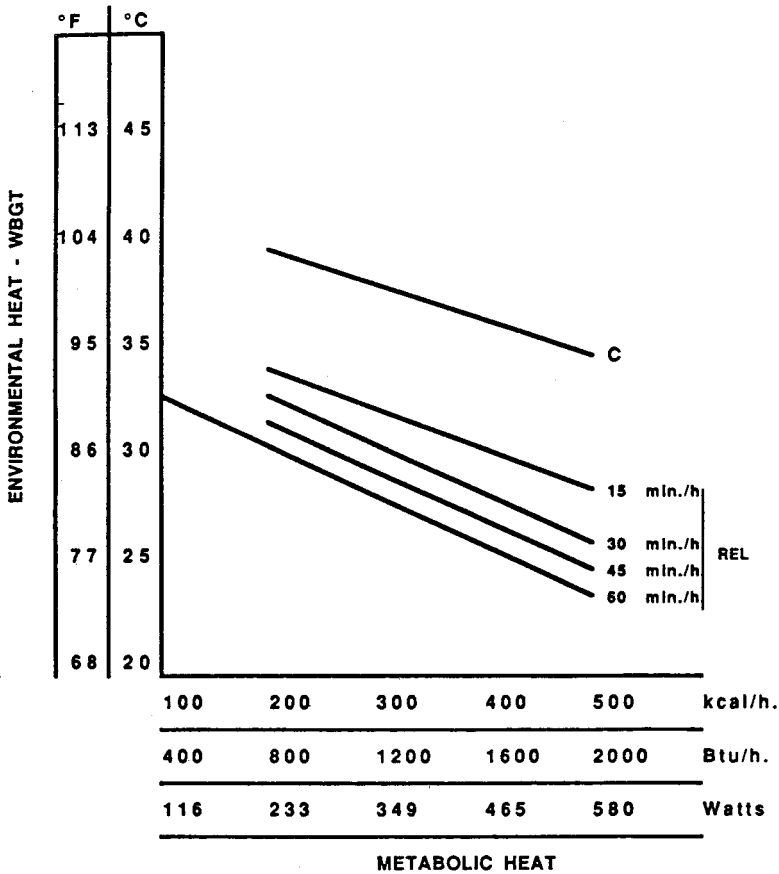

FIGURE 18.9 Revised heat stress limits (recommended exposure limits or REL) for acclimatized workers as a function of environmental heat (WBGT), intermitted work (min/h) and intensity of manual work as reflected by metabolic energy expenditure. The limits apply to a standard worker of 70 kg (154 lbs) body weight and 1.8 m² (19.4 ft²) body surface. (From National Institute for Occupational Safety and Health [NIOSH] 1986, *Criteria for a Recommended Standard: Occupational Exposure to Hot Environments* revised criteria [NIOSH Publication No. 86-113].)

Different limits based upon performance differentiation were quoted by Konz (1983) in his text on work design. He stated:

Wing and Touchstone made a 162-reference bibliography on the effects of temperature on human performance. Wing, summarizing 15 different studies of sedentary work in heat, gave Figure 20.4 as the temperature-time trade-off for mental performance; he noted that human performance deteriorates well before physiological limits have been reached. Hancock shows the effect on different tasks in Figure 20.5. Ramsey, Dayal and Ghahramani report their own data plus other support for Wing's curve.

Konz is correct in his statements, except that because the study reported by Ramsey, Dayal and Ghahramani was published in 1975 (Ramsey et al., 1975), they had no opportunity to comment on the relationship of their findings to the multiple curves published subsequently by Hancock (1982), but see Ramsey (1995).

The revised criteria (NIOSH 1986) give recommended alert limits and exposure limits from knowledge concerning the human physiological tolerance to heated conditions. Figures 18.9 and 18.10 present these thresholds for heat acclimatized and heat unacclimatized workers, respectively. They represent functions of an environmental heat load, expressed in WBGT units, and worker-generated heat load. Limits are given in terms of continuous and intermittent work schedules and between illustrations for differing

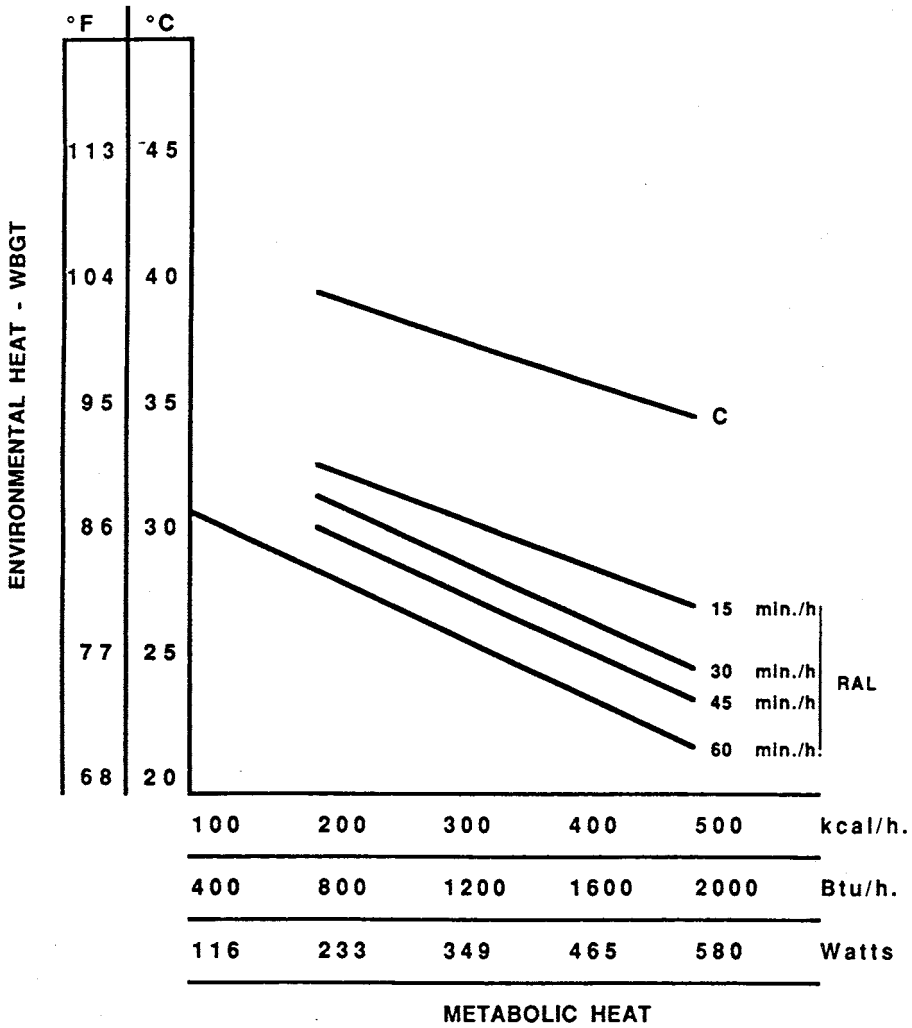

FIGURE 18.10 Revised heat stress limits (Recommended Alert Limits or RAL) for unacclimatized workers as a function of environmental heat (WBGT), intermitted work (min/h) and intensity of manual work as reflected by metabolic energy expenditure. The limits apply to a standard worker of 70 kg (154 lbs) body weight and 1.8 m² (19.4 ft²) body surface. (From National Institute for Occupational Safety and Health [NIOSH] 1986, *Criteria for a Recommended Standard: Occupational Exposure to Hot Environments* revised criteria [NIOSH Publication No. 86-113].)

states of worker acclimatization. However, as can be seen, these limiting functions make no reference to cognitively demanding work as did its predecessor.

In their article, Ramsey and Kwon (1992) examined results from more than 150 studies in which the impact of differing heat intensities and exposure times had been evaluated on differing forms of performance task. In keeping with their previous observations (Ramsey and Morrissey, 1978), they divided these tasks into two major categories, those requiring simple mental performance, and those requiring psychomotor response. Within these categories, they established whether the examined studies showed obvious and statistically significant decrement, marginal decrement, no evidence of performance change, or performance enhancement. No comparable marginal category was given for the case of enhanced efficiency. Of critical importance for these cross-study comparisons was the establishment of a common heat stress index which combines the characteristics of the thermal surround. As Ramsey and Kwon clearly pointed out, much of the experimental work in this area is two to three decades old, since contemporary human

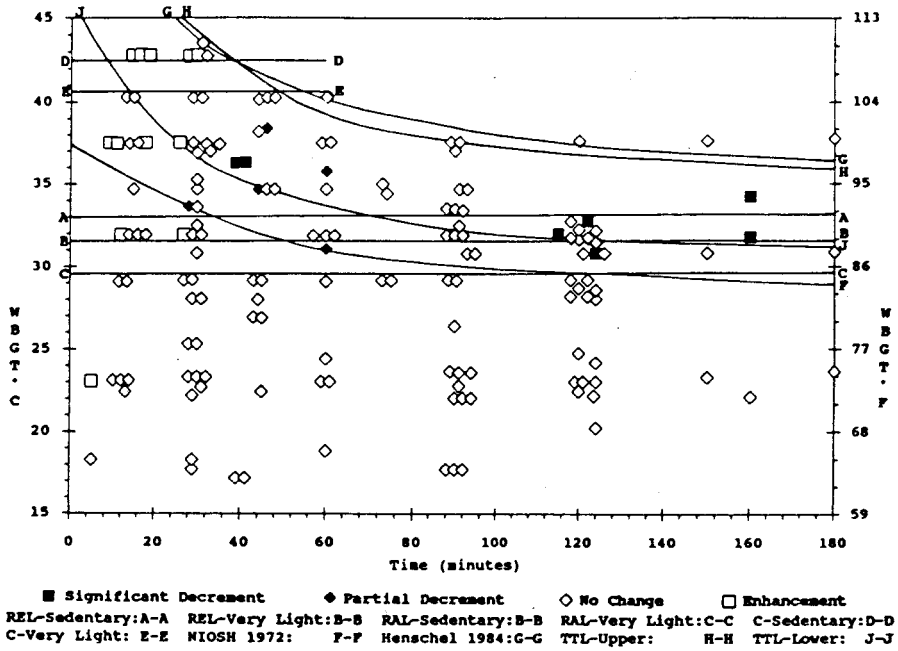

FIGURE 18.11 Mental or simple task performance in the heat and proposed temperature–time limits for human responses. REL, or recommended exposure limit, applies to heat acclimatized workers, and RAL, or recommended alert limit, applies to heat unacclimatized workers. Curves A-A, B-B, and C-C are exposure limits based on one-hour time-weighted averages for the case of unsteady thermal conditions. Curves D-D and E-E are the NIOSH 1986 recommended ceiling limits for sedentary and very light work, respectively. Curve G-G was derived based on personal communication between Ramsey and Kwon (1992) and Henschel. Curve H-H defines the upper thermal tolerance limits (TTL-Upper) for unimpaired neuromuscular performance as specified by Hancock and Vercruyssen (1988). Curve J-J (TTL-Lower) describes the time–temperature conditions where no change in deep body temperature is expected for the sedentary worker as specified by Hancock and Vercruyssen (1988). (Illustration from Ramsey, J.D. and Kwon, Y.G. 1992, Recommended alert limits for perceptual motor loss in hot environments, *International Journal of Industrial Ergonomics*, 9, 245-257. With permission.)

subject restrictions do not allow severe experimental heat exposures. As many early studies used the effective temperature (ET) scale, a perceptually oriented rather than an environmentally oriented scale, some assumptions and translations were needed to establish intensity levels on a common scale. Quite properly, Ramsey and Kwon chose the WBGT scale and used the NIOSH 1973 nomogram to convert ET to CET (or corrected effective temperature) units, from which WBGT values may be derived. This use of WBGT allows comparison with many current criteria documents (e.g., ISO 1982, NIOSH 1986, ACGIH 1988; see Parsons, 1995). Their findings are summarized in Figures 18.11 and 18.12.

Their findings indicate that for the category of very simple mental performance, there is little evidence of decrement across the range of intensities and exposure times surveyed and that on many occasions such capabilities are enhanced during brief exposures. These results confirm a previous assertion that there is only a slight mental performance decrement before impending physiological collapse (Hancock 1981, p. 180). However, as with Ramsey and Kwon's (1992) additional observations, it has been noted that most tasks which require constituents of motor performance are more susceptible to heat (Hancock 1981, p. 180). Hancock (1982) divided psychomotor performance on the basis of single and dual-task demands and found a number of consistencies in the data which are illustrated in Figure 18.8.

Following the careful division of the performance tasks and the establishment of curves whose functions were supported by experimental observations at specific conditions, Hancock (1982) used the function described by Houghten and Yagloglou (1923) to establish that the boundary functions of each

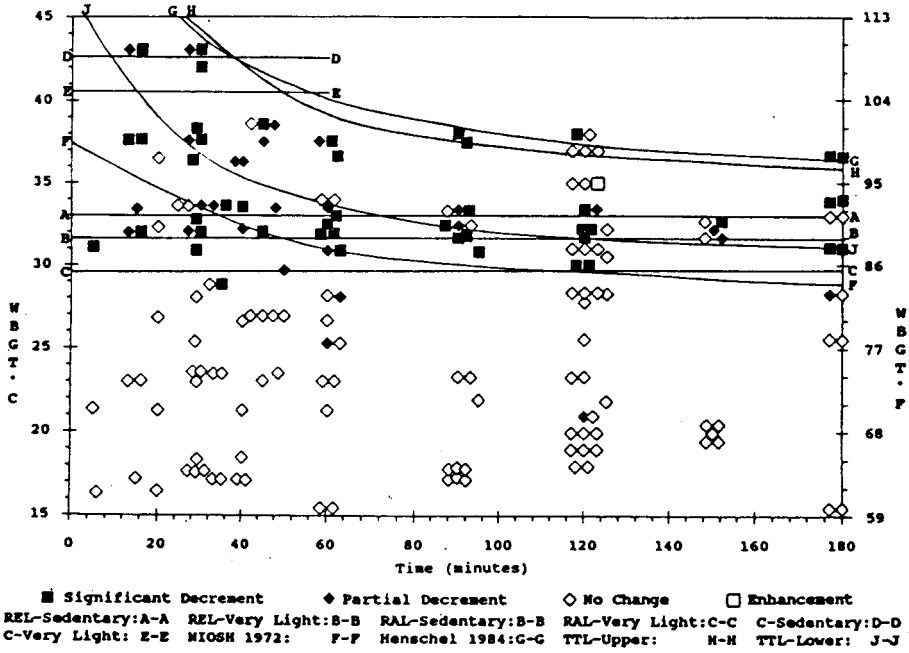

FIGURE 18.12 Perceptual motor task performance in the heat and proposed temperature–time limits for human responses. REL, or recommended exposure limit, applies to heat acclimatized workers, and RAL, or recommended alert limit, applies to heat unacclimatized workers. Curves A-A, B-B, and C-C are exposure limits based on one-hour time-weighted averages for the case of unsteady thermal conditions. Curves D-D and E-E are the NIOSH 1986 recommended ceiling limits for sedentary and very light work respectively. Curve G-G was derived based on personal communication between Ramsey and Kwon (1992) and Henschel. Curve H-H defines the upper thermal tolerance limits (TTL-Upper) for unimpaired neuromuscular performance as specified by Hancock and Vercruyssen (1988). Curve J-J (TTL-Lower) describes the time–temperature conditions where no change in deep body temperature is expected for the sedentary worker as specified by Hancock and Vercruyssen (1988). (Illustration from Ramsey, J.D. and Kwon, Y.G. 1992, Recommended alert limits for perceptual motor loss in hot environments, *International Journal of Industrial Ergonomics*, 9, 245-257. With permission.)

performance category are each represented by different dynamic changes to operator deep body temperature.¹ So, different levels of dynamic change to deep body temperature could be substituted for the distinct time/ET functions, illustrated as the limits for each task, and these values for each respective category were added to each boundary in Figure 18.8. A number of studies have used impermeable garments which manipulated dynamic change to deep body temperature, but without variation in environmental temperature, provided data that supported the observed limits of different deep body temperature values (Allan, Gibson, and Green, 1979). This convergent evidence established that it is *change* in the dynamic thermal state of the operator which influences performance, not manipulation of the physical environment *per se*. This is important when considering performance variations due to individual differences in capacities such as acclimatization and task skill (Enander and Hygge, 1990; Hancock, 1986a).

It is important to provide the rationale under which previous syntheses of empirical data relating heat stress to performance variation has been developed. In analogy with physical effort, Hancock (1982)

¹It should be noted that elevation to a higher steady state value, as occurs when the individual can use physiological mechanisms to partially neutralize the impact of the increased ambient thermal load, does not represent dynamic, or uncompensable change. So, it is the degree of change and its derivative, rate of change, that dictate dynamic oscillations in deep body temperature.

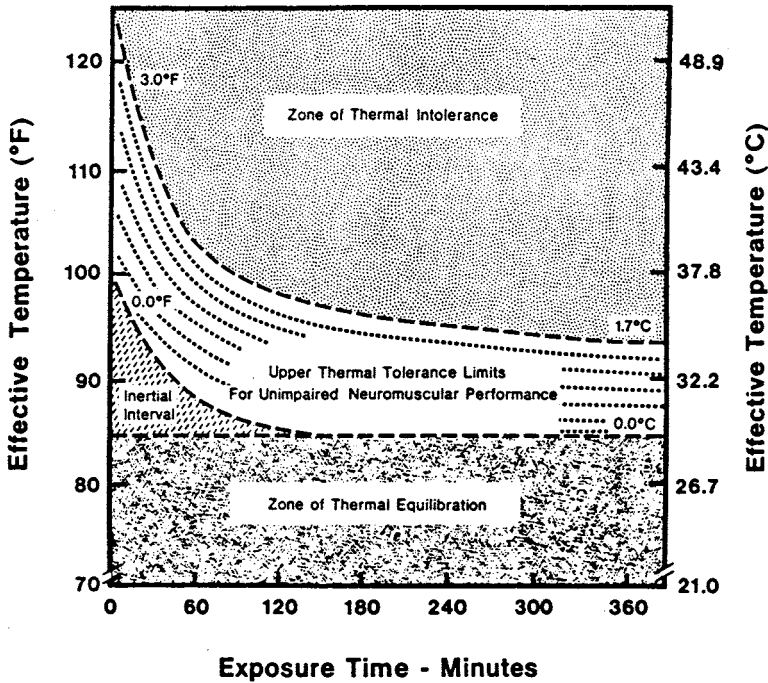

FIGURE 18.13 Differing performance zones identified by Hancock and Vercruyssen (1988). Numbers within the figure represent dynamic rise in deep body temperature.

suggested that the more demanding an information-processing task, the less heat strain could be sustained before performance interruption would occur. Therefore, as expressed in Figure 18.8, a task requiring considerable cognitive effort is constrained by a more conservative limit than one requiring comparatively little cognitive effort. Hancock (1982) indicated overall performance limits in a similar manner where simple mental tasks could be performed under conditions impermissible for a complex or dual task situation which required the simultaneous performance of two unrelated tasks. In this way, the attention demands of an information-processing task were equated with the physical demands of a material handling task. This is *not* to suggest that each may be directly related to metabolic demand as this implies an unfounded argument for an isomorphism between biochemical energy and information processing capacity (Hancock, 1986b). Further, in some tasks such as monitoring, very little effort is apparent but the hidden demands of such vigilance tasks make them particularly vulnerable to heat effects (Hancock, 1984, 1986b; Ramsey and Morrissey, 1978). As a result, Hancock (1982) plotted isodecrement curves for performance failure in heat which could be interpreted as limits, expressed also as dynamic change in deep body temperature. These were elaborated into descriptive zones of heat stress designation for the worker engaged in low metabolic demand activity (Hancock and Vercruyssen, 1988) (see Figure 18.13).

18.7 A New Descriptive Framework

There is, however, a more parsimonious way to describe human performance limits under heat stress. The approach is illustrated in Figures 18.14 and 18.15 and involves an alternative representation of known performance limit curves in different task categories. As shown in Figure 18.15, the characteristic of the primary (horizontal) axis is exposure time. The secondary (vertical) axis is thermal intensity of the environment expressed first in terms of the traditional effective temperature (ET). The temporal axis extends from the brief pulse-like exposures (approximately 3 minutes) to a time approximating a common shift, excluding meal breaks and start-up and shut-down time (approximately 7 hours). The vertical axis

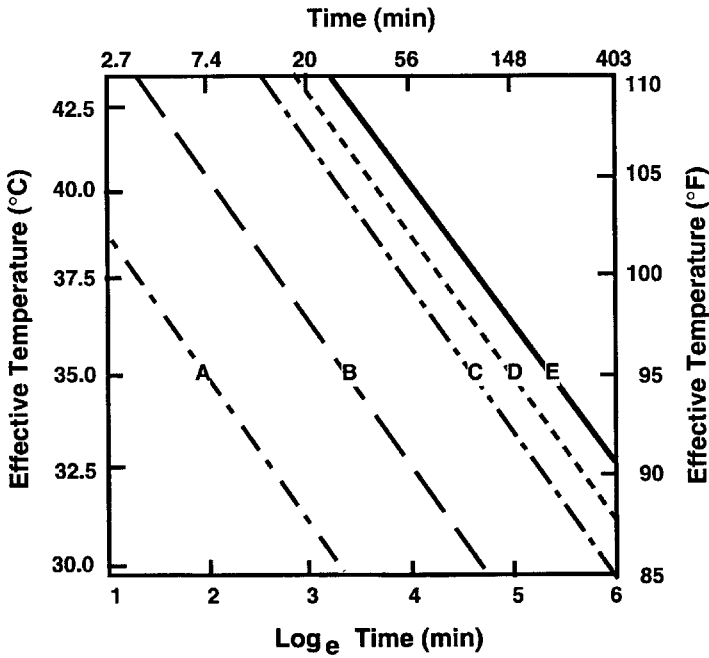

FIGURE 18.14 Human performance limits in $(ET)/\log_e(\text{Time})$ Cartesian space (A: vigilance performance, B: dual-task performance, C: tracking performance, D: simple mental performance, E: physiological tolerance). (From Hancock, P.A. and Vasmatazidis, I. 1998. Human occupational and performance limits under stress: The thermal environment as a prototypical example, *Ergonomics*, 44, 1169–1191. With permission of Taylor & Francis.)

extends from marginally tolerable conditions for any exposure period (i.e., 114°F ET) to the limits of Lind’s (1963) “prescriptive zone” (85°F ET). The prescriptive zone has more recently been termed the zone of thermal equilibration, to denote the absolute boundary of steady-state, thermoregulatory capacity (Hancock and Vercruyssen, 1988).

Within this framework, performance limit curves are plotted as parallel lines. The general form of the equation describing these performance thresholds is:

$$ET = a - b \log_e T \tag{1}$$

where ET is effective temperature, T is exposure time, and a and b are empirically determined constants. In the above relationship, parameter b, the slope of the equation, is equal to 4.094 and remains constant for each task category curve. Parameter a, the intercept of the lines with the thermal intensity axis, reflects the attentional involvement required by each task category plotted. The higher the value of parameter a, the higher the respective performance limit and the lesser the attentional demand placed on an individual by the task.

In Figure 18.14, performance limit curves are drawn from right to left in an increasing attentional demand order. Initially, to the right is line E indicating the physiological tolerance ceiling. Immediately below this absolute ceiling is the performance limit for simple mental tasks represented by line D (Hancock, 1981; Ramsey and Kwon, 1992), followed by tasks requiring neuromuscular coordination (line C). Next is line B, the threshold for dual-tasks combining each of the requirements in the two latter categories (Hancock, 1982). A final line (line A) formed from empirical data and using the summary as presented in Hancock (1986b), describes the tolerance of sustained attention, also known as vigilance, or more commonly in industry as monitoring and inspection (see also Hancock, 1984). Note that vigilance is particularly vulnerable to heat effects. This failure of monitoring-type behavior is particularly pertinent

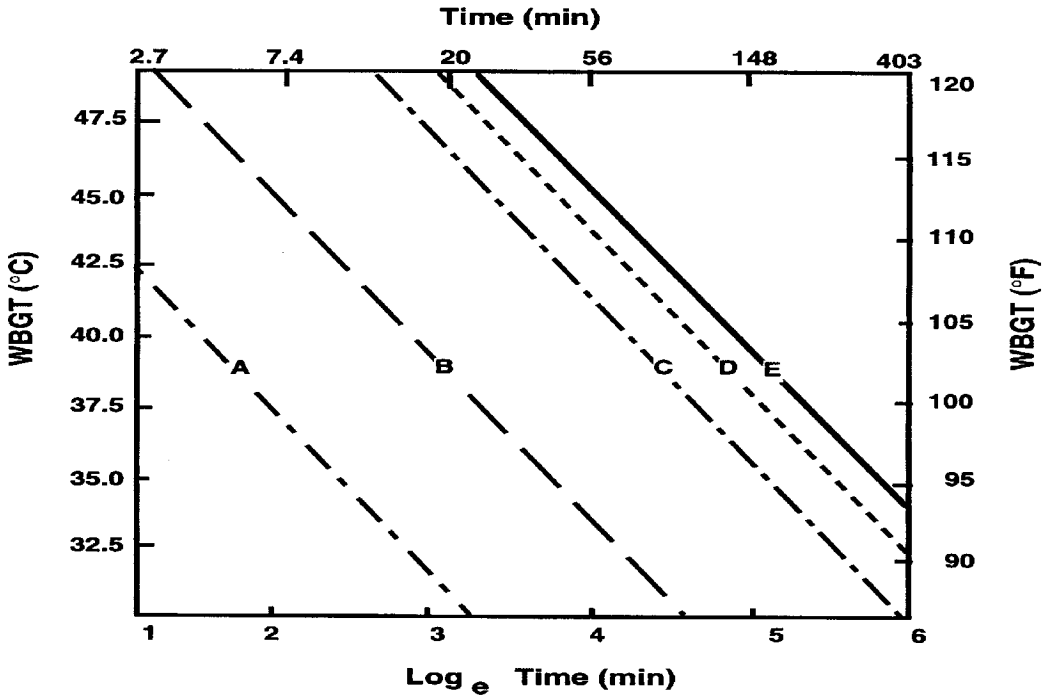

FIGURE 18.15 Human performance limits in the WBGT-log_e(Time) Cartesian space (A: vigilance performance, B: dual-task performance, C: tracking performance, D: simple mental performance, E: physiological tolerance). (From Hancock, P.A. and Vasmatazidis, I. 1998. Human occupational and performance limits under stress: The thermal environment as a prototypical example, *Ergonomics*, 44, 1169–1191. With permission of Taylor & Francis.)

TABLE 18.6 With respect to Figure 18.14, since the slope is common at -4.094 , designation of each performance limit curve, in °C, can be specified by a single intercept value. There are two crucial issues to note. As the zero point on the logarithmic base goes to infinity, the intercepts shown are purely pragmatic and are used to plot the lines within the time/intensity boundaries shown. Thus the tolerances should not be extended beyond the time/intensity limits illustrated without further experimental validation. Second, two intercepts have been presented. The first is derived solely from the empirical data, the second contains a conservative adjustment so that the designations can be used for acceptable tolerance standards.

Curve	Task type	Empirical intercept	Tolerance adjusted intercept
A	Vigilance performance	42.82	41.0
B	Dual-task performance	48.59	47.0
C	Tracking performance	53.96	53.0
D	Simple mental performance	55.81	54.0
E	Physiological tolerance	57.06	55.0

From Hancock, P.A. and Vasmatazidis, I. 1998. Human occupational and performance limits under stress: The thermal environment as a prototypical example, *Ergonomics*, 44, 1169–1191. With permission of Taylor & Francis.

to the design of operator tasks in future systems. Table 18.6 provides empirical and tolerance standard adjusted intercept values for each performance curve of Figure 18.14 when ET is expressed in terms of °C.

Although the linearity across the present plot allows for a simple mathematical description of tolerance, where task category performance threshold is defined by the intercept value, this linearity is not the only significance of the illustration. Each threshold also describes a particular dynamic rise in deep body temperature which corresponds to the limit of efficient performance on that task. This property permits

TABLE 18.7 With respect to Figure 18.15, the slope is common at -5.435 . Again, since the zero point on the logarithmic base goes to infinity, the intercepts shown are purely pragmatic and are used only to plot the lines within the time/intensity boundaries shown. The tolerances, therefore, may not be extended beyond the time/intensity limits illustrated without further experimental validation. Again, the empirical and tolerance adjusted intercepts are specified.

Curve	Task type	Empirical intercept	Tolerance adjusted intercept
A	Vigilance performance	48.02	46.0
B	Dual-task performance	55.68	54.0
C	Tracking performance	63.11	62.5
D	Simple mental performance	65.33	64.0
E	Physiological tolerance	66.56	65.0

From Hancock, P.A. and Vasmatazidis, I. 1998. Human occupational and performance limits under stress: The thermal environment as a prototypical example, *Ergonomics*, 44, 1169–1191. With permission of Taylor & Francis.

a transcription of performance limits from the effective temperature–time domain to the wet-bulb globe temperature (WBGT)–time domain. Since WBGT has replaced ET as the principal measure of the thermal load in most of the experimental studies conducted during the last decades, this transcription is illustrated next. Consequently, WBGT was the index incorporated in the two most recent NIOSH heat stress recommended standards (NIOSH, 1972, 1986) and several other international standards (Parsons, 1995).

A direct translation between ET and WBGT cannot be accomplished through the physical properties of the atmosphere without knowledge of the radiant heat value in the respective ET environment. In the paper by Ramsey and Kwon (1992) this translation was accomplished by estimation of conditions in the absence of reported data. However, a knowledge of the rate of rise of body temperature against WBGT can act as an alternate source of translation. This translation is accomplished by a link derived from the work of Jensen and Heims (1976). The procedure presented here, and the estimates of Ramsey and Kwon (1992) are both superior to the unfounded equivalence between ET and WBGT assumed in the NIOSH (1972) document for drawing the curve concerning the heat stress-related performance limits as given by Wing (1965). This whole question of index selection and transcription process is worthy of further study (Parsons, 1993). For the purpose of the present work, the transcription of performance limits was accomplished by employing the information in Jensen and Heims (1976). The new threshold curves are presented in Figure 18.16, where the respective thresholds for vigilance, dual-tasks, neuromuscular coordination tasks, simple mental performance, and physiological tolerance are 0.055°C , 0.22°C , 0.88°C , 1.33°C , and 1.67°C dynamic increase in body temperature, respectively. The negative slope b in Equation 2 is 5.435 . The empirical and tolerance adjusted intercept values for each performance category in terms of WBGT as $^{\circ}\text{C}$ values are provided in Table 18.7. The equation describing the lines in Figure 18.15 takes the general form of:

$$\text{WBGT} = a - b \log_e T \quad (2)$$

with the empirical constants as noted in the text and indicated in the appropriate table.

Within the scale ranges described earlier, it is suggested that the performance limits in Figures 18.14 and 18.15 provide the upper tolerance levels of performance in each of the task categories. These limits represent the points of statistical degradation when compared to performance in a thermoneutral condition. We do not enter here into arguments that have surrounded the methodological limitations inherent in designs which use such pairwise within-subject comparisons, nor in the argument which contrasts statistical against substantial real-world performance degradation. Suffice it to note that these are not necessarily coincident. Rather, the boundaries should be thought of as critical failure points along an exponential curve relating performance to stress intensity, the latter being the product of exposure time and exposure temperature. Figure 18.15 indicates that, as with the observations of Ramsey and Morrissey (1978), there is a series of contours which describe states of performance degradation for which the threshold of significant decrement can be regarded as one major feature. However, unlike

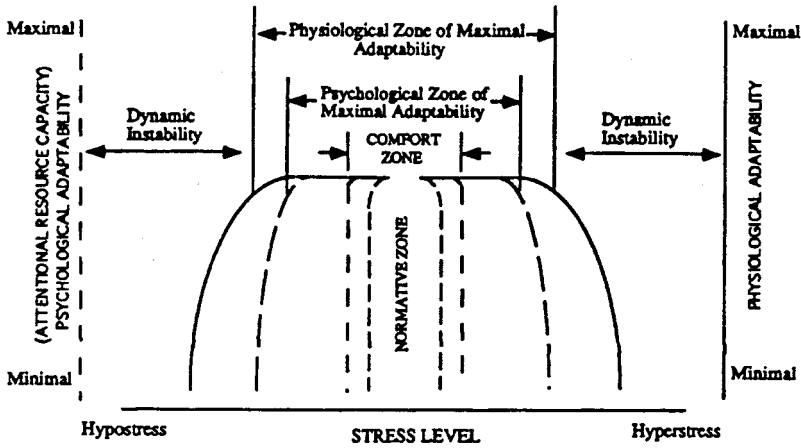

FIGURE 18.16 The maximal adaptability model. (From Hancock, P.A. and Warm, J.S. 1989, A dynamic model of stress and sustained attention, *Human Factors*, 31, 519-537. With permission.)

Ramsey and Morrissey (1978), we observe that the pattern in which these contours occur represents geometric degradation rather than the linear relationships shown in their work. The tasks referred to in the latter part of this chapter are all performed without substantive levels of muscular work. However, boundary conditions to performance decrement in terms of dynamic increases in deep body temperature may serve as useful limits even if one source of heat stress, e.g., the environment, is augmented with another source, e.g., physical activity. In essence, the present limits can accommodate situations in which the worker has to be both physically and mentally active at the same time.

18.8 Theoretical Foundation of the Limits Derived

The physiological limits of tolerance to heat and associated criteria as developed in the most recent NIOSH document are founded upon a solid body of knowledge concerning human physiological response. Thus, it is incumbent to demonstrate comparable theoretical foundations for performance-based criteria. This has been presented in recent work (Hancock and Warm, 1989) and is considered here. The theory is founded upon a direct link to physiological degradation. The lack of a single coherent theoretical framework that accounts for experimental findings is the weakest point in heat stress literature as related to mental performance and for that matter in the stress literature in general. By far, the most popular theory has been the behavioral arousal account (Duffy, 1962; Provins, 1966; Poulton, 1977) which postulates an inverted-U relationship between the arousal level of the individual and the level of environmental stress. However, this position is unfalsifiable and can account for almost any pattern of data in a *post hoc* manner. Thus, it has often been invoked by researchers unable to find any other explanation for seemingly contradictory sets of data (see Hancock, 1987, for a critique of behavioral arousal theory). Without reference to a theoretical structure, there is no rationale, other than empirical separation, for dividing results into different performance categories.

In this work we have divided tasks on the basis of attentional demands. Therefore, we have used attentional characteristics and their variation under stress as the theoretical basis for our defined limits. This variation of attentional characteristics in the presence of environmental stress is accounted for in detail by the maximal adaptability model (Hancock and Warm, 1989) which is reproduced in Figure 18.16. This model assumes that heat exerts its detrimental effects on performance by competing for and eventually draining attentional resources (Kahneman, 1973).

Briefly, in Figure 18.16, the base axis is similar to Selye's (1956) conception of stress ranging from extremes of underload (hypostress) to extremes of overload (hyperstress). In the middle of this range is an area of minimal stress (normative zone) which requires no active compensatory effort on the part of

the individual. Surrounding the normative zone is the comfort zone in which cognitive adjustments to task demands are easily obtained, and therefore performance remains near to optimal. As the level of stress increases away from this zone, attentional resources are progressively drained. Initially, the remaining resources are efficiently used by the individual, with the net result being no performance decrement, and, on occasion, some performance enhancement. This behavioral pattern is a reflection of psychological adaptability and is observed inside the zone of maximal psychological adaptability. At higher stress levels, depletion of attentional resources causes progressive failure of task efficiency (see dashed line in Figure 18.17 comprising the boundary of the psychological zone of maximal adaptability; see also Hancock, 1986b, for a more detailed discussion). Finally, extreme levels of stress move the individual outside the zone of homeostasis (physiological zone of maximal adaptability), toward the region of dynamic instability, a life-threatening condition, such as is found in heat stroke, for example.

As illustrated in Figure 18.16, rather than an inverted U-shaped function, the maximal adaptability model proposed an extended U-shaped function in which three modes of operation are represented. The first, the flat ceiling of the extended-U, represents a mode of operation in which dynamic stability predominates. Second, at the shoulders of the extended-U, there are regions of transitions which, in the generic case of multiple stress exposure, might be represented as discontinuities using the morphology of catastrophic failure (Zeeman, 1977). Finally, the arms of the extended-U are dynamically unstable and in the present circumstances represent incipient failure. Another characteristic of the model is its symmetrical nature. Using engineering terms, this feature implies that strain increases symmetrically with progressive deviation from the central, normative zone. The function of this increase in strain is given by the solid line in Figure 18.17, and replicates the geometric functions noted above for heat stress. The strain function is the same for both physiological and behavioral degradation, but the parameters of the curves differ, signifying that behavior is affected before physiological effects are observed. The maximal adaptability model assumes initially that heat drains attentional resources from a single, undifferentiated resource pool. A methodology for expanding the model to incorporate multiple resource pool theories was provided by Vasmatzidis and Schlegel (1994). Recently, the maximal adaptability model has served as the basis for an experimental investigation of multiple task performance under heat stress (Vasmatzidis et al., 1995) and extensive work on the effects of stress and fatigue on a variety of real-world tasks (Desmond and Matthews, 1996; Matthews and Desmond, 1995; Matthews, Sparkes, and Bygrave, 1996). For full details of the model, see Hancock and Warm (1989).

18.9 Implications for All Stress Criteria

The present work has implications for developing exposure criteria for all types of occupational stress. Previous derivations of exposure criteria have been founded upon medical science, and the developed criteria are intended to ensure the healthy functioning of the human physiological system. Ergonomists are comfortable with this approach since physiology is the basis of historical ergonomics standards. However, the change in the nature of contemporary work has broad and far-reaching effects. With respect to the present work, the principal effect is the transformation of the currency of work from physical energy to information. This is not to say that there are not many situations in which physical work is not of continued importance; there are. However, this is to recognize that the predominant currency of the work environment is now information in nature. Consequently, cognitive performance and associated mental error are major concerns for today's human factors and systems specialist, as physical injury has been for the traditional ergonomist.

In the past, injuries were physical, and criteria were derived to protect against such physical sources of occupational threat. Today, in large part, the emphasis has shifted from physical over-exertion to cognitive over-exertion or more appropriately, maladaptation (Hancock and Warm, 1989; see also Miller, 1960). In this chapter we have argued that heat stress exposure criteria which are designed to protect against physical harm do not always suffice for cognitive work. Our assertion is that the active central nervous system and its performance output is the most vulnerable element of the worker. Thus, it is

performance that needs to be protected and consequently should comprise the focus of future heat stress exposure criteria.

In addition, we wish to propose that the present log-linear space description is not constrained to heat stress alone. Rather, we suggest that many sources of stress such as noise and vibration can be captured using the same form of description and the same underlying model, although the parameters of the space are expected to change depending on the specific nature of stress involved. Thus, the present framework can serve as a basis for understanding the multiple interaction of stresses which has always been a problematic issue (Hancock and Pierce, 1985). The great advantage of the present construct is the employment of attention as the basis for our formulation. Consequently, the different cognitive demands of the tasks, which themselves are frequently the main source of occupational stress, can be easily incorporated into our framework. No previous proposals have allowed the inclusion of such a critical contemporary work factor into exposure limitations.

18.10 Summary and Conclusions

The 19th and the early 20th centuries have been characterized as the industrial age, whereas the late 20th century and the millennium are better described as the information age. The associated transformation of human work has had its effects on all segments of society but on none so much as on those who seek to understand, describe, and use the laws of work to our collective benefit. In its foundation and growth, ergonomics has sought to protect the worker from sources of threat so that work can be carried on in a safe and productive manner. However, many of the stress exposure criteria that seek to attain this goal need to be supplemented in the light of the changing nature of work. We argue, and have elaborated on the specific example of exposure to heat stress, that the basis of worker protection must shift solely from physiological concerns to embrace psychological issues. Thus, cognitive science with its study of neuropsychological capabilities must play a much greater, if not primary, role in the development of the exposure criteria than they have done to date.

Fortunately, physiological and psychological response to stress can be promoted within a common framework which emphasizes their similarities, not their disparities. Thus, exposure criteria can be developed which integrate an understanding of behavioral response to work demands with physiological adjustment to environmental conditions. Such a unified framework promises to provide a new foundation for establishing worker protection from all sources of threat to health, safety, and performance.

Acknowledgment

We have, in this work, purposefully, relied heavily upon our previously reported work concerning the issue of behavioral limits, since we view this development as crucial for practicing occupational ergonomists. We would, therefore, very much like to thank the editors and publishers involved for their kind permission to reproduce such work. In particular we thank Taylor & Francis as the publisher and the journal editor for this valued agreement.

References

- American Conference of Governmental Industrial Hygienists, ACGIH 1986, *Threshold Limit Values and Biological Exposure Indices for 1986-87* (Cincinnati, Ohio).
- Allan, J.R., Gibson, T.M., and Green, R.G. 1979, Effects of induced cyclic changes of deep body temperature on task performance, *Aviation, Space and Environmental Medicine*, 50, 585-589.
- Azer, N.Z., McNall, P.E., and Leung, H.C. 1972, Effects of heat stress on performance, *Ergonomics*, 15, 681-691.
- Belding, H.S. and Hatch, T.F. 1955. Index for evaluating heat stress in terms of resulting physiological strains, *Heating, Piping and Air Conditioning*, 129-136.

- Blockley, W.V. and Lyman, J.H. 1950, *Studies of Human Tolerance for Extreme Heat: III. Mental Performance Under Heat Stress as Indicated by Addition and Number Checking Tests* (USAF technical report 6022, Wright-Patterson Air Force base, Ohio).
- Blockley, W.V. and Lyman, J.H. 1951, *Studies of Human Tolerance for Extreme Heat: IV. Psychomotor Performance of Pilots as Indicated by a Task Simulating Aircraft Instrument Flight*, (USAF technical report 6521, Wright-Patterson Air Force base, Ohio).
- Botsford, J.H. 1971, A wet globe thermometer for heat stress evaluation. *American Industrial Hygiene Association Journal*, 32, 17-25.
- Burton, A.C. 1934, The application of the theory of heat flow to the study of energy metabolism, *Journal of Nutrition*, 7, 497.
- Burton, A.C. and Edholm, O.G. 1955, *Man in a Cold Environment*. Arnold: London.
- Chiles, W.D. 1958, Effects of elevated temperatures on performance of a complex mental task, *Ergonomics*, 2, 89-96.
- Desmond, P.A. and Matthews, G. 1996, Task-induced fatigue effects on simulated driving performance, in A.G. Gale (Ed.). *Vision in Vehicles VI*, (Amsterdam: North-Holland).
- Duffy, E. 1962, *Activation and Behavior*. Wiley, New York.
- Dukes-Dobos, F.N. 1976, Rational and provisions of the work practices standard for work in hot environments as recommended by NIOSH, in *Standards for Occupational Exposures to Hot Environments*, (S.M. Horvath and R.C. Jensen, Eds.) NIOSH publication No. 76-100, Cincinnati, OH.
- Enander, A.E., and Hygge, S. 1990, Thermal stress and human performance, *Scandinavian Journal of Work and Environmental Health*, 16, 44-50.
- Epstein, Y., Keren, G., Moisseiev, J., Gasko, O., and Yachin, S. 1980, Psychomotor deterioration during exposure to heat, *Aviation, Space and Environmental Medicine*, 51, 607-610.
- Fanger, P.O. 1972, *Thermal Comfort*. McGraw-Hill, NY.
- Grandjean, E. 1988, *Fitting the Task to the Man*. 4th Edition. Taylor and Francis: New York.
- Grether, W.F. 1973, Human performance at elevated environmental temperatures, *Aerospace Medicine*, 44, 747-755.
- Hancock, P.A. 1980, Mental performance impairment in heat stress, *Proceedings of the Human Factors Society*, 24, 363-366.
- Hancock, P.A. 1981, Heat stress impairment of mental performance: A revision of tolerance limits, *Aviation, Space and Environmental Medicine*, 52, 177-180.
- Hancock, P.A. 1982, Task categorization and the limits of human performance in extreme heat, *Aviation, Space and Environmental Medicine*, 53, 778-784.
- Hancock, P.A. 1984, Effects of environmental temperature on display monitoring performance: An overview with practical implications, *American Industrial Hygiene Association Journal*, 45, 122-126.
- Hancock, P.A. 1986a, The effect of skill on performance under an environmental stressor, *Aviation, Space and Environmental Medicine*, 57, 59-64.
- Hancock, P.A. 1986b, Sustained attention under thermal stress, *Psychological Bulletin*, 99, 263-281.
- Hancock, P.A. 1986c, Stress and adaptability, in G.R.J. Hockey, A.W.K. Gaillard and M.G.H. Coles (Eds.), *Energetics and Human Information Processing* (Martinus Nijhoff, Dordrecht, The Netherlands), 243-251.
- Hancock, P.A. 1987, Arousal theory, stress and performance: Problems of incorporating energetic aspects of behavior onto human-machine systems function, in L.S. Mark, J.S. Warm and R.L. Huston (Eds.), *Ergonomics and Human Factors: Recent Research* (Springer-Verlag, New York), 170-179.
- Hancock, P.A., and Pierce, J.O. 1985, Combined effects of heat and noise on human performance: A review, *American Industrial Hygiene Association Journal*, 46, 555-566.
- Hancock, P.A. and Warm, J.S. 1989, A dynamic model of stress and sustained attention, *Human Factors*, 31, 519-537.
- Hancock, P.A. and Vasmatazidis, I. 1998, Human occupational and performance limits under stress: The thermal environment as a prototypical example. *Ergonomics*, 41, 1169-1191.

- Hancock, P.A. and Vercruyssen, M. 1988, Limits of behavioral efficiency for workers in heat stress, *International Journal of Industrial Ergonomics*, 3, 149-158.
- Hardy, J.D., Gagge, A.P., and Stolwijk, J.A.J. 1970, *Physiological and Behavioral Temperature Regulation*. Thomas: Springfield, IL.
- Hockey, G.R.J. 1986, Changes in operator efficiency as a function of environmental stress, fatigue and circadian rhythms, in K.R. Boff, L. Kauffman and J.P. Thomas (Eds.), *Handbook of Perception and Human Performance* (Wiley, New York), Chapter 44.
- Houghten, F.C. and Yagloglou, C.P. 1923, Determining lines of equal comfort, *Transactions of the American Society of Heating and Ventilating Engineers*, 29, 163-176.
- Houghten, F.C. and Yagloglou, C.P. 1923. Determination of the comfort zone. *American Society of Heating and Ventilating Engineers*, 29, 515-536.
- Iampietro, P.F., Chiles, W.D., Higgins, E.A., and Gibbons, H.L. 1969, Complex performance during exposure to high temperatures, *Aerospace Medicine*, 40, 1331-1335.
- International Organization for Standardization, ISO (7243) 1989, *Hot Environments-Estimation of the Heat Stress on Working Man Based on WBGT Index*, ISO 7243 (Geneva, Switzerland).
- Jensen, R.C. and Heims, D.A. 1976, *Relationships between Several Prominent Indices* (NIOSH-Pub No. 77-109).
- Kahneman, D. 1973, *Attention and Effort*. Englewood Cliffs, Prentice Hall, New Jersey.
- Kantowitz, B.H. and Sorkin, R.D. 1983, *Human Factors: Understanding People-System Relationships*. John Wiley & Sons, New York.
- Kerslake, D. McK. 1972, *The Stress of Hot Environments*. Cambridge University Press: Cambridge.
- Konz, S. 1983, *Work Design: Industrial Ergonomics*, 2nd Ed., John Wiley & Sons, New York.
- Lind, A.R. 1963, Physiological effects of continuous or intermittent work in the heat, *Journal of Applied Physiology*, 18, 57-60.
- Matthews, G. and Desmond, P.A. 1995, Stress as a factor in the design of in-car driving enhancement systems, *Le Travail Humain*, 58, 109-129.
- Matthews, G., Sparkes, T.J., and Bygrave, H.M., Stress, attentional overload, and simulated driving performance, *Human Performance*, 9, 77-101.
- McConnell, W.J. and Yagloglou, C.P. 1925, Work tests conducted in atmospheres of high temperatures and various humidities in still and moving air, *Journal of the American Society of Heating and Ventilation Engineers*, 31, 217-221.
- McIntyre, D.A. 1980, *Indoor Climate*. Applied Sciences Publishers: Essex, England.
- Meister, A. 1976, Heat exposure, performance reliability and efficiency, *Zeitschrift fur Psychologie Mit Zeitschrift fur Angewandte Psychologie*, 184, 63-72.
- Millar, J.D. 1986, Foreword in: *Criteria for a Recommended Standard: Occupational Exposure to Hot Environments*, revised criteria (NIOSH pub No. 86-113).
- Miller, J.G. 1960, Information input overload and psychopathology, *American Journal of Psychiatry*, 116, 695-704.
- Millican, R., Baker, R., and Cook, G. 1981, Controlling heat stress: Administrative vs. physical control, *American Industrial Hygiene Association Journal*, 42, 411-415.
- National Institute for Occupational Safety and Health (NIOSH) 1972, *Criteria For a Recommended Standard-Occupational Exposure to Hot Environments* (NIOSH Publication No. 72-10269).
- National Institute for Occupational Safety and Health (NIOSH) 1973, *The Industrial Environment, Its Evaluation and Control*. U.S. Government Printing Office, Washington, D.C. (p. 419).
- National Institute for Occupational Safety and Health (NIOSH), 1981, *Proceedings of a Workshop on Recommended Heat Stress Standards*. F.N. Dukes-Dobos and A. Henschel (Eds.). National Institute for Occupational Safety and Health, Cincinnati, OH 81-08.
- National Institute for Occupational Safety and Health (NIOSH) 1986, *Criteria for a Recommended Standard: Occupational Exposure to Hot Environments* revised criteria (NIOSH Publication No. 86-113).
- National Safety Council. 1988, *Fundamentals of Industrial Hygiene*. 3rd Edition, Washington, D.C.

- Nunneley, S.A., Dowd, P.J., Myhre, L.G., Stribley, R.F., and McNee, R.C. 1979, Tracking-task performance during heat stress simulating cockpit conditions in high-performance aircraft, *Ergonomics*, 22, 549-555.
- Parsons, K.C. 1995, International heat stress standards: A review, *Ergonomics*, 38, 6-22.
- Parsons, K.C. 1993, *Human Thermal Environments*. Taylor & Francis, London.
- Pepler, R.D. 1958, Extreme warmth and sensorimotor coordination, *Journal of Comparative and Physiological Psychology*, 14, 383-486.
- Poulton, E.C. 1977, Arousing stresses increase vigilance, in R.R. Mackie (Ed.) *Vigilance: Theory, Operational Performance and Physiological Correlates* (Plenum Press, New York), 423-459.
- Provins, K.A. 1966, Environmental heat, body temperature and behavior: An hypothesis, *Australian Journal of Psychology*, 18, 118-129.
- Ramsey, J.D. 1995, Task performance in heat: A review, *Ergonomics*, 38, 154-165.
- Ramsey, J.D., Dayal, D., and Ghahramani, B. 1975, Heat stress limits for the sedentary worker, *American Industrial Hygiene Association Journal*, 36, 259-265.
- Ramsey, J.D. and Kwon, Y.G. 1992, Recommended alert limits for perceptual motor loss in hot environments, *International Journal of Industrial Ergonomics*, 9, 245-257.
- Ramsey, J.D. and Morrissey, S.J. 1978, Isodecrement curves for task performance in hot environments, *Applied Ergonomics*, 9, 66-72.
- Rohles, F.H., and Konz, S.A. 1987, Climate, in G. Salvendy. *Handbook of Human Factors*, Wiley, New York.
- Sanders, M.S. and McCormick, E.J. 1987, *Human Factors in Engineering and Design*, 6th Ed., McGraw-Hill, New York.
- Selye, H.A. 1956, *The Stress of Life*. McGraw-Hill, New York.
- Taylor, C.L. 1948, *Interim Report to the Committee on Aviation Medicine*, National Research Council (Washington, D.C.).
- Vasmatazidis, I. and Schlegel, R.E. 1994, A methodology for investigating heat stress selectivity effects on mental performance, *Proceedings of the Human Factors and Ergonomics Society 38th Annual Meeting* (Human Factors and Ergonomics Society, Santa Monica, CA), 510-514.
- Vasmatazidis, I., Schlegel, R.E., Purswell, J.L., and Hancock, P.A. 1995, Cognitive resource depletion under heat stress, *Proceedings of the Konz/Purswell Occupational Ergonomics Symposium*, 91-98.
- Wing, J.F. 1965, Upper thermal tolerance limits for unimpaired mental performance, *Aerospace Medicine*, 36, 960-964.
- Yaglou, C.P. and Minard, D. 1957, Control of the heat casualties at military centers *AMA Archives of Industrial Health*, 16, 302-310.
- Zeeman, E.C. 1977, *Catastrophe Theory: Selected Papers 1972-1977* (Addison-Wesley, Reading, Massachusetts).

19

Work Shift Usability Testing

19.1	Work Shift Usability.....	19-1
	Introduction • History • Terminology • Basic Concepts • Sleep as a Benchmark • Work Schedule Impact Model • Work Shift Usability — Summary	
19.2	Work Shift Assessment	19-9
	Introduction • Preliminary Assessment • Initial Assessment • Formal Assessment	
19.3	Workplace Assessment	19-13
	Introduction • Work Shift System Selection	
19.4	Work Shift Implementation	19-15
19.5	Summary	19-16

Donald I. Tepas
University of Connecticut

19.1 Work Shift Usability

Introduction

The term *shift* is used in a variety of ways. In the most general usage, shift refers to the hours of a given day that an individual or a group of individuals is scheduled to be in the workplace. Often, this term is used in a more restricted way, where shift refers only to a specific category of work hours, defined by practices at a specified location. In many cases these hours are viewed as undesirable, nontraditional, exceptional, or unusual. The more general usage will be used here, since process and practice developments in recent years make it very difficult to define what is exceptional or unusual. Presser (1995) has clearly demonstrated that work hours for the majority of Americans are not restricted to the traditional image of regular daytime weekday work of 35 to 40 hours per week.

The industrial revolution and the factory system began with long workdays and gradually moved to a workday of eight or fewer hours. It was the hope of many workers that continued innovation would lead to further reductions in work hours and an increase in worker participation in work hour selection (Tepas, 1985). For the most part, these expectations have *not* been realized in the United States. Instead, we are now in the early days of a new technological revolution whose key components often include automation, flexible manufacturing systems, and around-the-clock operations. In many of these cases, the resulting work schedules are driven by computer systems that do not consider human limitations or preferences. All too often, this failure to address the limits of the human components results in workers with less work hour flexibility, around-the-clock work hours, extended workdays, and/or irregular work hours. These failures suggest the “misapplication hypothesis.” This hypothesis proposes that the inappropriate application of advances in technology often decreases workplace performance and increases worker stress, fatigue, illness, and injury (Tepas, 1994).

ASSESSMENT OF WORK SCHEDULES

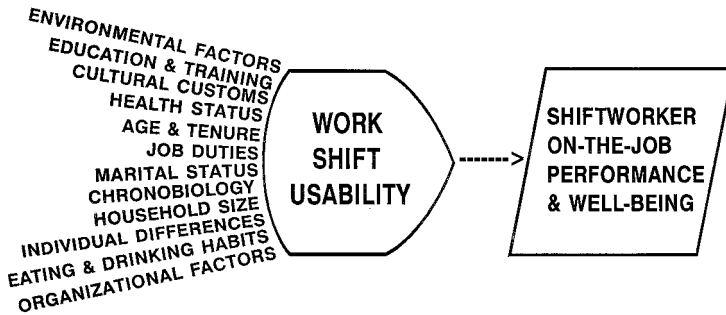

FIGURE 19.1 The major variables which have been related to shift worker performance and well-being.

History

Although night work has existed for centuries, the laws governing night and shift work in the United States cover only a very small percentage of the total workforce (Steinberg, 1982). These laws originated mainly prior to World War II, and they are based mostly on political and economic issues present at the time they were enacted. Research interest in shift work issues evolved after World War II, as the scientific and business community became more sensitive to the problems of night work. On an international level, work shift specialists have been organized since 1957, meeting on a regular basis as the Scientific Committee on Night and Shiftwork of the International Commission on Occupational Health. These meetings have resulted in a regular stream of dedicated book and journal publications. The result is an international and interdisciplinary literature which has been instrumental in increasing our awareness of the cultural, biological, and psychosocial issues which have a demonstrated impact on the health, safety, and/or performance of shift workers.

It is now quite clear that impact of night and shift work is always determined by multiple variables. Thus, a systems approach to work schedule assessment, design, and selection is in order. Figure 19.1 provides a listing of some of the major variable categories which have been related to shift worker on-the-job performance and well-being. The combined effect of these variables determines work shift usability. *Work shift usability testing* is aimed at the assessment and installation of work schedules whereby there is a good match between work shift usability and worker performance and well-being. This is the primary topic of this chapter. It is beyond the scope of this chapter to review all of the evidence confirming each of the categories listed in Figure 19.1, their operation, or all of the variable interactions which occur. Instead, some basic shift work concepts will be presented and an approach to the assessment of work shift usability testing will be outlined.

In the past, work shift assessment and the design of work shift systems have been purveyed by conventional managers or subordinates directed by these managers. This do-it-yourself approach is no longer appropriate or adequate. The work shift literature is much too vast, diverse, and difficult to locate and comprehend. Work shift options are expanding and fraught with hazards to be avoided. Contemporary work shift assessment and/or design projects require the skills of a trained work shift usability specialist. This chapter provides an introduction to the methods, terminology, and concepts of a work shift usability specialist. It should be viewed as a guide and introduction to a complex problem area, not an exhaustive review of the literature.

Terminology

The impact of cultural and social variables on the evolution of contemporary shift work systems is evident in the diversity of the terminology and practices which exist in the workplace. Table 19.1 provides some operational definitions for the shift work terms to be used in this chapter. Shift work as a term applies

TABLE 19.1 Definitions for Shift Work Terms, as Used in This Chapter

Term	Definition
First shift	Often called the day or morning shift, this is a work time period of about 8 h in duration which mainly falls between the hours of 0600 and 1700.
Second shift	Often called the afternoon-evening shift or swing shift, this is a work time period of about 8 h in duration which mainly falls between the hours of 1500 and 0100.
Third shift	Often called the night or graveyard shift, this is a work time period of about 8 h in duration which mainly falls between the hours of 2200 and 0700.
Shift break	A time period within a shift when work is not scheduled, under usual conditions. Usually less than 1 h long. When longer, it is often termed a split-shift.
Permanent hours	Fixed work hours whereby the shift work time period of an individual does not change under usual conditions.
Rotating hours	Changing work hours period whereby an individual works more than one shift time period, with the sequence of consecutive work time period types following a set and regular schedule under usual conditions.
Irregular hours	Changing work hours whereby the hours an individual works vary, or are perceived to vary, in a very irregular or unpredictable way as a usual condition.
Compressed hours	Any shift type which on a regular basis includes one or more work time periods longer than 8 h which results in a workweek of less than 5 full days.
Continuous operations	A workplace or position which employs shifts around-the-clock and on every day of the week.
Discontinuous operations	A workplace or position which does <i>not</i> employ shifts around-the-clock and on every day of the week
Nonworkday	Also called an off-day or day-off, this is a calendar day in which no work is scheduled. For some schedules this is a time period less than 24 h in duration.

when more than one of these terms applies to a given workplace. Definitions like these are needed if one is to begin to comprehend the international literature on shift work and attempt to apply it in an intelligent manner.

The definition for the *first shift* (day shift) provides a good example of the diversity of practice which exists in the literature, and why definitions are needed. Contrary to the definition in Table 19.1, a few workplaces in the U.S. refer to the night shift as the first shift, starting around midnight. Consistent with our definition, however, most United States workplaces start the first shift around 0700 to 0800. In Scandinavian countries a 0500 starting time is common. Spain provides a further contrast, since there a starting time of 0900 or later does not appear to be unusual.

Another example of differences in practice relates to how the hours of work are usually scheduled. *Permanent* hours are common in the United States, but approached with caution and special laws in Austria. The rate at which *rotating hours* are changed in the United States is much slower than that practiced by many European workplaces. In the United States, changing shifts once per week is usually considered to be a rapid rotation rate. European investigators term this a slow rotation rate, since some change shifts several times each week. Some specific examples of these, as well as a more detailed notation system, are described in Tepas, Paley, and Popkin (1997).

Differences in practice and/or preference like these and others make it quite difficult for the inexperienced reader to accurately compare shift work findings. One cannot simply accept the labels attached by users or experts to the work schedules they note in their publications and reports. In using work hour labels and definitions, you should recognize that they frequently use historical and colloquial terms which may not match your own usage. As the diversity and variety of work shift systems increase, the importance of using a detailed notation system increases. Work shift presentations without operational definitions and work hour details can be misleading and perhaps dangerous.

Basic Concepts

Chronobiology is one of the shift work variables listed in Figure 19.1. Although it should never be considered the main or only variable in the design of a work shift system, it is the basis of some special

problems which all night workers must face. Just as many animals are nocturnal beings, research in the last 20 years has clearly demonstrated that people are *diurnal*. That is, each of us has an internal biological clock. This endogenous clock has a natural cycle of about 25 h, but on earth it adjusts to around 24 h as it is entrained by the daily changes in light and dark. Concomitant with this cycle are daily variations in most, if not all, biological systems. These variations are termed *circadian* (from the Latin *circa*, about, and *dies*, a day) variations, since they cycle daily. For the human, this usually translates into an animal who is most likely to be working during the daylight and sleeping during the night. Consistent with this, human societies and cultures are, for the most part, circadian and diurnal.

Changing the shift one works, for example, from the first shift to the third shift, may require many changes. For this example, after the change one would work during the night and sleep after work during the day (Tepas and Carvalhais, 1990). This is a change in both the order and time-of-day of sleep. Although the human biological clock does make small adjustments every day to keep in phase with the seasonal changes in daylight, research on humans in controlled environments suggests that large changes like this are very difficult and take many days. Thus, it may be that in a real workplace *total* adjustment of the biological clock to a new work shift is limited and may not be desirable.

Since we most often live in a society and culture which is mainly day-orientated, total adjustment of social circadian variations may be even more limited. Thus, the demands of a change in work shift are at their least difficult for some, and at their worst may be impossible for others. For the human factors specialist, two work shift design strategies are suggested by these biological and social limitations. On the one hand, one might design and implement schedules which *minimize* the need for large adjustments in biological and social variables, thereby trying to maintain existing circadian variations. At the other extreme, one might implement work shift designs and conditions which require large adjustments *and* at the same time *facilitate changes* in the circadian variations. Both of these alternative strategies have been used, and each has advantages and disadvantages. Work shift usability testing should keep these two strategies in mind, since they make clear that there are often several alternative solutions to a given work shift design problem.

Sleep as a Benchmark

The concept of a *benchmark* comes to us from the work of land surveyors. A benchmark is a discretionary mark made by a surveyor on a permanent landmark that has a known position and altitude. The benchmark is then used as a reference point in determining other locations. When the appropriate reference marks are needed, the sleep length of workers has proven to be a fairly robust variable for surveying the impact of work shifts.

In general, there are large individual differences in the usual sleep length of humans. These differences make it very difficult to predict, in advance, all work shift problems within an individual. On the other hand, sleep length has a demonstrated value as a good tool for the *actuarial* analysis (group prediction) of work shift impact (Dekker, Tepas, and Colligan, 1996). For discussion purposes, sleep length will be used as a marker as this chapter provides the reader with an introduction to shift work issues.

Figure 19.2 shows the major sleep length periods of a diverse sample of experienced shift workers on discontinuous operations with *permanent* hours (Tepas and Carvalhais, 1990). Mean sleep length is presented for each of the three shift types on workdays and non-workdays. The differences between shift types on workdays are significant and similar to those reported in many studies: workers on the third shift sleep least; those on the second shift sleep the most; and the first shift is somewhere in between. For all three shift types, non-workday sleep is significantly longer than workday sleep, but the differences between shift types on non-workdays are *not* significant. Workday sleep length has a small but significant *positive* correlation with non-workday sleep length. Thus, workday sleep reductions are not fully replaced by non-workday sleep.

A number of additional characteristics of shift work are demonstrated in Figure 19.3. These data are from fire fighters on *rotating* hours (Paley and Tepas, 1994). For this analysis, the fire fighters were divided into senior and junior groups. Junior fire fighters had from 1.2 to 3.7 years of shift work exposure, and

**WORKDAY AND NON-WORKDAY MAJOR SLEEP PERIODS
AS REPORTED BY WORKERS ON PERMANENT SHIFTS**

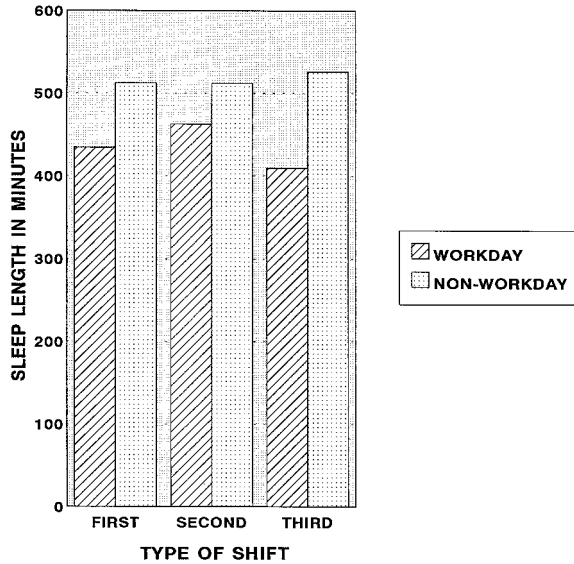

FIGURE 19.2 Mean major sleep length on workdays and non-workdays. Data graphed from a study of permanent discontinuous hourly shift workers. (From Tepas, D.I. and Carvalhais, A.B. (1990) Sleep patterns of shift workers, in A.J. Scott (Ed.) *Shiftwork*. Philadelphia: Hanley and Belfus. With permission.)

ranged in age from 22 to 43 years. Senior fire fighters had from 10.8 to 19.6 years of shift work exposure, and ranged in age from 30 to 59 years. The sleep length data for junior fire fighters are *not* significantly different from those of senior fire fighters. However, the type of shift sleep differences are significant and parallel those of permanent shift workers as demonstrated by Figure 19.2. It should also be noted that the third shift sleep of rotating workers is shorter than that of the permanent third shift workers.

Longitudinal studies of shift worker sleep have also confirmed that the reduction in sleep length associated with third shift work does *not*, as a general rule, disappear with repeated exposure. Radosevic-Vidacek, Vidacek, Kaliterna, and Prizmic (1995) have demonstrated that this reduction in sleep length associated with night work remains significant after five years of exposure to rotating hours. Gersten (1987), using age-matched samples of permanent first shift workers for additional control for age changes, confirms that the reduction in sleep length associated with third shift work remains significant after over six years of exposure to permanent hours. Interestingly, age and gender (Tepas, Duchon, and Gersten, 1993; Dekker and Tepas, 1990) do significantly interact with the third shift tenure effect.

In sum, sleep length is a significant benchmark for the impact of shift work on real shift work users. The data reviewed clearly indicate that work has an impact on worker sleep, that shift type is a significant factor, and that the daily impact of a shift schedule does not appear to fully disappear with exposure. This suggests that sleep length differences can be used to assess or monitor the impact of a work schedule on groups of workers for actuarial purposes, using appropriate norms.

Work Schedule Impact Model

Shift workers, as a rule, do *not* suffer from a sleep disturbance or disorder. They do frequently complain about their sleep and have sleep problems, as most people do (Howarth, Pratt, and Tepas, 1997). There is little evidence, however, to support the notion that most healthy workers when placed on shift work immediately manifest a disorder or disturbance which requires medical treatment or a special training program (Mahan, Carvalhais, and Queen, 1990; Cole, Loving, and Kripke, 1990; Tepas, 1993). In addition,

TENURE/AGE AND LENGTH OF MAJOR SLEEP PERIOD AS REPORTED BY WORKERS ON ROTATING HOURS

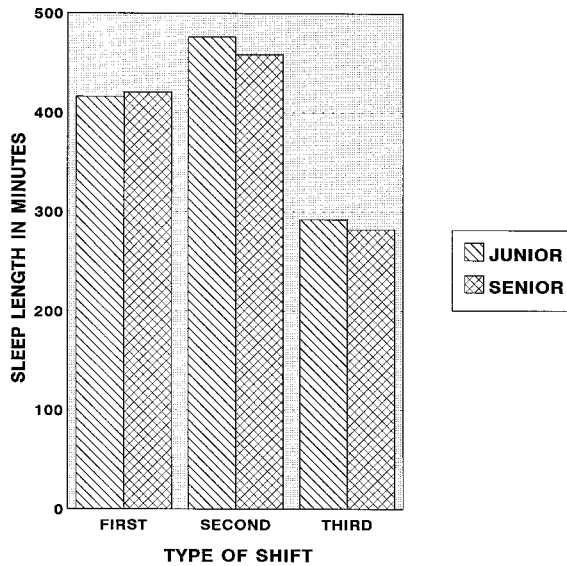

FIGURE 19.3 Mean major sleep length for fire fighters on rotating continuous shift work. The senior and junior groups differ in both their tenure on this schedule and their age. (Data graphed from Paley, M.J. and Tepas, D.I. (1994) The effect of tenure on fire fighter adjustment to shift work. Paper presented at the 23rd International Congress of Applied Psychology, Madrid, Spain.)

it is important to note that short- and long-term shift tolerance, like sleep deprivation, can be influenced by the impact of social factors (Monk, 1989). Evidence does suggest that *acute* (short-term) exposure to some work shifts and/or normal circadian variations in alertness does *increase* the probability of accidents and injury (Mittler, et al., 1988).

In the long run, however, *chronic* exposure to some work schedules most probably does lead to illness and injury (Knutsson, 1989; Kawachi et al., 1995; Harma, Seitsamo, and Ilmarinen, 1997). Thus, in practice, the impact of chronic exposure to a given work schedule may be quite different from that of an acute exposure (Tepas, 1982). The distinction between chronic and acute work shift impact is diagrammed in Figure 19.4. Bias from years of quality laboratory research has led many to overlook this distinction and assume that the impact of shift work can be easily predicted from existing laboratory research. This is not true. Field research results sometimes differ from laboratory results. A conservative user must assume that the impact of a work schedule varies with duration of exposure to shift work.

Using the sleep length data presented earlier (Tepas and Carvalhais, 1990) as a benchmark, Figure 19.5 provides an estimate of the *total accumulated sleep loss* (TASL) one might expect during 30 days on permanent discontinuous shift work. This is a frequently used shift work schedule in the United States. The reconstruction shown assumes that non-workday sleep length is a reasonable estimate of the amount of sleep needed, and it is based upon group means for these large samples. Since the three shift types do not vary in the length of their non-workday sleep length but do vary significantly in their workday sleep length, sleep loss carry-over or debt (TASL) increases as consecutive days on this schedule increase.

Given the increased health and safety risk exhibited in experienced long-term shift workers, it seems reasonable to assume that the chronic carry-over demonstrated by sleep length data may also hold for many of the variables listed in Figure 19.1. Figure 19.6 provides a graphical view of this general work shift carry-over model. The model assumes that health and safety risk increases whenever there is a negative carry-over of exposure impact from one day to the next day. It also assumes that multiple

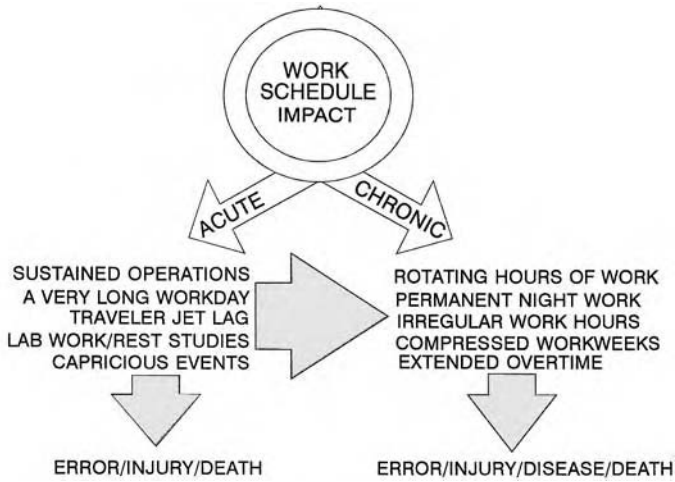

FIGURE 19.4 The distinction between chronic and acute work shift impact. The impact of a work shift may vary with duration of exposure.

**TOTAL ACCUMULATED SLEEP LOSS (TASL)
PERMANENT DISCONTINUOUS SHIFTWORK**

▲ NIGHT SHIFT ◆ DAY SHIFT ■ AFT/EVE SHIFT

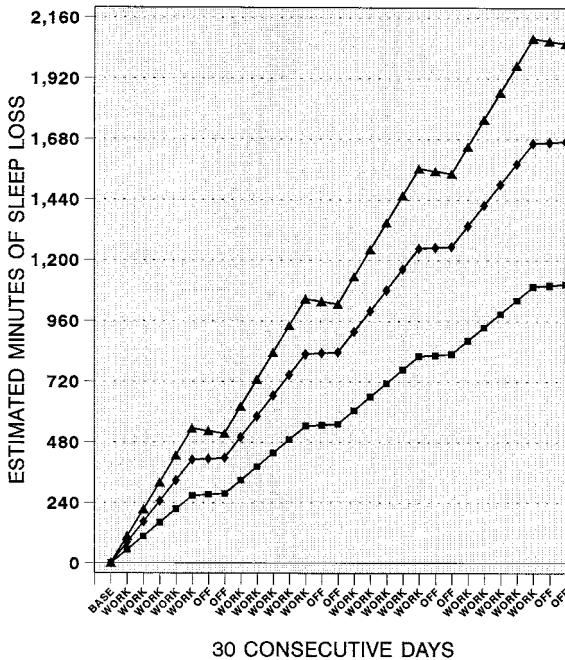

FIGURE 19.5 Estimated total accumulated sleep loss for workers on permanent discontinuous shift work over 30 consecutive days on this schedule. (Estimates based on data from Tepas, D.I. and Carvalhais, A.B. (1990) Sleep patterns of shift workers, in A.J. Scott (Ed.) *Shiftwork*. Philadelphia: Hanley and Belfus. With permission.)

variables, both social and biological, may simultaneously exhibit carry-over, sum, and thereby increase or decrease overall cumulative health and safety risk.

In summary, it is reasonable to expect that the acute and chronic impact of work shifts may differ and must be evaluated. Obviously, it is also true that very long continuous operations and/or work shifts

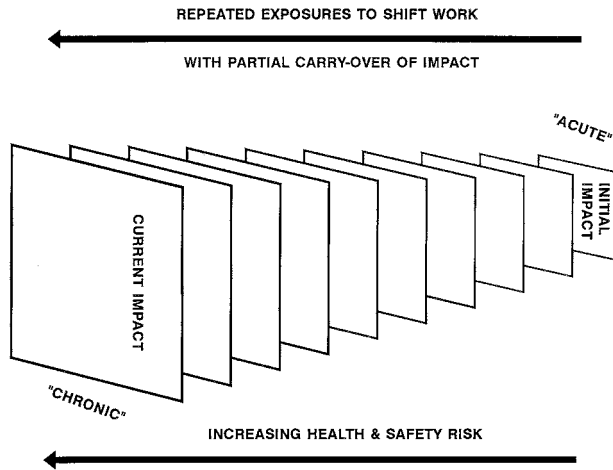

FIGURE 19.6 The work shift carry-over model. Repeated exposure to a shift with partial carry-over increases health and safety risk.

have an acute impact on performance which can terminate or flaw behavior (Kreuger, 1989). In the field, the chronic impact of work shifts may be more difficult to identify, since those who cannot tolerate night work may elect to leave shift work. It has been argued that experienced shift workers should be viewed as a survivor population (Koller, Kundi, and Cervinka, 1978; Tepas, Duchon, and Gersten, 1993).

Work Shift Usability — Summary

Advances in our knowledge of work shift variables during the last 20 years have slowly led to changes in traditional expectations. Early shift work investigators expected that their efforts would identify universal work shift *hazards*, and they assumed that once these hazards were identified they would work on minimizing their use. Most managers, on the other hand, expected that research would provide them with universal *best ways* to achieve maximum shift worker productivity. Both perspectives assumed that in the future they would be able to apply universal limitations or principles in a fairly mechanical way. It is now quite clear that both of these viewpoints were quite naive and incorporated expectations which are neither appropriate nor practical. Unfortunately, many managers and some investigators continue to hold these naive perspectives.

Why are the more traditional approaches wrong? Four developments lead to a change in outlook and the contemporary approach taken in this chapter. *First* is the expansion in our knowledge with regard to the range of complex variables impacting shift worker performance and well-being. This multiple-variable context makes precise prediction and application difficult. *Second*, interaction between these complex variables sometimes reverses the valence sign of a given work shift. That is, a number of evaluation studies have demonstrated that the same work shift may be good in one workplace and bad in another. *Third*, many additional work shift forms have been identified. These are alternative work shifts which have already been used and can be considered for possible application at new sites. Knauth (1997) estimates that worldwide there are over 10,000 different work shift schedules being used. This is probably a conservative underestimation. *Fourth*, the evolution of new manufacturing and scheduling technologies makes the use of some innovative shifts practical or required. In some cases, these are shifts which were previously judged to be impractical or unlikely.

The contemporary approach to work shifts recognizes the developments outlined above. Informed work shift investigators admit that the shift design task may sometimes be more art than science. The search for the ideal work schedule, a suit that fits without tailoring, has ended. Informed managers recognize the complexity of the work shift problem, the importance of the task, and the need for expert help. When informed, both shift experts and managers are working toward shift solutions with objectives

which include improved health, safety, and productivity. Most important, there is a recognition that apparent solutions require objective assessment and evaluation. Work shift usability testing is one approach to achieving these goals.

19.2 Work Shift Assessment

Introduction

Usability testing is not a new approach for the ergonomics professional. It has been used for years with many problems including the design and evaluation of tools, devices, displays, and software. This usability testing refers to the methods used to ascertain the value of a design, not simply an effort to assess the quality or ability of an individual. The user aids in the identification of desirable and undesirable designs, but in most cases does *not* select the final design. Alternative designs are often considered. A fundamental feature of this approach to design is the assumption that *use testing with real users is a required and a fundamental approach* in most cases.

Work shift usability testing retains this fundamental assumption that real users should participate in assessing the value of a design. In addition, it assumes that a macroergonomic approach is needed. That is, one must recognize that work shifts, as well as changing work shifts, do impact and interact with many of the basic ways in which an organization operates. Within this approach, work shift assessment is the first phase of work shift usability testing, and it can be practiced as a three-step process: preliminary assessment, initial assessment, and formal assessment.

Preliminary Assessment

As an introduction to a given work shift usability testing effort, the work shift specialist completes an informal guided walk-through of the complete workplace. Following this first step, the work shift usability testing scenario begins with a *preliminary assessment* of the work shift *perceptions* present in the workplace. This preliminary assessment is often coupled with a general review for users of what experts now know about work shift impact, and a more specific discussion of the methods which might be used by the visiting specialist. When practical, this should be done by presentations and discussions within three meetings: *first*, a meeting with the highest level resident manager; *second*, a meeting with a representative group of middle managers; and *third*, a meeting with local union representatives. If the workers are not represented by organized labor, the *middle* level managers should be asked to supply a worker group which they feel represents all facets of worker opinion and job duties.

For the work shift specialist, the primary purpose of these meetings is to assess whether the culture and customs of the workplace are receptive to the methods required for work shift usability testing. A prudent approach recommends that one *not* commit to doing work shift usability testing until after completing and evaluating the results of the preliminary assessment. Since the users are to be participants in the usability testing, one must assess whether the required methods are feasible and appropriate for the specific workplace under consideration. A secondary goal is to gather some initial preliminary impressions as to what and how these individuals currently perceive their own work shift issues and problems. Finally, these meetings provide the specialist with an opportunity to learn more about the technology, tasks, practices, and limitations of this specific workplace.

Figure 19.7 lists some of the important features, common to quality work shift usability testing, which should be communicated in each of these meetings. These points should be communicated to all parties as the essential features required to assure a state-of-the-art work shift usability testing effort. Obviously, these presentations provide the specialist with a key opportunity to begin to earn the trust of the organization at all levels. Each presentation should clearly communicate to those present what will be required from all parties if work shift usability testing is to be done. It is appropriate to present these features to everyone as requirements, rather than as options which they might select from. Obviously, additional requirements should be added to this list when warranted by local conditions.

**REQUIREMENTS
FOR
WORK SHIFT USABILITY TESTING**

- ✓ **Time: A quality assessment takes time.**
- ✓ **Participation: Universal participation is possible and needed.**
- ✓ **Trust: The Work Shift specialist must be trustworthy and objective.**
- ✓ **Voluntary & Anonymous: Only group data will be revealed.**
- ✓ **Alternatives: All suggestions will be evaluated and more than one alternative solution will probably be made.**
- ✓ **Selection: The Final solution selection is not made by the Work Shift Specialist.**
- ✓ **Solution: The Work Shift Specialist helps install a changes, if it is needed.**
- ✓ **Evaluation: If any changes are installed, they should be evaluated by the Specialist..**

FIGURE 19.7 Some of the important features, common to most work shift usability testing, which should be communicated to potential users in advance.

For those attending these meetings, the work shift specialist also provides a general presentation of the potential benefits of a good work shift design, as well as a general discussion of how bad work shift design can lead to problems. This is followed by the detailed discussion of the *methods* which are used by this work shift usability specialist. Both the presentation and the discussion should be conducted in a manner which invites questions and provides honest answers. Each of the three preliminary assessment meetings should include an overt attempt by the work shift usability testing specialist to determine what those present feel are important issues, likely outcomes, and interest in further participation.

Initial Assessment

Following completion of the preliminary assessment, the *initial assessment* begins. At this point, the work shift usability specialist has not as yet agreed to do work shift usability testing. Using the data gathered during the preliminary assessment, the specialist must now determine if usability testing is practical in this situation and how it should be done. The features listed in Figure 19.7 provide a good outline for this initial assessment by the specialist. User interest, participation, and rights must be assured at all levels within the organization before the specialist proposes to do a complete and professional usability testing.

In some cases, one or more of the features in Figure 19.7 may not be met. Should this be true, the specialist should consider this as a possible and adequate reason for project termination. Alternatively, one or more of these features may be the basis of additional discussions and lead to subsequent change. For example, a manager may indicate that he is simply interested in obtaining a stamp of approval for a new work shift he has already selected on some basis other than discussion with the specialist. In this case, the specialist may be able to broaden the manager's perspective by providing several additional examples of possible alternative work shifts that should be considered.

On ethical grounds, the right to voluntary and anonymous participation should never be negotiated. Given the need for additional data and the potential for error, *evaluation* is another feature which has major merit and should be retained whenever possible. In general, the features listed in Figure 19.7 should

be viewed as *requirements* needed to do quality work shift usability testing. Explanation and discussion is appropriate, when possible, but these points should not be presented as special options which are not needed. When the specialist concludes that work system usability testing is not recommended, a brief written report explaining why these services are not recommended is appropriate.

When work system usability testing appears to be practical, the specialist should attempt to categorize the work shift problems of interest. Since many in the workplace have a rather limited knowledge of work shifts and what we know about them, their initial identification of what they want may or may not be in error. The task of placing the work shift problems into a category often helps clarify *to the users* what they should realistically expect from work shift usability testing. In addition, categorization often promotes user participation, since it may be the first time specific goals have been stated. Given our current knowledge of work shifts, four categories are suggested. These *categories of evaluation* are: acute exposure hazard analysis, chronic exposure hazard analysis, acute exposure schedule change, and chronic exposure schedule change.

Acute exposure hazard analysis. The work shift to be assessed is *not* experienced by an individual on a daily or frequent basis, but many individuals may be exposed to this work shift over time on an actuarial basis. This category includes work shifts which may or may not constitute a threat to the health, safety, and/or performance of workers. The work shift usability specialist is trying to find out if any of these threats exists or is likely. Knowing what the threat or potential threat is may suggest a prophylactic measure or therapeutic method. In some cases it might be a proscriptive work shift which is to be avoided whenever possible. Some likely examples: travelers with many rapid time zone changes (jet lag), sustained emergency medical operations, search and rescue efforts, laboratory shift work studies, and sleep deprivation studies.

Chronic exposure hazard analysis. The work shift is experienced by individuals on a daily or frequent basis. This category includes work shifts which may or may not constitute a threat to the health, safety, and/or performance of the workers. The work shift usability specialist is trying to find out if any threats exist or should be anticipated as a future development. The employer does not have an interest in change, but wants to know the current status of the work shift system. Finding that a threat exists may, of course, suggest that a new work shift is needed. An educational program and/or other benefits may also provide solutions. Some likely examples: any continuous operation, permanent night shift work, workers employed at remote locations, work in a harsh environment, permanent part-time workers, and on-call-when-needed workers.

Acute exposure schedule change. The work shift is *not* experienced by an individual on a daily or frequent basis, but over time many individuals may be exposed to this work shift on an actuarial basis. This category includes work shifts in which the employer wishes to propose a new shift remedy. The need to change can be related to health, safety, performance, legal, and/or economic reasons. The work shift usability specialist is to assess the current status of things and then suggest a remedy. Among the remedies are increasing the number of workers to decrease frequency of exposure, changing the manner in which workers are assigned to these shifts, installation of rules governing frequency of exposure, and an improved work shift design. Examples of this are the same as those given for acute exposure hazard analysis. The difference is that for one reason or another the employer elects to make a work shift system change.

Chronic exposure schedule change. The work shift is experienced by individuals on a daily or frequent basis. This category includes work shifts which the employer thinks need changing due to health, safety, performance, legal, and/or economic reasons. The work shift usability specialist is to assess the current state of things and then suggest work shift changes. In addition to a new work shift design, an educational program and other benefits may also be suggested. Examples of this are the same as those given for chronic exposure hazard analysis. Again, the difference is that for one reason or another the employer elects to explore the possibility of making a work shift system change.

Proposal and schedule. The initial assessment, when additional work is appropriate, concludes with a proposal and schedule for a *formal assessment* and subsequent activities. The content and schedule of this proposal will vary as a function of categorization (above). Obviously, a formal assessment may or may not fully confirm the impressions of the preliminary or the informal assessments. In practice, much of the formal assessment method does *not* vary with categorical assignment. What does vary with categorical assignment is the information and recommendations generated from the subsequent analysis

of the formal assessment data. In a very real way, the proposal should make the objectives and requirements of the process very clear to both employer and user.

When only a *hazard analysis* is requested, a formal assessment is proposed, but no new work shift suggestions are included in the venue. For an *acute* hazard analysis report where a hazard is detected, the employer and users should expect recommendations for a prophylactic preparation or therapeutic treatment via a training program or support services. Managers and users should also be warned in advance that these educational programs and support services, if implemented, will need evaluation since they are largely unproved (Tepas, 1993). For a *chronic* hazard analysis report which identifies the presence of a hazard, neither employer nor participants should be led to expect that a treatment or training program might overcome the problems associated with a bad work shift schedule. An improved work schedule should always be given priority over the installation of a treatment or training program.

When a *schedule change* is requested, a formal assessment is also proposed. The employer and users should be led to expect that more than one new work shift design suggestion will be included within the results of the formal assessment report. They should also be informed that the report will include a plan to evaluate the impact of the new schedule. For an *acute* exposure schedule change, the strategy is to eliminate or minimize the occurrence of a hazard by eliminating or minimizing the use of the hazard-producing shift. Many *chronic* exposure effects (for example, working at night) cannot be eliminated. For these chronic impact cases, the employer and users should expect to be supplied with alternative work shift design recommendations. Each of these alternative work system designs will have both advantages and disadvantages which they will evaluate.

Formal Assessment

A variety of methodological approaches are available for the formal assessment data collection effort. These include the study of personnel and safety records (Colligan, Smith, Hurrell, and Tasto, 1979), laboratory testing and field interviews (Walsh, Gordon, Maltese, McGill, and Tepas, 1979), and questionnaire surveys (Smith, Colligan and Tasto, 1979; Gordon, Tepas, Stock, and Walsh, 1979). With each of these approaches, the objective is to gather representative data about users and their duties in a valid and reliable manner. Each of these methodological approaches has advantages and limitations which are reviewed in these publications. The questionnaire survey approach appears to be the method of choice, since practice shows that nearly all workers respond to these instruments when the requirements listed in Figure 19.7 are met (Tepas, Armstrong, Carlson, Duchon, Gersten, and Lezotte, 1985).

Figure 19.8 provides a listing of some of the more important dimensions which should be included within this formal assessment. The order in which these dimensions are listed is not significant, and this is not an exhaustive listing. It is recommended that the actual variables used with any of these approaches be developed in an *iterative* process within small group meetings of the work shift specialist with managers and users. This iterative process promotes progress toward three goals. First, it helps confirm the specialist's status as an independent third-party *expert* who values participation and confidentiality. Second, it is one way of making sure that the assessment examines all variables relevant to the workplace being assessed. Third, the review of items with users assures that the vocabulary level and technical terminology used in the survey match the ability of the user and local workplace term usage.

Although the selection of items for this formal analysis is participatory and iterative, it must be tempered by using standard and proven items whenever possible. There are two major reasons for this. First, it often allows one to assume item validity generalization on the basis of previous findings. Second, collecting quantitative data in a standard way allows one to directly compare the data from one workplace to those gathered in another. Using standard items on the survey provides the specialist with access to the benchmarks needed to evaluate the data collected.

Experience with the sleep length variable provides a good example of why validity, reliability, and benchmarks are needed. All of the sleep length data presented earlier in this chapter are subjective data gathered by asking the same standard questions every time. Sleep length was calculated from times produced by workers when they were asked when they usually go to bed and get up. These times are



**DIMENSIONS
FOR
WORKER ASSESSMENT**

- **Demographic reports of age and gender**
- **Usual work, work hours and overtime**
- **Sleep, fatigue and stress reports**
- **Eating behavior and appetite**
- **Drug, alcohol and tobacco use**
- **Medical problems and treatment**
- **Marital, family and household status**
- **Work schedule history and preferences**
- **Non-workplace activities and preferences**

FIGURE 19.8 Some of the more important dimensions which should be included within the formal user assessment.

significantly and highly correlated with polysomnographic, log, and interview estimates of sleep length (Tepas, Walsh, and Armstrong, (1981). However, simply asking workers how many hours they usually sleep often fails to yield valid estimates. It is not surprising to learn that some investigators (for example, Frese and Harwich, 1984) have had trouble relating their measure of sleep length to shift schedule differences.

As noted earlier, the major goal of formal assessment is the production of representative quantitative data. These data aid the work shift usability specialist in designing appropriate alternative work schedules, and supporting their use. Sometimes managers or users attribute additional goals to this effort. For example, the term “testing” leads users to conclude that this assessment is a competitive evaluation or examination which they can pass or fail. Other users conclude that the assessment is an election wherein they are voting for or against some work shift schedule. Neither of these attributions is correct or helpful, and overt efforts to minimize their face validity are warranted.

Whether the task at hand is limited to the evaluation of a practiced work shift design or it also includes the design of a new work shift system, Figure 19.9 provides a listing of some of the basic options which a work shift usability specialist should consider when designing a new work shift system. This listing is not exhaustive and the order of the variable listing is not significant. Given the fact that these options can combine to form thousands of different work shift systems, the suggestion that the design process be performed by a specialist is appropriate. Similar to many ergonomic design problems, several work shift designs will appear to be reasonable proposals.

When the category of evaluation is schedule change, the work shift usability specialist will usually produce a written *work shift assessment report* which includes several design alternatives that merit workplace assessment. This written report to managers and users should make an overt effort to link the designs recommended to the objective data collected in the workplace under study. It should also relate the data collected in this workplace to other similar databases. The advantages and disadvantages of each work shift design proposal should be stated in a manner which will ensure that all of the suggested design alternatives are given a full workplace assessment.

19.3 Workplace Assessment

Introduction

When testing software for usability, the human factors specialist knows that some changes he might recommend will *not* be accepted because they are too costly. The work shift usability specialist faces

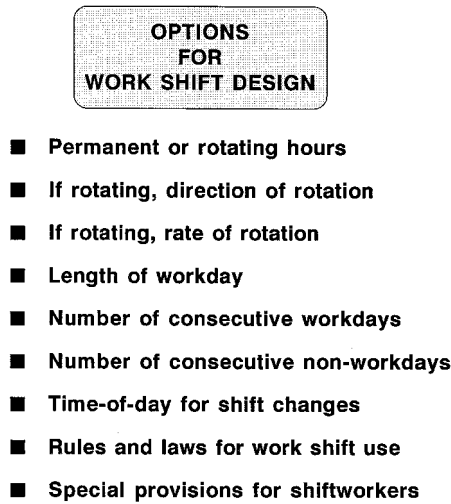

FIGURE 19.9 Some of the more important options which should be considered in designing work shift systems.

similar and even more complex problems when testing the usability of a work shift. Every work shift has both a long-term and an immediate monetary cost associated with implementation and use. Some work shift designs are simply not as cost-effective as other designs. Historically, there is reason to suggest that work shift changes were often introduced without taking the time to do a comprehensive workplace assessment. Improved work shift systems can significantly reduce costs, but there are many hazards which must be avoided by good planning, if these changes are to be profitable.

For example, the introduction of a continuous work shift may require an inventory increase due to a failure to consider receiving and shipping limitations. Also, the work shift system may require equipment maintenance down-time that makes it too expensive since it would require additional capital equipment investment. User work shift preferences may evoke many complex long-term and immediate costs. For example, overtime payments required by law might make some workdays or workweek features too expensive. Also, the chronic toxic substance exposure levels of an extended workday or workweek might increase sickness or increase physical agent carry-over to harmful levels. Many additional examples are possible.

Work Shift System Selection

Just as work shift assessment and recommendations require the services of a work shift usability specialist, the final selection of a work shift for use in a specific workplace requires special skills. A diverse management team is required, and this methodology may be appropriate even when the category of evaluation is one of hazard analysis rather than schedule change. When possible, this team should include the work shift usability specialist, appropriate managers, and representative users. This is the *workplace assessment team*. The initial task of this team is the completion of a *workplace assessment report* to complement the work shift assessment report prepared (alone) by the work shift usability specialist.

Using a systems approach, the workplace assessment team evaluates the work shift designs recommended (or the existing work shift system) by the work shift usability specialist. Figure 19.10 provides a listing of system dimensions which should be reviewed by the team as it completes the workplace assessment. This listing should not be regarded as either an exclusive or an all-inclusive list. An early task of the team should be a review of these dimensions to decide if any dimensions should be removed or added to their assessment task. A review of the list should make it clear that many of these items require special expertise outside the purview of the work shift usability specialist.

**DIMENSIONS
FOR
WORKPLACE ASSESSMENT**

- ▶ **Community and organization shiftwork history**
- ▶ **Health, safety and legal issues and records**
- ▶ **Present and future demand for product/services**
- ▶ **Present and future job market status**
- ▶ **Maintenance and support service requirements**
- ▶ **Utility, shipping and receiving costs/problems**
- ▶ **Supervision and manpower requirements**
- ▶ **Personnel data collection and analysis methods**
- ▶ **Measurement and use of productivity indicants**

FIGURE 19.10 Some dimensions which should be reviewed by the workplace assessment team when evaluating alternative work shift designs.

The methods and product of the workplace assessment will vary from workplace to workplace, molded to a considerable degree by the characteristics of the organization and the category of evaluation. Four alternative goals should be considered in each case: (1) a recommendation that the present work shift system continue to be used; (2) a change in work shift is in order, and the work shift specialist should offer some designs; (3) a recommendation that one of the alternative work shift designs offered be implemented; and (4) a recommendation that none of the alternatives presented is acceptable, but change is needed and additional alternatives should be examined.

19.4 Work Shift Implementation

When workplace assessment leads to the installation of a new work shift system, an *implementation plan* should be developed and put into practice. In many cases, this is done by the workplace assessment team which now becomes the *implementation team*. In any case, the work shift usability specialist should be an active participant in the development and practice of the implementation plan. Often, eagerness to try a new work shift system results in implementation without planning. This is not recommended.

The implementation team has four primary goals. First, a communication to all users which clearly states the rationale for selecting their work shift system, the rules which will govern work shift operation, and how the system will be evaluated. Second, the development of a training program for users which will instruct them about their individual work schedule and what they might do to improve their ability to cope with it. It is often beneficial to include spouses in this training program, and to involve users in an evaluation of the training program. Third, the development of a plan to install any administrative or physical changes in the workplace is required for the new work shift system to become fully operational. Fourth, the design of a plan to evaluate the impact of the new work shift system.

Designing a research plan for the evaluation of a change, prior to the actual implementation of the new work shift system, serves several purposes. As a workplace announcement, the evaluation plan makes it clear to users that evaluation of a new system will take time, requires a significant test period, and assures that faults will draw attention. In addition, designing evaluation in advance makes it more likely that appropriate data are collected and methodological pitfalls are avoided. The research plan should be designed to evaluate both the acute and chronic effects of the work shift system installed on worker productivity, safety, and health.

19.5 Summary

Work shift usability testing is a macroergonomic process aimed at the design, installation, and evaluation of work shifts and shift systems. Today, multiple variables affect people and are associated with the use of thousands of different work shifts. Work shift usability testing involves work shift assessment, workplace assessment, and the assessment of work shift interventions when they are made. Recognizing the complexity of the ergonomic problem, the approach recommends the employment of a third-party independent specialist. The methods outlined apply to a wide range of work shift applications using actuarial prediction.

Whenever possible, work shift usability testing should be a participatory process involving real users. Research during the last decade or so makes it quite clear that work hours have both acute *and* chronic impacts on the safety, health, happiness, and productivity of work shift users. Since the paradigm addresses both acute and chronic changes, it can also be used to address unique problems such as those traditionally associated with hours of service issues or emergency service. Given the fact that humans are diurnal animals with biological clocks which are difficult to reset, the mastery of time is a difficult task. The realities of an international market and global organizations suggests that the mastery of around-the-clock operations may be the ultimate challenge of the new technological workplace.

The work shift usability testing model outlined has been applied to a wide range of situations and industries. For example, the same general approach can be applied to commercial transportation workers (Tepas, Popkin, and Dekker, 1990), traditional factory workers (Tepas, 1993), and workers on sustained operations (Carvalhais, Tepas, and Paley, 1994). In each case, the impact of work schedules is complex and the variety of work hour solutions is immense. The merits and limitations of this approach must be tested, and they will be most evident when the work shift usability testing includes a good evaluation research plan.

References

- Carvalhais, A.B., Tepas, D.I., and Paley, M.J. (1994) An evaluation of a coast guard "live-aboard" concept: Can crews adapt to a restricted living and operational environment? *Proceedings of the Human Factors and Ergonomics Society 38th Annual Meeting*, 873-877.
- Cole, R.J., Loving, R.T., and Kripke, D.F. (1990) Psychiatric aspects of shift work, in A.J. Scott (Ed.) *Shiftwork*. Philadelphia: Hanley and Belfus.
- Colligan, M.J., Smith, M.J., Hurrell, J.J., and Tasto, D.L. (1979) Shift work: a record study approach. *Behavior Research Methods and Instrumentation*, 11, 5-8.
- Dekker, D.K. and Tepas, D.I. (1990) Gender differences in permanent shift work sleep behavior, in G. Costa, G. Cesanna, K. Kogi, and A. Wedderburn (Eds.) *Shiftwork: Health, Sleep and Performance*. Frankfurt-am-Main: Peter Lang.
- Dekker, D.K., Tepas, D.I., and Colligan, M.J. (1996) The human factors aspects of shift work, in A. Bhattacharya and J.D. McGlothlin (Eds.) *Occupational Ergonomics: Theory and Applications*. New York: Marcel Dekker.
- Frese, M. and Harwich, C. (1984) Shift work and the length and quality of sleep. *Journal of Occupational Medicine*, 26, 561-566.
- Gersten, A.H. (1987) *Adaptation in Rotating Shift Workers: A Six Year Follow-Up Study*. Unpublished doctoral dissertation. Illinois Institute of Technology, Chicago.
- Gordon, G.C., Tepas, D.I., Stock, C.G., and Walsh, J.R. (1979) Gaining access to shift workers through labor unions. *Behavior Research Methods and Instrumentation*, 11, 14-17.
- Harma, M., Seitsamo, J., and Ilmarinen, J. (1997) Shift work, aging and health: an 11-year follow-up study of nurses. *Shiftwork International Newsletter*, 14 (1), 127.
- Howarth, H., Pratt, J., and Tepas D. (1997) Maritime search and rescue crew member reports of sleep duration and related problems. *Shiftwork International Newsletter*, 14 (1), 82.

- Kawachi, I., Colditz, G.A., Stampfer, M.J., Willett, W.C., Manson, J.E., Speizer, F.E., and Hennekens, C.H. (1995) Prospective study of shift work and risk of coronary heart disease in women. *Circulation*, 92, 3178-3182.
- Knauth, P. (1997) Innovative working times. *Shiftwork International Newsletter*, 14 (1), 2.
- Knutsson, A. (1989) Shift work and coronary heart disease. *Scandinavian Journal of Social Medicine*, Supplementum 44.
- Koller, M., Kundi, M., and Cervinka, R. (1978) Field studies of shift work in an Austrian oil refinery I: Health and psychosocial wellbeing of workers who drop out of shift work. *Ergonomics*, 21, 835-847.
- Krueger, G.P. (1989) Sustained work, fatigue, sleep loss and performance: A review of the issues. *Work and Stress*, 3, 129-141.
- Mahan, R.P., Carvalhais, A.B., and Queen, S.E. (1990) Sleep reduction in night-shift workers: Is it sleep deprivation or a sleep disturbance disorder? *Perceptual and Motor Skills*, 70, 723-730.
- Mahan, R.P., Tepas, D.I., and Carvalhais, A.B. (1987) Morningness-eveningness norms for industrial shift workers, in A. Oginski, J. Pokorski, and J. Rutenfranz (Eds.). *Contemporary Advances in Shiftwork Research: Theoretical and Practical Aspects in the Late Eighties*. Krakow: Medical Academy.
- Mitler, M.M., Carskadon, M.S., Czeisler, C.A., Dement, W., Dinges, D.F., and Graeber, R.C. (1988) Catastrophes, sleep, and public policy: consensus report. *Sleep*, 11, 100-109.
- Monk, T.H. (1989) Social factors can outweigh biological ones in determining night shift safety. *Human Factors*, 31, 721-724.
- Paley, M.J. and Tepas, D.I. (1994) The effect of tenure on fire fighter adjustment to shift work. Paper presented at the 23rd International Congress of Applied Psychology, Madrid, Spain.
- Presser, J.B. (1995) Job, family and gender: Determinants of nonstandard work schedules among employed Americans in 1991. *Demography*, 32, 577-598.
- Radosevic-Vidacek, B., Vidacek, S., Kaliterna, L., and Prizmic, Z. (1995) Sleep and napping in young shift workers: A 5-year follow-up. *Work and Stress*, 9, 272-280.
- Smith, M.J., Colligan, M.J., and Tasto, D.L. (1979) A questionnaire survey approach to the study of the psychosocial consequences of shift work. *Behavioral Research Methods and Instrumentation*, 11, 9-13.
- Steinberg, R. (1982) *Wages and Hours: Labor and Reform in Twentieth-Century America*. New Brunswick, New Jersey: Rutgers University Press.
- Tepas, D.I. (1982) Work/sleep time schedules and performance, in W.B. Webb (Ed.) *Biological Rhythms, Sleep, and Performance*. New York: John Wiley & Sons.
- Tepas, D.I. (1985) Flextime, compressed workweeks and other alternative work schedules, in S. Folkard and T.H. Monk (Eds.) *Hours of Work*. New York: John Wiley & Sons. pp. 147-164.
- Tepas, D.I. (1993) Educational programs for shift workers, their families, and prospective shift workers. *Ergonomics*, 36, 199-209.
- Tepas, D.I. (1994) Technological innovation and the management of alertness and fatigue in the workplace. *Human Performance*, 7, 165-180.
- Tepas, D.I. and Carvalhais, A.B. (1990) Sleep patterns of shift workers, in A.J. Scott (Ed.) *Shiftwork*. Philadelphia: Hanley and Belfus.
- Tepas, D.I. and Mahan, R.P. (1989) The many meanings of sleep. *Work and Stress*, 3, 93-102.
- Tepas, D.I., Duchon, J.C., and Gersten, A.H. (1993) Shift work and the older worker. *Experimental Aging Research*, 19, 295-320.
- Tepas, D.I., Paley, M.J., and Popkin, S.M. (1997) Work schedules and sustained performance, in G. Salvendy (Ed.) *Handbook of Human Factors and Ergonomics, Second Edition*. New York: John Wiley & Sons.
- Tepas, D.I., Popkin, S., and Dekker, D. (1990) A survey of locomotive engineers on irregular schedules and their spouses: A preliminary report, in G. Costa, G.C. Cesanna, K. Kogi, and A. Wedderburn (Eds.) *Shiftwork: Health, Sleep and Performance*. Frankfurt-am-Main: Verlag Peter Lang.

- Tepas, D.I., Walsh, J.K., and Armstrong, D.R. (1981) Comprehensive study of the sleep of shift workers, in Johnson, L.C., Tepas, D.I., Colquhoun, W.P., and Colligan, M.J. (Eds.) *Biological Rhythms, Sleep and Shift Work*. New York: SP Medical and Scientific Books.
- Tepas, D.I., Armstrong, D.R., Carlson, M.L., Duchon, J.C., Gersten, A., and Lezotte, D.V. (1985) Changing industry to continuous operations: different strokes for different plants. *Behavior Research Methods, Instruments, and Computers*, 17, 670-676.
- Walsh, J.R., Gordon, G.C., Maltese, J.W., McGill, W.L., and Tepas, D.I. (1979) Laboratory and field interview methods for the study of shift workers. *Behavior Research Methods and Instrumentation*, 11, 18-23.

Part III
Ergonomics and the
Working Environment

Section I
The Office Environment

20

Ergonomics of Seating and Chairs

20.1	Introduction	20-1
20.2	Fundamentals	20-2
	System Goals in Seated Posture (Functional Purpose) • Priority-Defining Constraints and Mechanisms (Abstract Function) • Statement of the Problem • Functional Requirements in Chair Design (General Function)	
20.3	Envelope of Postural Orientations.....	20-4
20.4	Biomechanical Efficiency Assumption	20-4
	Unsupported Seated Posture • Spine and Discs • Muscles and Internal Organs • Pressure on Thighs and Buttocks and Lower Legs	
20.5	Design Specifications	20-6
20.6	Multiple-Degrees-of-Freedom Problem Spaces	20-6
20.7	Applications and Examples	20-7
	Individual Chair Components • System Integration: The Ecology of Seated Posture	
20.8	Discussion.....	20-15

Marvin J. Dainoff
Miami University

20.1 Introduction

In seated posture, the chair is, by definition, critical. For any work situation in which sitting is involved, the chair represents the primary support system which puts the user in contact with the workstation. This support function is even more important for those tasks, increasingly characteristic of modern workplaces, which require precise coupling of hands and tools and high degrees of visual attention for prolonged periods of time. A large proportion of such tasks, of course, include those involving video display terminals.

Designing effective seating is not a trivial problem. Eminent designers have attested to the problems of chair design. Frank Lloyd Wright complained that: "...all my life my legs have been banged up somewhere by the chairs I designed." Mies van der Rohe asserted that: "...a skyscraper seemed almost easier to design than a chair" (quoted in Stewart, 1987). The issues in chair design have often reflected competing interests and agendas, in which aesthetic and status considerations have often overpowered functionality. As a case in point, the famous Barcelona chair — designed for a 20-second seated appearance by the King of Spain—has had a major impact on the design community, although it is functionally better fitted to look at rather than sit in (Stewart, 1987; Pheasant, 1986). There is no inherent reason why functionality, aesthetics, and cost must inevitably conflict, but such conflicts have, unfortunately, been common. Perhaps part of the problem has been that there has been no coherent or integrated statement of the functional and physiological requirements for seated posture arising from an applied

science (ergonomic) framework. Accordingly, individual chair designers have been required to create their own theoretical model of the seated user, incorporating intuitive concepts of both anatomical structure and user behavior into their designs. The goal of this chapter is to provide an organizing framework within which to discuss critical ergonomic issues applicable to both designers and customers.

Since the end of the 19th century, sitting in erect postures has, at least in Western societies, been considered both socially acceptable and biologically healthful (Zacharkow, 1988; Kroemer et al., 1994). *Erect posture* refers to a situation in which the head, trunk, and lower legs are vertical, and the upper legs and arms horizontal. This posture has been nicknamed the “cubist” work posture, since it is rather easy to describe with a series of right angles (Mark and Dainoff, 1988). Prior to the early 1980s, most ergonomic recommendations for “task” chairs (appropriate to office or industrial work) utilized a cubist model. A state of the art ergonomic task chair was one that had height adjustability of the seatpan, a rounded forward edge of the seatpan, and possibly some lumbar support.

However, with the advent of large-scale office automation, and the associated rise of musculoskeletal complaints among office workers, a greater degree of attention began to be focused on the functional requirements of seating (Dainoff and Dainoff, 1986). In particular, the cubist assumption was challenged. Grandjean et al. (1983) called the upright posture “wishful thinking,” and indicated that the natural working posture would be one in which an adjustable backrest allowed the trunk to be inclined rearward. Mandal (1981, 1986), on the other hand, argued that efficient working posture required the trunk to be upright, but this could be achieved efficiently if the seatpan were sloped forward. Dainoff and Mark (1986) argued that both postures had their advantages, depending on the demands of the task. In fact, chairs which could allow both the Mandal and the Grandjean postures started to become available in the marketplace during the middle and late 1980s, and are now commonplace.

As additional research continues to emerge, however, it is clear that there is much left to understand about seated posture and chair design. Grieco’s (1986) review paper indicated that static models of seated posture — involving specification of optimal postures for given tasks—were inadequate, and that movement itself was a primary requirement in seated work. Consequently, there continues to be active investigation involving issues relating to the dynamics of seated posture. These include examination of the relationships between seatpan and backrest angles adjustability, and the nature and extent of user adjustability.

The materials which follow cannot, at this stage, reflect a fully developed set of principles and recommendations. Rather, they will complement other material by reviewing the underlying ergonomic issues and concerns which must be addressed by designers of chairs, as well as designers and users of the work environments within which the chairs are incorporated. While much of the focus will be on office workplaces, many of the same issues apply to industrial workplaces, and these will be addressed where appropriate.

20.2 Fundamentals

Ergonomics can be described as the fit between people and the elements of the physical environment with which they interact (Dainoff and Dainoff, 1986). As such, ergonomics is inherently relationship-oriented in that absolute dimensions and physical characteristics of objects in the work environment must be defined relative to the relevant characteristics of the user. The ecological perspective of J.J. Gibson (1979) provides a principled approach to conceptualizing such relationships.

A key element in this approach involves the terms *affordance* and *effectivity*. Affordances refer to the characteristics of the physical environment measured with respect to the individual or “actor.” Affordances thus represent, in physical terms, the potential for action afforded by the environment for a particular individual. Effectivities are complementary in that they refer to action capabilities of individuals measured with respect to the physical environment. In the case of seating, for example, an ordinary office chair (physical object) affords sitting (action) for an adult but not a typical two-year-old child. The adult and child differ in their effectivities (action capabilities) because of their different sizes.

In order to carry out goal-directed actions in the world, the individual actor must be able to perceive the affordances of that world. (A 250-lb. adult will most likely not choose to sit in a chair made for a two year old!) However, most real-world work environments consist of collections of affordances, some of which may be nested within others. To meet the challenge of characterizing such environments — to allow perception of complex sets of affordances by the user/actor — Vicente and Rasmussen (1990) have utilized a conceptual tool called the *means–end abstraction hierarchy*. Central to this concept is the notion that groups of affordances can be hierarchically organized by function. At any point in the hierarchy, the affordances at one level act as the ends or goals with respect to the affordances (means) at the next level down.

The rest of the material in this chapter will be, to some extent, organized as a means–end abstraction hierarchy. The first three sections under Fundamentals will include the three highest levels of the hierarchy. The remaining sections, under Applications, and Examples will consist of the lower levels. The relationships between levels will be addressed as they occur.

System Goals in Seated Posture (Functional Purpose)

The highest level in the hierarchy reflects the overall goals or functional purpose of the system. Branton's seminal 1976 paper conceptualized seated posture as homeostatic in nature involving two complementary demands: the need for structural support in order to provide stability for the body and the need to dissipate fatigue resulting from the effects of prolonged compression of body tissues against the chair surfaces. Thus, *stability* and *movement* can be considered overall goals of seated posture.

This assumes that seated posture is, in fact, appropriate for a given work task. This may be obvious in office work, but is more problematic in industrial settings. (See Kroemer et al. ([1994, p. 365] and Helander [1995, Ch. 6] for decision criteria for choosing situations in which sitting rather than standing is appropriate.)

Priority-Defining Constraints and Mechanisms (Abstract Function)

The abstract function level of the hierarchy describes the underlying conceptual and scientific framework within which the overall system goals can be achieved. This framework includes proposed postural mechanisms which are subject to certain constraints which, in turn, provide a method for prioritizing chair design decisions.

Statement of the Problem

The human body can be considered a biomechanical system with multiple degrees of freedom. That is, in principle, each muscle–joint combination can be independently controlled by the brain–nervous system, resulting in a virtually infinite number of body postures. Each such posture represents an equilibrium state (balance of internal, applied, and reactive forces) acting against the force of gravity. In practice, this large number of degrees of freedom is greatly reduced by a series of constraints. These constraints can be categorized as follows.

Task Constraints

The demands of each individual task will naturally specify certain postural requirements. For example, a data entry task requires that the fingers be in operational contact with a keyboard and that the copy and screen should be within the central field of vision. These task constraints significantly reduce the number of possible postural orientations and are of great importance in determining functional requirements for chairs.

Environmental Constraints

The number of possible postural orientations is further reduced by the design limitations of the objects, tools, or furniture within the environment with which the user must interact. For an office environment, for example, the linear and angular dimensions, geometrical configuration, and degree of adjustability

of chair, worksurfaces, keyboards, etc., constrain operating postures. In the case of data entry, for example, a standing workstation (e.g. airline reservation desk) allows a rather limited range of postural variations (slumping, bending, moving the legs). On the other hand, nonadjustable chairs and workstations will allow a different but also limited range of postural shifts. Reach envelopes, defining the three-dimensional space which can be easily reached by the seated worker without bending, are a key component.

Human Constraints

Each of the above sets of constraints can be considered affordances. However, the individual user's effectivities — those personal characteristics, preferences, and abilities of each individual — will finally determine the postures which can be seen in the workplace. These characteristics can be divided into two categories:

Physical: includes anthropometric dimensions, strength, and range of limb motion (relevant to operating controls), and somatic/physiological status (e.g., physical disability).

Psychological: includes awareness of body posture, state of discomfort, willingness to shift body positions, and, in particular, knowledge of how adjustability controls of ergonomic furniture work and knowledge of why they should be used. Finally, the question of operator intentionality is crucial; knowledge of how and why must be combined with motivation to act if the controls are to be used effectively.

Functional Requirements in Chair Design (General Function)

Moving down the hierarchy, the conceptual framework described above becomes, in turn, a set of goals or ends for which the means are described at the general function level. Within this framework, the problem of ergonomic design of workspaces can, broadly stated, be conceptualized as the design/organization/arrangement of environmental constraints in such a way as to ensure that the fit between person and components of work environment is optimal. What follows represents a conceptual basis for attaining person–environment fit.

20.3 Envelope of Postural Orientations

Once the set of tasks is defined, we can define an envelope of permissible postural orientations. The basic criterion implicit in specifying a given postural orientation as permissible is that it minimizes biomechanical load on the musculoskeletal system. At the same time, it must be emphasized that static biomechanical models are only a first approximation. A more realistic analysis would view the human operator from the perspective of a complex biological adaptive control system. The act of changing postural orientation should be viewed as an optimization strategy involving the search for zones of biomechanical equilibrium, in which biomechanical load is temporarily minimized (cf. Nubar and Contini, 1961). From the operator's perspective, these may be considered zones of perceived comfort.

Practically, this translates to a concern for shifting among multiple working postures, as well as consideration of rest breaks, task duration, and other temporal issues. It is recognized that in some cases there may be conflicting constraints. For example, data entry work requires tight coupling between fingers and keyboard and eye and copy. Consequently, requirements for postural stability — demanded by the task — may preclude frequent postural shifts (cf. Branton, 1976; Mark et al., 1991).

20.4 Biomechanical Efficiency Assumption

It is assumed that reducing load will result in increased biomechanical efficiency. Biomechanical efficiency will, in turn, lead to: (a) reduced muscular fatigue; (b) decreased perception of discomfort/pain; (c) improved work performance. A further assumption is that symptoms of perceived discomfort/pain can be precursors of musculoskeletal disorders. Finally, comfort is conceptualized as the relative absence of discomfort/pain.

There is a scientific literature related to biomechanical factors which impact musculoskeletal load during sitting. This material is reviewed in Kroemer et al. (1994, pp. 429-498) and Chaffin and Andersson (1991, Ch. 9). See also Zacharkow (1988). Grieco's (1986) review of the epidemiological literature on musculoskeletal disorders comments that:

...nearly all authors have shown a relationship between prolonged sitting posture and disturbances of the osteo-articular apparatus that was statistically significant compared with control groups....

It must be emphasized, however, that there is no agreed-upon unified definition of biomechanical efficiency. Such a definition would imply that not only are the individual underlying mechanisms well understood, but that the ways in which they interact are equally understood, allowing an integrated approach to biomechanical efficiency through optimization. We are far from this understanding (Kroemer et al., 1994, pp. 346). Nevertheless, the concept of biomechanical efficiency can serve as a useful theoretical concept in attempting to understand the literature. (Lederman, 1993, has made a similar argument in the realm of particle physics.)

What follows will be a brief overview of these factors. This overview will be based on Kroemer et al. (1994, pp. 429-498), Chaffin and Andersson (1991, Ch. 9), and Grieco (1986). Citations of individual studies will not be attempted.

Unsupported Seated Posture

Imagine sitting in a doctor's office on the very edge of an examining table. Your feet are hanging freely; there is no back support. The entire body is supported by the ischial tuberosities (which can be thought of as a pair of inverted pyramids) plus a small amount of thigh surface. This posture is, in fact, unstable, and one tends to rock either forward or backward. Stability can be achieved by holding on to the side of the table, or by shifting one's weight backward to increase the surface area. A natural tendency is to slump forward a bit, which has the effect of lowering the center of gravity.

Spine and Discs

When the body is standing erect, the spine — which is composed of bony vertebrae and flexible discs — takes on a characteristic S curve. The lower (lumbar) region of the spine is concave inward and the pelvis is angled forward. This inward posture is called *lordosis*. Upon sitting on a flat seat, the pelvis rotates backward on the ischial tuberosities, and the lordotic curve tends to flatten or reverse into a *kyphosis* (outward concavity.) This kyphotic tendency is enhanced when the trunk slumps forward and the arms are unsupported. Large increases in disc pressures have been observed in such postures. On the other hand, if an inclined backrest is provided and the trunk can be angled backward opening up the thigh-trunk angle, disc pressure is greatly decreased. Figure 20.1 illustrates examples of lordotic and kyphotic postures. Please note that the chair characteristics illustrated are not meant to characterize recommended or nonrecommended chair features.

Additionally, nutrients are provided to the disc via osmotic pressure which can only occur when the discs are alternately loaded and unloaded. Hence, there can be deleterious effects on disc metabolism regardless of postural load, if the sitter does not move periodically.

Muscles and Internal Organs

Prolonged muscle contraction along with maintaining an awkward unsupported sitting posture may result in reduced blood flow and consequent local degeneration of muscle tissue. This may be a particular problem in neck and shoulder muscles during certain seated tasks. On the other hand, electrical activity in muscles has been shown to decrease when the trunk-thigh angle is opened up, as when leaning against a backrest. Results from a variety of sources including studies of astronauts in weightless conditions seem to indicate that optimum (or neutral) posture appears to occur at 120 degrees.

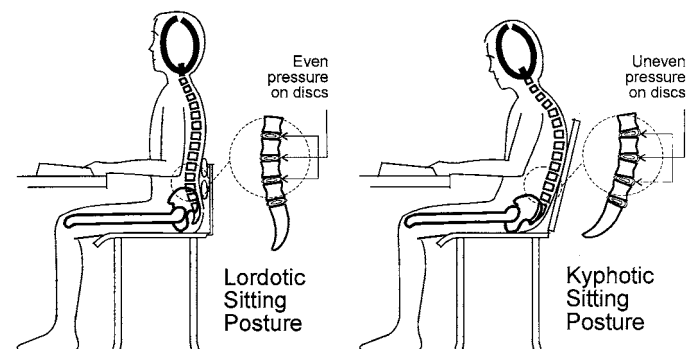

FIGURE 20.1 Illustrations of lordotic and kyphotic sitting postures. Chair features are illustrative only, and do not reflect necessary associations between features and postures.

When the trunk–thigh angle is less than 90 degrees, pressure on internal organs of the body is increased.

Pressure on Thighs and Buttocks and Lower Legs

Local pressure gradients on thighs and buttocks which are too steep can result in impaired blood flow to these regions and to the lower legs as well. This can occur from the edge of a seatpan which is not rounded. The effect is increased if the seatpan is too high (in which case the weight of the leg pulls the underside of the thigh against the edge of the seat) or too low (in which case the region of the buttocks in contact with the seatpan is reduced — thereby increasing the pressure gradient).

20.5 Design Specifications

Specific design specifications of workstation components and arrangements can be attained by combining the envelope of permissible postures, and set of task constraints (affordances) determined above, with a set of specific individual physical constraints (effectivities) while attempting to optimize biomechanical efficiency. Design constraints are specified by a given percentile range (e.g., 5th to 95th) of appropriate anthropometric dimensions for an appropriate user population. If the user population includes individuals with disabilities, additional design constraints are required. The outcome will be a set of workplace dimensions (constraints) which allow individuals within this population range to attain the specified permissible postures.

Chair specifications form a critical component of the workplace. In line with the overall system goals, the chair will afford both stability and the opportunity for movement. These goals appear to be most easily met when the trunk–thigh angle approaches 120 degrees — the so-called neutral posture. Opening this angle can be achieved by either inclining the trunk backward or by keeping the trunk erect and sloping the seatpan forward.

20.6 Multiple-Degrees-of-Freedom Problem Spaces

The art of designing/integrating workspaces, and of designing the seating and other furniture which populate such workplaces, requires that the multiple sets of constraints must be satisfied. However, the operator must also deal with a multidimensional problem space — albeit on an individual scale. To the extent that required adaptability and flexibility is attained by adjustable workplace dimensions, the operator must cope with a multiple-degrees-of-freedom control. A fully adjustable workstation and chair may have upwards of 10 different controls or adjustments which must be coordinated (see Dainoff and

Mark, 1989). Hence, issues of control mechanisms and relationships (e.g., articulation between seatpan and backrest) ought to have the same consideration as biomechanical concerns in the design solution. At the same time, training requirements must go beyond mere lists of simple adjustment procedures to provide the operator with a more conceptual and functional understanding of the overall problem space within which she/he is operating (Rasmussen et al., 1995; Vicente and Rasmussen, 1990).

20.7 Applications and Examples

The remaining sections of this chapter will address the means by which the general functional ends are achieved. The functional requirements described above must now be translated into specific hardware requirements for office furniture. As above, this discussion will focus on issues rather than prescriptions. Where appropriate, reference to ANSI-HFES 100/1988, The American National Standard for Human Factors Engineering of Video Display Workstations will be made. However, this standard is currently in the process of revision. In this revision, a more recent anthropometric survey of U.S. Army personnel (Gordon et al., 1988) was utilized; thus, numerical values for some of the design specifications are likely to differ from the 1988. Moreover, the methods of application of anthropometric data to design specifications are themselves under review. In particular, when two or more anthropometric dimensions must be combined to provide such specifications (as is the case for seatpan height), it is inappropriate to simply add 5th or 95th percentile values of such dimensions (Robinette and McConville, 1981; Zehner, Meindl, and Hudson, 1993; Nemeth and Dainoff, 1997). Thus, specifications based on such combinations should be considered tentative. This is an area of currently active investigation.

Individual Chair Components

Backrest and Lumbar Support

Traditional task chairs for secretaries and clerks have tended to be little more than upright support pads for the lumbar region of the back. These designs seem to have been predicated on the assumption of a 90 degree (cubist) work posture. A more functional backrest will support a greater area of the trunk while inclined backward.

The role of the lumbar support is more problematic. It has typically been assumed that providing a padded surface in the lumbar region will function to restore the lumbar lordosis while the trunk is erect. However, this assumption requires that the trunk remain in close contact with the lumbar pad, and that the pad is properly adjusted so it is, in fact, adjacent to the user's lumbar spine (see Corlett and Eklund, 1984). Hence, the lumbar pad must be height adjustable — either independently, or as part of an adjustable backrest to accommodate anthropometric variability in lumbar height. The only data currently available are those of Branton (1984), from a sample of British railway workers. Computing the lumbar heights of 5th percentile females and 95th percentile males, from means and standard deviations, yields a range of 2.2 to 37.3 cm above seatpan height.

However, there is a variety of approaches to providing padding (or the lack of padding) in the lumbar region of the chair, including a concavity along the vertical axis of the backrest. There is no evidence for the relative effectiveness of these different approaches. In fact, experimental investigations by Bendix et al. (1996) question the basic assumption that such backrests restore lumbar lordosis.

A wide backrest may interfere with tasks which require lateral movement of arms and shoulders. Thus, the possibility of a narrower backrest which still provides vertical support to the trunk should be considered.

Seatpan

ANSI-HFES 100/1988 specifies that the depth of the seatpan be between 38 and 43 cm. This is based on the anthropometric dimension buttock–popliteal length. It is recognized that a seatpan which is too long for a small person (e.g., 5th percentile female) would interfere with seated posture, whereas a seatpan which is too short for a large person (e.g., 95th percentile male) would not provide adequate support.

From the Gordon et al. (1988) survey, the 5th to 95th percentile range for buttock–popliteal length is 44.0 to 54.5 cm. In addition, it is recommended that the front of the seatpan be rounded (the “waterfall” front) in order to avoid pressure gradients on the underside of the thigh.

ANSI-HFES 100/1988 specifies a seatpan width of 45 cm. This is based on the hip breadth of the 95th percentile female. From the Gordon et al. (1988) survey, this value is 41.2 cm.

In traditional task chairs, the seatpan was sloped backward 3 to 5 degrees in order to allow the trunk to rest against the backrest. More recently, it has been recognized that tilting the seatpan forward will allow the trunk–thigh angle to open up (Mandal, 1986; Bridger, 1988). However, this effect may be countered by a tendency to slide out of the chair. The sliding tendency can be countered by use of kneepads, by training the user to exert counter-pressure by the legs (Dainoff and Mark, 1987), by building in a saddle-like contour in the front end of the seatpan (Corlett and Gregg, 1994), and by keeping the rear part of the seatpan level and inclining the forward part (Graf et al., 1993).

ANSI-HFES 100/1988 specifies that the backward inclination of the seatpan must be within 0 to 10 degrees. Forward inclination is permitted, but no ranges are specified.

Armrests

Whether or not armrests are provided, and if so, what their configuration should be, is an important issue in chair design. If fixed height armrests are provided, they cannot be higher than the 5th percentile female’s seated elbow height without interfering with seated posture of smaller users. This value, from Gordon et al. (1988), is 17.6 cm. The case against fixed armrests is that larger individuals using them for support will be inadvertently forced into awkward forearm posture. Also, unless carefully designed, armrests may keep the user from getting close to the worksurface, or catch on clothing. On the other hand, if users are properly instructed regarding working posture, fixed height armrests may be very helpful in supporting the arms during pauses between periods of keying or other work.

Adjustable height armrests are now widely available. They seem to be particularly useful with the advent of large-scale use of mice, trackballs, and other non-keyboard input devices. However, here again, proper instruction against misuse is important.

Adjustability Ranges

Achieving the functional goals of designing seating affordances within task and environmental constraints while accommodating individual variability (effectivities) is difficult to accomplish without some degree of adjustability of chair components. However, because of the complexity of the design problem space (the intersection of task, environmental and personal constraints), there is still much room for debate and disagreement as to which components should be adjustable and how much adjustment is necessary and desirable. This section will discuss the issue from an anthropometric and biomechanical perspective; the subsequent section will focus on more behavioral concerns.

Seatpan Height

The height of the seatpan would seem to be a straightforward question of locating a seating surface at the level of the underside of the thigh. This would allow the user’s thighs and buttocks to be firmly supported while his feet could rest firmly on the floor. The corresponding anthropometric dimension — popliteal height — has a 5th female–95th male percentile range of 35.1 to 47.6 cm according to Gordon et al. (1988), to which a correction for shoes (typically 2.5 cm) is added. However, several other constraints must be considered. Most important, the chair can be considered alone, but must be viewed within the context of the overall workplace. Thus, if fixed height worksurfaces are present, a small person’s elbow height would be well below effective working height. Published research summarized by Cornell and Kokot (1994) indicated that users tend to adjust their chairs above (i.e., 5 cm) their measured popliteal heights.

Furthermore, appropriate working heights for elbows and hands will be affected by whichever solution is employed to open up the thigh–trunk angle (see above). A forward-sloping seatpan will tend to raise the elbow height, while keeping the trunk erect; this may necessitate an increase in worksurface height.

On the other hand, a backward inclination of the trunk may also require a corresponding backward inclination and lowering of the seatpan. This would tend to lower the effective working height of the elbows.

In addition, seatpan height adjustment strategies must take into account clearance considerations under the worksurface. A forward-sloping seatpan may result in interference of the top of the thigh with the underside of the worksurface. With a backward inclined seat, the problem might be with the height of the knees.

The solution proposed by ANSI-HFES 100/1988 is to require seatpan height adjustability within a range of 40.6 to 52 cm. This is designed to accommodate both small females and large males at a fixed height (76.2 cm) worksurface in terms of working elbow height. It is recognized that a footrest would be essential for smaller persons under these conditions.

Backrest Angle

ANSI-HFES 100/1988 specifies that, if adjustable, backrest angles should incorporate some part of the range between vertical and 15 degrees backward from vertical. Larger inclinations of up to 30 degrees behind vertical can be beneficial in reducing disc pressure and muscle activity (Andersson et al., 1979).

Armrest Height

In considering height adjustment ranges for armrests, the applicable anthropometric dimension is seated elbow height (above seatpan surface). Applicable 5th female–95th male values from Gordon et al. (1988) are 17.6 to 27.4 cm.

Control Mechanisms

Providing user adjustability necessitates a consideration of control mechanisms. The following section provides a brief description of some issues relating to the functional characteristics of chair control mechanisms. This discussion will be expanded in a following section on system integration.

Helander, Zhang, and Michel (1995) listed 10 separate chair controls which could be considered characteristic of the best chairs available in the market at that time. These include: seat height, seatpan tilt, backrest height, backrest angle, back tension, armrest height, lumbar height, lumbar depth, seatpan tilt tension, and seat depth. This list will obviously need to be modified as new chair designs reach the marketplace, but it represents a good functional overview of the potential opportunities for flexibility and control available to the user.

In general, providing height adjustability has tended to be straightforward. Either a compressed gas mechanism controlled by a lever or button allows the height to be adjusted by the seated operator, or a mechanical mechanism is employed which requires the operator to leave the chair.

A larger variety of design solutions has been seen in the interaction between seatpan and backrest. Either one or both of these components can be made adjustable. There is a variety of adjustment possibilities. *Active* mechanisms require that the control mechanism must be activated while the surface (seatpan or backrest) is moved by applying force from the appropriate body surface. *Passive* mechanisms have no control mechanisms but adjust solely by force from body surfaces against some resistance. Mixed controls allow a combination of both. More complex mechanisms provide for the possibility of locking out the forward slope function.

In addition, where both seatpan and backrest are adjustable, the two components can either be independently controlled, or are mechanically linked. In the case of the latter, there is typically a ratio of 2 or 3 to 1 degrees of movement between backrest angle and seatpan angle.

Tension adjustments are sometimes provided to take into account the variation of user weight and strength relative to the force required to move seatpan and backrest surfaces.

System Integration: The Ecology of Seated Posture

The previous discussion has focused primarily on mechanical attributes of the chair, and biomechanical/anthropometric characteristics of the user. At this point, the focus of discussion will be expanded to conceptualize the seated worker within an overall workplace system.

Intentionality of the User: Task Demands and User Performance

Referring to the means–end abstraction hierarchy discussed in an earlier section, the overall system goal for the chair is to provide stability while the user is carrying out one or more sets of tasks.

At the same time, some degree of movement must be afforded, both to alleviate fatigue, and to respond (in most cases) to task demands which require changing postures. However, in framing this discussion, it is important to emphasize that, from the user's perspective, sitting is rarely a goal in itself. The chair, instead, must be regarded as a tool which allows accomplishment of a given task. This, of course, can include the task of resting, or even taking a nap! Accordingly, in considering task demands, the user's *intention* becomes of prime importance.

The incorporation of intentionality into the question of the ergonomics of sitting poses some interesting problems. For most users, most of their life experience has been with “ordinary” (i.e., non-adjustable) chairs. Hence, postural adjustments tend to be driven strictly by task constraints; for example, leaning forward to read a document lying flat on a table. The chair is a passive support structure which allows (affords) certain working postures; in another case (e.g., the document is too far to reach), the user simply leaves the chair. These postural adjustments operate primarily at an automatic level in the sense that the adjustments are below the level of conscious attention. However, the situation becomes more complicated once adjustable chairs are provided. Now, user intentionality must, at least initially, involve deliberate postural regulation through active chair adjustment. In a sense, operation of the chair becomes incorporated as part of the overall task demands. Accordingly, a human performance perspective must be added to the biomechanical focus previously adopted.

What Is the Operator's Task in Using an Adjustable Chair?

Helander et al. (1995) have characterized the operator's task in terms of the following sequential stages of problem-solving:

- a. Search: Can the chair control be located?
- b. Feedback: Can the mode of operation of the control be understood?
- c. Compatibility: Does the control allow adjustment to the desired position?

The introduction of an adjustable chair into a workplace necessitates that these additional task demands be incorporated in work design and training so that the added value — in terms of improved performance and reduced fatigue — which accompanies the introduction of this new productivity tool can actually be attained.

The landmark work of Rasmussen et al., (1995) on levels of performance can be helpful in this discussion. Rasmussen identified three distinct levels at which human performance can occur. The first or *skill* level, reflects largely automatic behavior governed by preprogrammed instructions. *Rule-based* performance applies to those kinds of familiar situations where behavior is controlled by stored sets of rules of the form “if A then B.” The third level is *knowledge-based* performance involving novel situations in which conscious analysis and planning is required.

The postural adjustments which occur in non-adjustable chairs typically exist at the mostly automatic skill-based level (e.g., bending forward to see better). When an adjustable chair is first encountered, a set of rules is developed which encompasses the first two stages of Helander et al. That is, the user learns *where* the controls are (search task) and *how* (feedback task) they function. An example of these stages in combination is the following: *IF* I press the button on the left, *THEN* the seatpan will lower.

This is the kind of information which typically is found on the hang tags or other instructional materials which accompany most ergonomic chairs, but which, unfortunately, are often removed before they reach

the end user. For this reason, chair designers often have as a goal, the design of controls which are “intuitive” in the sense that the “where” and the “how” tasks could be accomplished without written instructions.

To some extent, this is a reasonable requirement. Helander et al. (1995—Experiment 1) conducted an experiment in which 5 chairs, representing a range of control configurations, were presented to a group of 20 naive users. The users, who had no previous exposure to the chairs, were asked to identify and operate the controls. The chairs were independently rated by the authors as to how well they afforded accomplishment of each of the three tasks. The results indicated that the users were better able to identify the controls on the chairs which had the highest expert ratings on the first two tasks (“where” and “how”). Thus, chair controls which three professional ergonomists agreed were easy to find and easy to operate were, in fact, easy to find and operate by a group of naive users.

However, the third stage of Helander et al. (1995) is more problematic. The question of compatibility assumes that the user’s intention to place the chair in a given orientation can, in fact, be achieved by the chair characteristics. This is a more subtle issue, presupposing that the user understands, for each combination of chair control and task characteristics, what the desired postures should be. Coordinating the operation of multiple chair controls so as to optimize posture for a given set of task constraints can be considered knowledge-based performance, at least initially.

The Problem of Coordinating Multiple Controls

The extent of this problem can be seen in the case of those chairs which include all 10 of the chair adjustment controls described by Helander et al. (1995). While the tension, lumbar depth, and seat depth controls might be considered one-time only settings, there remain six independent adjustments which must be operated in coordinated fashion. This presents the operator with what has been discussed earlier as the *degrees-of-freedom problem* (Mark, Dainoff, Moritz, and Vogeles, 1991). Each separate control can be considered as an independent degree of freedom. It is possible that the user will understand the need to systematically explore the possible combinations of working postures which can result and intuitively find those which are optimum. A more likely possibility is that the operator will simply become overwhelmed and either ignore, or worse, misadjust control mechanisms. Karwowski (1991) has provided a more general description as to how this might occur.

A more reasonable approach is to try to understand the relationships between working posture and task constraints, and to then communicate these relationships as part of a training program for operators. Looking just at the relationship among three controls — seatpan angle, backrest angle, and seatpan height — Dainoff and Mark (1987) designed two simulated VDT tasks which differed in task constraints. High-speed data entry work required the fingers to be in close contact with the keyboard, the eyes in close contact with the paper source document. Editing was completely done on the display screen; the keying rate was less. In the analysis of the authors, the constraints of the editing task dictated an upright posture with the backrest vertical, the seatpan angled forward (for lumbar support), and the seatpan raised to correct for the angled seatpan. In this case, the visual demands were critical. The source document characters were approximately half the size of the screen characters. Consequently, the editing task, which was completely screen-based, allowed a longer viewing distance. Consequently, a more “relaxed” working posture in which both the backrest and seatpan angle were reclined rearward could be employed.

Utilizing this analysis, subjects were trained to use an ergonomic chair which had all three of the above controls. The alternative postures described above were suggested as hypotheses. Following training, subjects worked three hours per day for four days alternating between entry and editing tasks every 30 minutes. An incentive pay system was utilized, and fatigue was assessed throughout the course of each day’s session. Results indicated that the subject consistently used a forward-sloping upright backrest position for the entry task and a rearward inclined position for the editing task. In addition, although fatigue ratings increased over the course of each daily session, the average daily fatigue ratings *decreased* over the four days. An alternative explanation for the postural data might be that the subjects were simply following instructions blindly (the so-called demand characteristics explanation). However, this would

argue that subjects would deliberately work for 12 hours in suboptimal postures at the cost of higher incentive pay.

The results of Dainoff and Mark (1987) were followed up by two separate investigations. Helander et al. (1995—Experiment 3) had users evaluate four chairs in which the number of degrees of freedom of adjustability varied systematically. Chair #1 had height adjustment only with some flex in the seatpan and backrest. Chair #2 had a height adjustment, and a single adjustment in which seatpan and backrest were linked. Chair #3 had independent adjustments for height, seatpan tilt, and backrest tilt, but a single lock for seatpan and backrest. Chair #4 had independent adjustments for all three functions, and independent locking mechanisms for seatpan and backrest. Subjects were given essentially the same kinds of instructions as in Dainoff and Mark (1985). They were then asked to adjust each of the five chairs to both backward and forward postures and then rate the overall comfort of the chair. Videotape analysis was used to measure total adjustment time and number of adjustments made.

The results indicated a linear relation between chair complexity and rated comfort, time to adjust, and number of adjustments. Thus, these subjects seemed to be willing to take the additional time, and make the additional adjustments required in order to achieve a more comfortable posture.

The Question of Active or Passive Movement of Chair Surfaces

The second follow-up investigation involved a simulated work situation in which 12 operators worked for 180-minute sessions on two separate days alternating between 90-minute sessions of entry and editing (Mark, Dainoff, Moritz, and Vogeles, 1991). The ergonomic chair used in the previous study (Dainoff and Mark, 1987) was modified with potentiometers attached to seatpan and backrest controls, so that the angular position of seatpan and backrest surface could be continuously tracked throughout the study. In addition, the basic design of this chair included a capability to put the seatpan and backrest control into passive or “floating” mode. The previous studies had utilized only the active control model. However, in this study operators were assigned to both active and passive chairs on alternative days. As before, a day of training preceded the experiment in which the relationships between working posture (forward leaning for entry, backward leaning for editing) were proposed as recommendations which could be either accepted or not by the operator.

When the operators were using the active controls, the observed working postures were quite similar to the earlier results of Dainoff and Mark (1987). The operators seemed to follow the training recommendations in that the forward-leaning posture was used in the entry task, and the backward-leaning was used in the editing task. However, this did not occur when the same operators used the passive controls. The primary difference was found in the entry condition; the forward seatpan angle was not used, but positions were much more variable. The data appear to reflect attempts by the operators to search for a stable position. This was confirmed by comments of the operators in this condition in which terms like “rocking horse” and “seasick” were used.

The results from Mark et al. (1991) were subjected to additional analyses by Gardner, Mark, Dainoff, and Xu (1995). In these analyses, the relationship between seatpan and backrest angles was plotted individually for each operator. Of particular interest were the data from the data entry tasks when the chair was in passive mode. The seatpan–backrest angle relationships could be classified into two basic categories. Figures 20.2 and 20.3 illustrate typical results for both types. In each case, a characteristic pattern of activity is the linear relationship between both angles centered around the (zero degree) “cubist” position in which seatpan is horizontal and backrest vertical. These data are consistent with the “hunting” interpretation characteristic of an unstable posture. The operator attempts to achieve the forward-leaning posture by moving the seatpan and backrest forward, but this posture is perceived as unstable, so the seatpan and backrest are moved in the opposite direction, but not too far. These linear data are descriptive of a rocking motion around the cubist position. For comparison, a typical data pattern from the Entry Active condition is shown. Here, the seatpan remains clearly inclined downward, while some experimentation with the backrest is carried out. Finally, the vertical “tail” in Figure 20.3 reflects a second group of operators who appeared to “give up” the search for a stable equilibrium position close to the vertical.

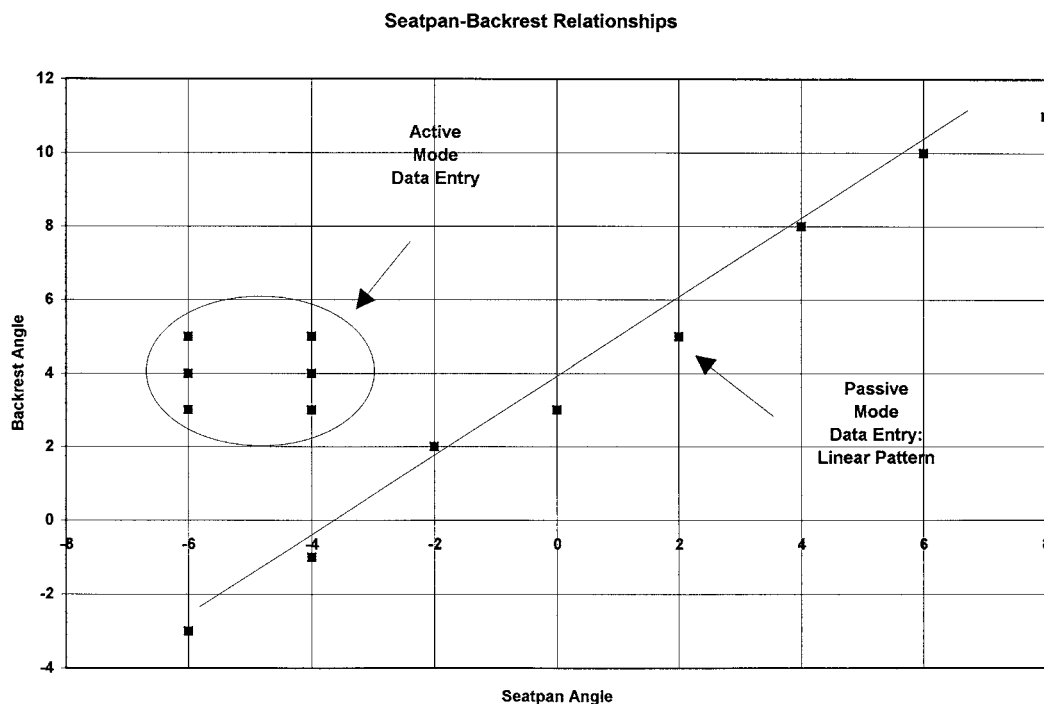

FIGURE 20.2 Typical patterns of results from experiment of Gardner et al. (1995). Illustrated are relationships between seatpan and backrest angles during data entry work during which chair was in active and passive modes of adjustment.

These people moved the seatpan to its maximum (but stable) backward inclination, and varied their posture only by moving the backrest.

In the editing tasks, operators in both active and passive modes tended to look like the vertical portion of Figure 20.3.

A second goal of this study was to utilize these results as a means of assessing the design feature of linked seatpan and backrest angles. For such chairs, the industry standard appears to require ratios of backrest to seatpan angles of either 2:1 or 3:1. That is, for every 1 degree of rotation of the seatpan, the backrest will move either 2 or 3 degrees. Note that linkage can be found in either active or passive modes of adjustment. In the present study, if the chair mechanism had been linked, the resulting postures would have fallen along a straight line with a slope of either 2 or 3. (See Figures 20.2 and 20.3.) To assess how many of the operators would have normally adjusted their chairs to approximate these ratios, the slopes of the linear portions of the curves were computed for each of the individual plots. The results indicated that most (73%) of the resulting slopes were less than 2. This outcome, together with the appearance of a nonlinear component in many of the plots, indicates that these users adjusted their chairs to postural orientations which would have been impossible had they been using a chair with a linked mechanism.

While these studies utilized somewhat artificial laboratory tasks, the characteristics of the study were carefully chosen to represent two extremes of keyboard-intensive work. The entry task involves close visual attention to paper copy and rapid keying. The editing task requires close visual attention to the display screen, but much less typing. It is assumed that typical office work will represent a mix between these two extremes, and would, consequently, involve an alternation of working postures. The outcome of these studies would seem to argue that, for such computer-intensive tasks, an ergonomic chair with active controls which independently operate seatpan and backrest angles will, with proper training, allow the user to effectively attain a desired work posture. The key element, however, is proper instruction.

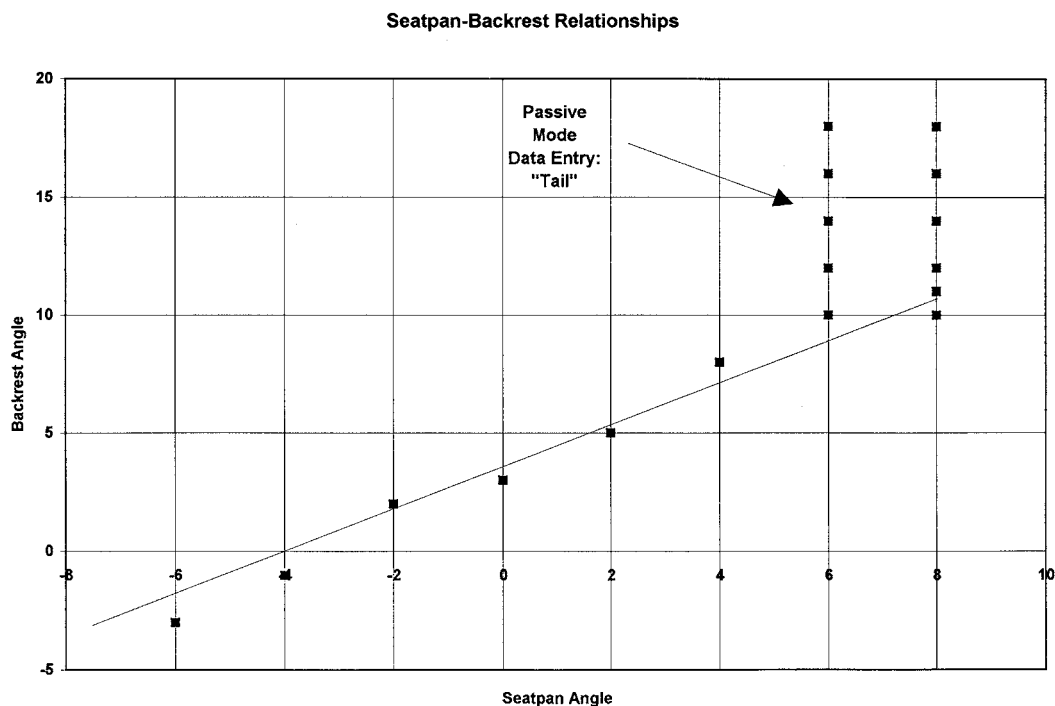

FIGURE 20.3 Typical pattern of results from experiment of Gardner et al. (1995). Illustrated is a second example of the relationship between seatpan and backrest angles during data entry work during which chair was in the passive mode of adjustment.

Thus, the advantage of the linked mechanism in terms of simplifying the user's control problem, must be balanced against the demonstration that such mechanisms exclude postural orientations which might otherwise be desired. Likewise, passive controls eliminate levers and buttons, but at the potential cost of postural instability.

Relationship of Seated Posture to User's Reach Capabilities

A final set of research results is relevant. The concept of *reach envelopes* is fundamental to workplace design and layouts. Reach envelopes refer to regions in three-dimensional space where task-related devices, such as controls, are reachable without bending or moving. Reach envelopes have been derived from anthropometric models, empirically derived reach contours (in which a representative range—typically 5th percentile female to 95th percentile male—of users attempts a set of standardized reaches), or a combination of the above. (See, for example, Kroemer et al. [1994; pp. 29-35] or Sanders and McCormack [1993, Chapter 13].) However, these approaches have been based strictly on static postures and have failed to take seating variables into account.

A recent set of studies by Mark and his colleagues (1997) has brought a new, more dynamic perspective to this question. Consider a person who initially starts walking slowly, and then gradually begins to increase speed. At some point, the pattern of movement we call "walking" will become inefficient, and the person will switch to a new *action mode* which might be called "jogging." As speed increases even further, jogging will give way to "running." It should be noted that fast walking and jogging can coexist at the same speed, but jogging will be more physiologically efficient. (These arguments are based on the classic work of Hoyt and Taylor (1981) who measured energetic changes as horses moved from walk to trot to canter to gallop.) Mark et al. (1997) applied the same analysis to seated reach. They defined the *absolute critical boundary* as the maximum distance, for any given person, which can be reached without moving the shoulder away from the backrest (action mode 1). Beyond this point, a second action mode

comes into play — namely, reaching which includes shoulder rotation and/or bending of the trunk (action mode 2).

However, in parallel to the work of Hoyt and Taylor (1981), Mark et al. (1997–Experiment 1) discovered the presence of a *perceived critical boundary* — where the individual started to switch action modes from the first to the second action modes. This transition occurred, on the average, at 85% of each person's absolute critical boundary. In the same experiment, the actors were asked to maintain the arm-only action mode for reach distances out to the absolute critical boundary while making comfort ratings of each reach. The rate of decrease in mode 1 comfort ratings with reach distance corresponded exactly with the (previously established) rate of decrease in mode 1 reaches. These results support the interpretations that even though the actor is physically capable of reaching objects within the last 15% of the distance to his/her maximum capability using action mode 1, it is more efficient/comfortable to switch to action mode 2.

The practical consequences of this finding relate to workstation layout. The actual distance between perceived and absolute critical boundaries is on the order of 8 cm. This distance can be of practical significance in a crowded work area. A target located in the zone between the perceived and actual critical boundaries might result in arm muscle strain, if the act is repeated over prolonged periods with insufficient rest breaks.

Furthermore, and more to the point of this chapter, the location of the perceived critical boundary is effected by the characteristics of the chair. Mark et al. (1997–Experiment 2) repeated the reach experiments using three different chair configurations. An ergonomic chair was used to position the actors in the following positions: forward leaning (backrest vertical and seatpan inclined 8 degrees forward); upright (backrest vertical and seatpan horizontal) and extreme backward leaning (backrest at 28 degrees from vertical; seatpan at 24 degrees from horizontal). The results indicated that the preferred critical boundary appeared earliest for the forward leaning position, next for the upright leaning position, and essentially corresponded with absolute critical boundary for the backward leaning position. The importance of this finding is the demonstration that not only does the reach envelope (location of the absolute critical boundary) decrease with backward inclination, but that there is a corresponding decrease in the difference between perceived and absolute critical boundaries.

Moreover, the next experiment in this series (Mark et al., 1997–Experiment 3) found the relationship between perceived and absolute critical boundaries was subject to biodynamic manipulation. Experiment 3 was a replication of Experiment 2 except that the “chair” was simply two flat but padded boards, in which the backrest could be inclined from 30 degrees backward to vertical. The result of this manipulation was that virtually all actors maintained their mode 1 reaches up to their absolute critical boundary regardless of the backrest inclination. It appears that the lack of padding and contoured surfaces had the effect of reducing the stable support structure from which the more complex but efficient mode 2 reach act could be organized. This finding is of some theoretical importance, but also presents a practical opportunity. There is much debate among chair designers as to how much contouring and padding is appropriate. This experimental procedure has great promise as an assessment tool for comparing alternative chair designs.

20.8 Discussion

This chapter has attempted to present a systematic, integrated overview of issues related to the seated workplace. Working within the structured framework of the means–end abstraction hierarchy, it was argued that in order to achieve the overall system goals of stability and movement for the seated operator, it is necessary to consider interactions among task demands, user characteristics, and chair features. When the task requires close linkages between eye and display screen/copyholder, and fingers and keyboard/mouse, these demands tend to drive postural orientations. To the extent that the chair can provide support for these postural orientations through adjustability, it can be considered an effective ergonomic chair for that situation. However, increased adjustability is achieved at the cost of complexity. If the adjustment possibilities are designed into the chair itself, through linked controls and/or passive

movement, the operator has less cognitive demand, but also has less control in the sense that certain postures which he or she may desire are likely to not be available. Putting the operator more in control, with active controls, also requires a higher degree of training and education. However, such training would seem to be a reasonable investment in achieving the real benefits of an adjustable chair as an essential component of the modern workplace.

Defining Terms

Active Control Mechanism: Adjustment mechanism of chairs which require the operator to perform a positive action on the control mechanism to move the chair. See **Passive Control Mechanism**.

Affordance: Attributes of the surrounding environment which allow a given individual to perform specific actions. Physical properties measured with respect to an individual.

Degrees of Freedom Problem: Generalized description of the requirement for the operator to coordinate multiple adjustment mechanisms simultaneously.

Effectivity: Characteristics of the individual which allow or constrain his/her capabilities for actions within a given environment.

Kyphosis: Flattening of the curvature of lower (lumbar) region of the spine. May occur during unsupported sitting. See **Lordosis**.

Lordosis: Inward curvature of the lower (lumbar) region of the spine which occurs naturally when standing.

Means–End Abstraction Hierarchy: Conceptual tool for analyzing complex systems. Consists of a hierarchy of affordances in which lower levels are the means for allowing desired actions (ends) to be realized.

Passive Control Mechanism: Adjustment mechanism of a chair in which the chair surface may move as the operator moves his/her body. See **Active Control Mechanism**.

Reach Envelope: A three-dimensional region in front of an operator within which objects can be manipulated without bending or stretching.

References

- Andersson, G.B.J. and Ortengren, R. 1974. Lumbar disc pressure and myoelectric back muscle activity during sitting. *Scandinavian Journal of Rehabilitation Medicine*, 6, 115-121.
- Andersson, G.B.J., Murphy, R.W., Ortengren, R., and Nachemson, A.L. 1979. The influence of backrest inclination and lumbar support on lumbar lordosis. *Spine*, 4, 52-58.
- Bendix, T., Poulsen, V., Klausen, K., and Jensen, C. 1996. What does a backrest actually do to the lumbar spine? *Ergonomics*, 39, 533-542.
- Branton, P. 1976. Behaviour, body mechanics and discomfort, in E. Grandjean (Ed.), *Sitting Posture*. London: Taylor and Francis, Ltd.
- Chaffin, D.B. and Andersson, G. 1991. *Occupational Biomechanics*. (2nd Ed.) Wiley-Interscience. New York.
- Corlett, E.N. and Eklund, J.A.E. 1984. How does a backrest work? *Applied Ergonomics*, 15, 111-114.
- Corlett, E.N. and Gregg, H. (1994) Seating and access to work, in R. Lueder and K. Noro (Eds.) *Hard Facts About Soft Machines: The Ergonomics of Seating*. London: Taylor and Francis.
- Cornell, P. and Kokot, D. 1994. Use of adjustable VDT stands in an office setting, in R. Lueder and K. Noro (Eds.) *Hard Facts About Soft Machines: The Ergonomics of Seating*. London: Taylor and Francis.
- Dainoff, M.J. and Dainoff, M.H. 1986. *People and Productivity: A Manager's Guide to Ergonomics in the Electronic Office*. MDA Books, Cincinnati, Ohio.
- Dainoff, M.J. and Mark, L.S. 1987. Task and the adjustment of ergonomic chairs, in B. Knave and P.-G. Wideback (Eds.) *Work with Display Units 86*. Amsterdam: Elsevier (North-Holland).
- Dainoff, M.J. and Mark, L.S. 1989. Instabilities in seated posture and the ergonomics of perception and action. Fifth International Conference on Event Perception and Action. Miami University, Oxford, Ohio.

- Gardner, D.L., Mark, L.S., Dainoff, M.J., and Xu, W. 1995. Considerations for linking seatpan and backrest angles. *International Journal of Human Computer Interaction*, 7, 153-165.
- Gibson, J.J. 1979. *The Ecological Approach to Visual Perception*. Boston: Houghton Mifflin.
- Gordon, C.C., Churchill, T., Clauser, T. E., Bradtmiller, B., McConville, J.T., Tebbetts, I., and Walker, R.A. 1989. 1988 Anthropometric Survey of U.S. Army Personnel: Summary Statistics Interim Report (Technical Report NATICK/TR-89-027). Natick, MA: United States Army Natick Research, Development and Engineering Center.
- Graf, M., Guggenbühl, U., and Krueger, H. 1993. Investigations on the effects of seat shape and slope on posture, comfort, and back muscle activity. *International Journal of Industrial Ergonomics*, 1993, 12, 91-103.
- Grandjean, E., Hunting, W., and Pidermann, M. 1983. VDT workstation design: preferred settings and their effects. *Human Factors*, 25, 161-175.
- Grieco, A. 1986. Sitting Posture: An old problem and a new one. *Ergonomics*, 29, 345-362.
- Helander, M. 1995. *A Guide to the Ergonomics of Manufacturing*. London: Taylor & Francis.
- Helander, M.G., Zhang, L., and Michel, D. 1995. Ergonomics of ergonomic chairs: a study of adjustability features. *Ergonomics*, 38, 2007-2029.
- Hoyt, D.F. and Taylor, R. 1981. Gait and the energetics of locomotion in horses. *Nature*, 292, 239-240.
- Karwowski, W. 1991. Complexity, fuzziness, and ergonomic incompatibility issues in the control of dynamic work environments. *Ergonomics*, 34, 671-686.
- Kroemer, K.H.E., Kroemer, H.B., and Kroemer-Ebert, K.E. 1994. *Ergonomics*, Englewood Cliffs, N.J.: Prentice-Hall.
- Lederman, L. 1993. *The God Particle*. New York: Dell.
- Lueder, R. and Noro, K. *Hard Factors about Soft Machines: The Ergonomics of Seating*. London: Taylor and Francis.
- Mandal, A.C. 1981. The seated man (homo sedens). The seated work position. Theory and practice. *Applied Ergonomics*, 12.1, pp. 19-26.
- Mandal, A.C. 1986, The influence of furniture height on back pain, in B. Knave and P.-G. Wideback (Eds.) *Work with Display Units 86*. Amsterdam: Elsevier (North-Holland).
- Mark, L.S. and Dainoff, M.J. 1988. An ecological framework for ergonomic research. *Innovation, The Journal of the Industrial Designers Society of America*, 7.2, 8-11.
- Mark, L.S., Dainoff, M.J., Moritz, R., and Vogele, D. 1991. An ecological framework for ergonomic research and design, in R.R. Hoffman, and D.A. Palermo (Eds.). *Cognition and the Symbolic Processes: Volume III*. Hillsdale, NJ: Erlbaum Associates.
- Mark, L.S., Nemeth, K., Gardner, D., Dainoff, M.J., Paasche, J., Duffy, M. and Grandt, K. 1997. Postural dynamics and the preferred critical boundary for visually-guided reaching. *Journal of Experimental Psychology: Human Perception and Performance*, 25, 1365-1379.
- Nemeth, K.J. and Dainoff, M.J. 1997. Inappropriately applying anthropometric methods for ergonomic design testing. Proceedings of the International Ergonomics Association 13th Triennial Congress. Tampere, Finland.
- Nubar, Y. and Contini, R. 1961. A minimal principle in biomechanics. *Bulletin of Mathematical Biophysics*, 23, 377-391.
- Pheasant, S. 1986. *Bodyspace: Anthropometry, Ergonomics and Design*. London: Taylor and Francis.
- Rasmussen, J., Pejtersen, M., and Goodstein, L. 1995. *Cognitive Systems Analysis*. New York: Wiley.
- Robinette, K.M. and McConville, J.T. 1981. An Alternative to Percentile Models. Society of Automotive Engineers Technical Paper Series, International Congress and Exposition. Detroit, Michigan.
- Sanders, M.S. and McCormick, E.J. 1993. *Human Factors in Engineering and Design*. (7th ed.) New York: McGraw-Hill.
- Stewart, D. 1987. Modern designers still can't make the perfect chair. *Smithsonian*, 1, 97-105.
- Vicente, K.J. and Rasmussen, J. 1990. The Ecology of Human-Machine Systems II: Mediating "Direct Perception" in Complex Work Domains. *Ecological Psychology*, 2, 207-249.

Zacharkow, D. 1988. *Posture: Sitting, Standing, Chair Design and Exercise*. Springfield, Il.: Charles C Thomas.

Zehner, G.F., Meindl, R.S., and Hudson, J.A. 1993. *A Multivariate Anthropometric Method for Crew Station Design: Abridged*. (Tech. Report AL-TR-1992-0164). Wright-Patterson Air Force Base, Ohio: Air Force Material Command, Armstrong Laboratory.

For Further Information

In addition, Zacharkow (1988) and Lueder and Noro (1994) provide extensive discussion of seating issues.

21

Seating and Posture in VDT Work

21.1	Introduction	21-1
21.2	Elements of Spine Biomechanics	21-2
21.3	Nutrition Mechanism of the Intervertebral Disc and Paravertebral Soft Tissue.....	21-2
21.4	Musculoskeletal Disorders in VDT Work	21-3
	Task- and Workplace-Related Factors • Psychosocial Factors • Non-Task-Related Factors	
21.5	Seating and Posture in VDT Work	21-5
21.6	Requirements and Characteristics of a VDT Workstation	21-6
	Chair • Desk	
21.7	Organizational Factors.....	21-9
21.8	Conclusions	21-10
21.9	Summary	21-11

Antonio Grieco

University of Milan

Giovanni Molteni

University of Milan

21.1 Introduction

Proper workplace design is a necessary prerequisite for persons whose jobs require them to spend considerable periods of time seated in front of a video display terminal (VDT). To be considered proper, a workplace should at least be adaptable to meet the anthropometric characteristics of 90% of the potential users, and should be physiologically comfortable. The application of correct ergonomic criteria has led to considerable workplace improvements for VDT users, decreasing the musculoskeletal disorders due to unhealthy posture.

However, it has been shown, investigating the effect on posture of changing from an old to a new ergonomically designed workstation in a switchboard control room, that ergonomically designed workplaces increase postural fixity. A prolonged fixed posture can in itself be considered a risk factor, particularly for the lumbar spine, where correct intervertebral disc nutrition depends mainly on alternating hydrostatic pressures, above and below a critical hydrostatic pressure value (Cantoni, 1984; Kraemer, 1977).

The changes in work processes are rapidly leading us to spend more and more of our time in positions that tend to be fixed, both at work and at leisure, and in this respect, postural fixity may be a very important adverse factor for our osteomuscular apparatus.

These two brief considerations move our attention to the fact that ergonomically designed workplaces are useful for avoiding unhealthy posture, but do not solve all the problems related to posture in VDT work.

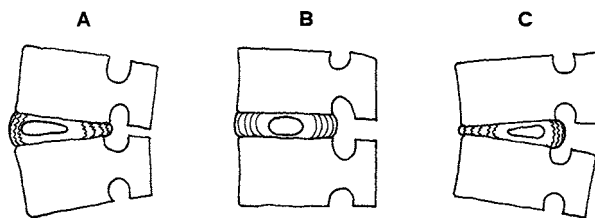

FIGURE 21.1 Disc displacement in extended (A), neutral (B), flexed (C) trunk position.

21.2 Elements of Spine Biomechanics

In order to stand erect, the spine had to be repositioned from horizontal, in the primate posture, to vertical position in erect posture. This could not be achieved by simply rotating the pelvis on the vertical femur by 90 degrees until the trunk is erect, because the extension of the femora, required for walking, is then impeded by the ischium. Further, the sacrum cannot be rotated backward with respect to the ilium and, in this condition, the birth canal would be obstructed by the coccyx. The evolutionary solution seems to have been rotating the sacrum forward on the ischium and increasing the extension of the lumbar spine. This is the origin of the lumbar lordosis (Bridge, 1991).

In the standing adult, the lumbar lordosis supports the upper body so as to minimize the bending moment of the spine, and the body line of gravity passes through the facet joints of the fourth and the fifth lumbar vertebra (Klausen, 1968).

The spine itself lacks intrinsic stability and short and long back muscles together with anterior abdominal muscles are responsible for the stabilization of the spine as a whole, when the line of gravity of the upper body parts passes ventrally or dorsally to the axis of movement of the lumbosacral joint. This means that posture should be analyzed not only in terms of joint angles and depth of spinal curves but also in terms of the strain imposed on the stabilizing muscles (Nachemson, 1976).

Sitting position ensures less total body energy expenditure and major body stability. When the person is seated, the thigh is horizontal, the hip joint is flexed, and the pelvis has a sloping axis. In this condition, the lumbar spine straightens from its normal lordotic curve and exhibits a kyphosis curve when bending forward. In both cases, the disc protrudes posteriorly from its normal position between the vertebral bodies and impinges on the spinal cord. Bending forward in the seated position, moves the anterior part of the vertebral bodies closer together, increasing the posterior force on the disc, which may increase the stress on spinal tissue (Figure 21.1.).

21.3 Nutrition Mechanism of the Intervertebral Disc and Paravertebral Soft Tissue

Examining the genesis of spine pain ascribed to soft tissue showed how some of the pain was essentially due to a process of protracted isometric contraction by the paravertebral muscles (Caillet, 1973). In some cases, the pain is directly generated by the overuse of the myofascial formations where the paravertebral muscles intervene at the periosteal level. In the majority of cases, however, prolonged isometric contraction causes a constant increase in endomuscular pressure, with relative constriction of the blood vessels and consequent ischemia. The resulting pain is due to a relative oxygen deficiency, to the action of irritating metabolites, to the accumulation of lactic acid, and to the reduced intracellular concentration of potassium. The condition of localized hypoxemia may be the cause for muscular degeneration, that may lead to a fibrotic reaction of both the muscle and the surrounding tissue (Figure 21.2) In light of these comments, it should be kept in mind that while isometric contractions up to 20% of the maximum voluntary contraction are accompanied by an increase in blood supply to the muscle, for isometric contractions above this level, a decrease in the blood circulation and thus, a condition of relative

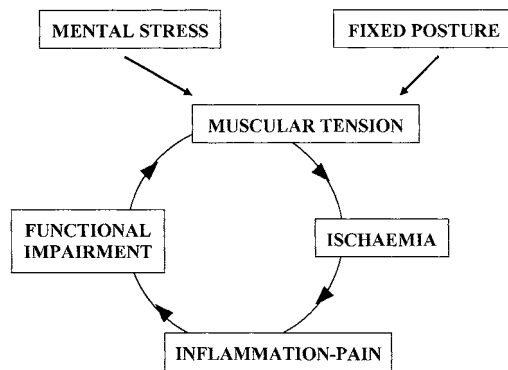

FIGURE 21.2 Role of fixed posture and mental stress in the pathogenesis of functional muscular impairment and pain.

hypoxemia, begins to occur (Barnes, 1980; Edwards, 1972). The level of isometric contraction near or above 20% of the MVC is easily reached, for example during digital keyboard operations, in the trapezius and elevator muscles of the arm, particularly when the upper limbs are unsupported. The result is that, especially in the paravertebral muscles and the shoulder girdle muscles, nonmaximal protracted isometric contractions, which are typical of fixed postures, may lead not only to sensations of discomfort and pain in the short term, but may also eventually lead to the onset of a real disease due to alterations of the soft tissue in the long term.

The second structure worth considering in this context is the intervertebral disc. This structure is avascular in the adult, and therefore its nutrition depends on the process of diffusion of substances from adjacent tissues.

Disc nutrition through diffusion depends on a complex relationship between hydrostatic pressure and osmotic pressure inside and outside the disc itself; a decrease in hydrostatic pressure promotes the input of nutritional substances in the disc, and slows down the expulsion of catabolites, while an increase causes an inverse process (Kraemer, 1977; Nachemson, 1968; Ogata, 1981). In the first condition, the input of nutritional substances is accompanied by an increase in disc volume; in the second case, however, the disc tends to lose water and decreases in volume. This phenomenon is so well known that some authors (Eklund, 1984), have decided to use it as a measurement of spinal loading effects.

On the basis of this knowledge, it becomes clear that the optimum in the disc nutritional process is determined also by the constant alternation between conditions of loading and unloading of the disc itself. On the contrary, prolonged conditions of overloading or underloading of the disc, as can occur in prolonged fixed posture, obstruct nutritional exchange and can, in the long term, promote degeneration processes of the disc. There is a threshold value of intradiscal lumbar pressure (80 kg) which acts as a discriminating factor between conditions of overload and underload. When the lumbar spine and upper limbs are completely supported, the lumbar load is below the threshold value, while with the spine nonsupported and upper limbs raised, the lumbar load is above the threshold value (Colombini, 1985).

It can, therefore, be concluded that ergonomically designed chairs with supports for the trunk and upper limbs improve general comfort, but do not essentially alter the problems of lumbar disc metabolism.

21.4 Musculoskeletal Disorders in VDT Work

Musculoskeletal disorders among VDT operators are very diffused, even if the actual prevalence is not well known. In fact, according to various studies, the prevalence rates vary from 1% to more than 50% (Silverstein, 1986). The symptoms are reported in the form of pain, soreness, aching, stiffness, numbness, tremors, fatigue, and cramps that occur in specific parts of the body, but more frequently in the neck, back, and upper limbs. Also the occurrence varies daily, weekly, monthly, or occasionally.

The variability in form, occurrence, and anatomic location of symptoms indicates that the etiology of musculoskeletal disorders may be due to different risk factors and that, at the present, it is not yet well understood. However, three factors appear to be mostly related to musculoskeletal disorders in VDT operators: task- and workplace-related factors, psychosocial factors, and non-task-related factors.

Task- and Workplace-Related Factors

It has been shown that the various office jobs can give rise to different incidences and anatomic locations of musculoskeletal disorders (Hunting, 1981). The highest incidence was found in jobs involving repetitive keyboard work (data entry operators) with anatomic location mainly in neck and upper limbs, while in less repetitive work (conventional operators), the incidence was lower and equally located in different parts of the body.

The daily hours and years of computer use showed a statistically significant positive relationship with musculoskeletal disorders. It is worth pointing out that as the average daily hours increase, the percentage of operators with complaints increases at a greater rate than for years of computer use (Hochanadel, 1995).

As far as the types of workstation furniture and the perception of low back support are concerned, pneumatic adjustable chairs were judged to ensure good back support by 80% of users, manual adjustable chairs by 51%, fixed height chairs by only 41%, and the occurrence of symptoms in back and neck came out to be inversely correlated. On the other hand, no significant difference was found when comparing symptom responses in VDT operators using adjustable keyboard tables with those using fixed-height tables (Hochanadel, 1995).

Improper keyboard height relative to the operator's stature seems to be responsible for a high percentage of symptoms, particularly in neck and upper limbs, and for reduced work efficiency.

Of the mechanical problems that can be found in workstations, the more frequent are inadequate legroom, drawer under the keyboard, and tables with sharp edges. When these three mechanical problems are present at the same workstation, the percentage of symptoms rises to 75% (Hochanadel, 1995).

The use of non-keyboard computer input devices, like the computer mouse, has been associated with symptoms in the shoulder, wrist, and fingers.

The use of the mouse requires exertion of force with the finger and palm to overcome the button, gravity, inertia, and friction forces. The force may be transferred through the surface of the skin and causes stress on the contact area. In addition, the side-to-side movement of the mouse requires radial and ulnar deviation of the wrist, together with flexion and extreme extension and static load on the shoulder region. These two risk factors, force and *non-neutral* postures of the wrist, if frequency and duration of exposure are elevated, are associated with upper limb musculoskeletal disorders, in particular with carpal tunnel syndrome (Armstrong, 1995). In fact, the static load imposed on the upper part of the trapezium muscle fibers, with induced ischemia and release of metabolites such as bradykinin, may induce persistent pain; extreme wrist positions may stimulate pain receptors in the joint capsules or ligaments, rapidly causing pain (Hagberg, 1995).

Psychosocial Factors

In addition to biomechanical and ergonomic risk factors, psychosocial work factors and psychological stress have been postulated to be related to musculoskeletal disorders in VDT operators. Recently, it has been recognized that musculoskeletal and stress problems may be interrelated: they may influence each other or may have some common causes (Carayon, 1995). Psychosocial work factors such as workload, work pressure, fast work pace, time pressure (high demand), low control over work, poor intellectual discretion, and technological obsolescence (poor resources) are related to job stress, which in turn is related to musculoskeletal problems. Psychological and physiological pathways have been put forward to explain that job stress may change the perception of symptoms or induce psychological changes that may result in musculoskeletal problems. One of the hypotheses is that job stress may increase static muscle activity. Prolonged exposure to static muscle activity may lead to increased lactic acid and lack of nutrients

and, in the long term, provoke pain due to the inability of, or insufficient time for, the muscles to recover from fatigue (Bongers, 1995; Lim, 1995). On the other hand, job stress could have another type of indirect effect on musculoskeletal disorders via ergonomic risk factors. VDT operators under stress may adopt awkward posture or may use higher force to press on the key of the keyboard or perform their activities at a higher level of repetitiveness (Carayon, 1995).

Non-Task-Related Factors

All the symptoms and medical conditions which have been attributed to VDT use occur within the population with a certain baseline frequency, and it would be surprising if VDT users did not experience everyday ailments, symptoms, and adverse health outcomes with at least the same frequency as any other comparable group of workers (Pearce, 1995). Biodemographic factors, such as age and sex, previous musculoskeletal injuries, emotional stress, family burden, or environmental risk factors can play an important role.

The question is whether VDT operators experience significantly higher levels of musculoskeletal symptoms and adverse health outcomes than any other comparable group of workers. In this sense, it is important to emphasize that in epidemiological studies among VDT operators, there is a need for appropriate reference data, stratified for age and sex, collected among a working population not exposed to occupational risk factors, such as heavy manual handling, awkward and prolonged fixed postures, and whole body vibration. Comparisons are thus possible between frequency of disorders in the exposed and nonexposed subjects; in cases when a significant excess of disorders is demonstrated in the exposed as compared with the nonexposed subjects, ground could be laid for speculation concerning the etiology of the link between occupational risk and disorders. However, with cross-sectional studies, which are the most frequent in the literature, it is not possible, except for particular cases, to reach definite conclusions on such links, which should normally be obtained from longitudinal studies.

21.5 Seating and Posture in VDT Work

Three different and alternative sitting postures have been proposed for a VDT operator: the upright posture (ANSI, 1988), with the joints of the hip, knee, and ankle at right angles, the backward leaning (Grandjean, 1983), and the forward tilted (Mandal, 1991).

The first one seems not to be supported by any physiological or orthopedic reason and, in real life conditions, is quite seldom spontaneously chosen by VDT operators.

The second one has been experimentally demonstrated to reduce the pressure on the intervertebral disc and the stress on back muscle (Grandjean, 1983). However, this posture increases the viewing distance and forces VDT operators to flex the neck, increasing the risk of pain in this part of the spine.

The forward-tilted posture is suggested because in this position the pelvis rotates forward and the lower vertebral bodies are kept vertical, reducing in this way the intervertebral pressure and the lumbar share forces (Mandal, 1991). This posture is unusual and requires supporting the body weight with the feet placed on the floor or the knee on a special pad, and thus it may not be suitable for all VDT operators.

Advantages and disadvantages of the three sitting postures might be increased or reduced in relation to the tasks performed and the working conditions, respectively (Dainoff, 1987).

The upright posture has been suggested as the best for typing tasks, the forward-tilted posture when the viewing distance is the most important factor and the need to write on paper is frequent, while the backward-leaning posture, which decreases the pressure on the intervertebral discs but increases the viewing distance, is considered to be good for tasks mostly requiring screen work and for which the viewing distance is not a critical factor (Mandal, 1991).

Specific solutions should obviously be tailored to a specific task, but general guidelines are necessary, taking into account that: *the VDT workplace configuration is to be designed in such a way as to avoid forcing the operator into awkward or fixed postures; there is not a single working posture that is optimal for all VDT*

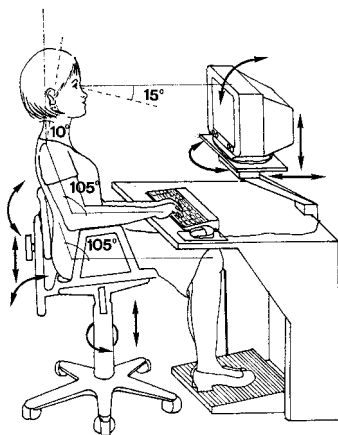

FIGURE 21.3 Ideal static reference posture for VDT operator.

tasks, and finally even the most correct working posture becomes uncomfortable if maintained for prolonged periods of time.

An ideal static reference posture, based on ergonomic criteria, should be defined, not intended as fixed but to provide a generally corrected basis and a *starting posture* able to allow VDT operators to easily change the working position. From this reference posture, requirements for furniture and workstation configuration should be derived. Finally, linear dimensions and profile adjustability features of the components of the workplace should be established on the basis of general population anthropometric parameters to satisfy the needs of 90% of the potential users and to facilitate the movement of the body.

According to biomechanical and psychological criteria and to a recent study (Hochanadel, 1995), the ideal static posture should be characterized by *neutral wrist posture* to reduce pressure in the carpal tunnel, *shoulders relaxed* to prevent static muscle activity in the neck and shoulder, *trunk slightly reclined and relaxed* to minimize intradiscal pressure at lumbar spine level, *limited neck bending* to avoid increase in tone of the anterior neck musculature, and *knees at the level of or slightly higher than hips and feet supported* to decrease pressure on the thigh.

The resulting position of the VDT operator can be described as: elbows at keyboard height with forearms parallel to floor, upper limbs in line with trunk, trunk reclined between 100° and 110°, neck flexion not exceeding 15°, eyes in line and at VDT screen level, knees at the level of or slightly higher than the hips, and feet on the floor or footrest (Figure 21.3).

To ensure this ideal posture, the essential required characteristics of workplace components are: proper adjustable chair with back and arm–wrist support, table with adequate height, depth, and legroom, and a footrest, if needed.

21.6 Requirements and Characteristics of a VDT Workstation

A basic VDT workstation is composed of a chair, desk, video display, and keyboard.

Chair

The chair is the most important component, since it interacts with other components and significantly influences operator comfort. Recent changes in the manufacturing and marketing of VDT chairs have led to an increasingly widespread exploitation of the ergonomic quality of chairs; in other words, the ergonomic characteristics have become a determining factor in marketing. But what are the characteristics and requirements on the basis of which a work chair can be defined as ergonomic? In the literature, ergonomic rules relative to the characteristics of the chair have so far been expressed too briefly and in a disorganized way, mainly referring to dimensions and comfort rather than to safety or performance.

To overcome this fragmented approach, all aspects should be properly considered when evaluating work chair ergonomics.

The basic requirements that the VDT chair should meet in order to be defined as ergonomic are (Drury, 1982; Drury, 1985; Occhipinti, 1993):

Safety: the chair must not be a source or cause of accidents.

Adaptability: the chair and its components should have the correct dimensions and be easily adjustable to meet the anthropometric needs of a wide range of users (normally at least 90% of the potential users).

Comfort: the chair and its components should be upholstered, contoured, and reciprocally adjustable so as to meet the physiological needs and characteristics of many different “body curves and shapes.”

Practicality: the chair and its components must be easily adjustable by the user; the covering materials should be hygienic.

Solidity: the chair, its components, and relative adjustment controls should be reliable, maintaining the same performance over time.

Safety

- In plan view, the area of the supporting base should contain the surface area of the seat to ensure chair stability.
- Pressurized gas springs for adjusting the seat and the inclination of the backrest should be approved and tested by qualified standards authorities.
- It should not be possible to activate the chair adjustment controls unintentionally, especially if they are of the mechanical type.
- The components should be made of nonflammable materials.
- A range of casters should be available with braking and anti-skid features for different type of floors.
- There should be no sharp edges.
- Armrests should not be open in front and in the back.

Adaptability

Adaptability is ensured when the range of variables concerning the measurements and adjustment positions of the chair components meet the variability of potential users. In Table 21.1 recommendations for chair adjustability are given.

The anthropometric distribution considered is that of an adult western population (Pheasant, 1986). A fixed working surface height of 72 to 75 cm has been considered, since it represents a physiologically and economically satisfactory solution and doesn't allow only a minimum percentage of taller men to cross their legs.

- Seatpan height range has been defined considering the trend of growth of the popliteal height parameter in the population and the thickness of footwear (2 to 5 cm).
- Seatpan width corresponds to the 95th percentile of anthropometric parameter “hip width” in women.
- Seat depth in chairs without an adjustable depth is particularly important. This parameter should not exceed 41 cm to meet dimensions of 5th percentile subjects.
- Generally, backrests that only support the lower back are defined as “low.” Backrests supporting the trunk up to the maximum thoracic kyphosis are considered “medium,” while those which exceed this height are considered “high.”

When the backrest is height-adjustable, it should be at least 32 cm high, and its upper edge should be capable of reaching 48 cm from the seat plane.

- Backrest width: to properly satisfy the anthropometric parameters (considering the values for the 95th percentile male), the width should be at least 33 cm in the lower back segment, and 38 cm in the thoracic segment.

TABLE 21.1 Recommendations for the Adjustability of Chair Components and Corresponding Anthropometric Parameters

	Recommended Dimensional Range (cm)	Corresponding Anthropometric Parameters
Seat height	39–52	Popliteal height
Seat depth	39–55	Buttock popliteal length
Seat width without armrests	≥47	Hip width
Seat width + armrests	≥49	Hip width
Backrest height	32–50	Max kyphosis/seat plane height
Backrest width		
Lumbar region	≥33	Minimum width lumbar lordosis
Thoracic region	38	Max width at thoracic kyphosis
Armrest		
Height	16–23	Elbow height to seat plane
Depth	20–25	
Width	≥5	

TABLE 21.2 Main Characteristics for Chair Comfort

	Recommended Dimensional Range
Seatpan max concavity (from backrest)	≤10 cm
Curvature of front edge (radius)	4–12 cm
Seat plane angle (degrees)	3–10°
Lumbar support height from seat plane depth	17–28 cm
	3–5 cm
Backrest angle net angle	90–110°
Horizontal profile (radius)	40–80 cm
Padding	Semi-rigid
Covering materials	Porous to prevent sliding

Armrests are useful for supporting upper limbs while work is not being done, but it is not clear whether or not it is desirable to provide support for the arms. It might be appropriate for tasks in which typing is intermittent, otherwise it should be an optional feature. The length of the armrest should be at least 20 cm and no more than 25 cm in order to position the chair close to the desk.

Comfort

The chair should have such a shape and profile as to meet “body curves and sizes” of different users. In Table 21.2, main characteristics for chair comfort are given.

- The backrest adjustment control should allow the backrest to be set at any desired inclination, or at a wide range of preset inclinations (e.g., at 5 degree intervals).
- Backrests that incline only by putting pressure on them should be avoided (even those with adjustable resistance): blocking devices to fix desired inclinations are preferred.
- The front edge of the seat should be rounded. The curvature should have a radius between 4 and 12 cm and height of approximately 4 cm.
- The center of the seatpan concave section should be placed within 10 cm of the most protruding point of the lumbar support when the backrest is in its normal position.

Lumbar support height should be adjustable between 17 and 28 cm. The maximum protrusion for nonadjustable backrests should be fixed somewhere between 20 and 24 cm from the seat plane. The length of lumbar support should range between 20 and 30 cm for medium-sized backrests, and the shape should be vertically convex and horizontally concave.

TABLE 21.3 Recommendations for Desk, VDT Screen, and Keyboard

Recommended Dimensional Range	
Desk	
Surface height	72–75 cm
Surface width	150 cm
Surface depth	90 cm
Legroom	
Width	80 cm
Depth at knee	60 cm
Depth at feet	80 cm
Keyboard	
Slope	5°–30°
Thickness	3–5 cm
Screen height	90–110 cm

Practicality and Solidity

- Adjusting the chair's various components should be made as easy as possible for the user. If the controls are difficult to maneuver because they are hard to reach, nonresponsive, or require too much strength, they will never be used. The adjustment controls should be responsive, precise, and easy to reach from a seated or semi-seated position and should not require strength. Any knobs or handles should not come off easily.
- The solidity of the chair and its components is an essential requisite, not only from the marketing point of view, but also for ensuring continuous ergonomic performance over time.

Desk

The second important component of the VDT workstation is the desk. The height or work surface is the most discussed parameter since improper height leads to development of musculoskeletal problems and hinders a correct allocation of legs (ANSI, 1988). Also the use of an adjustable desk as opposed to a fixed one gives rise to controversial opinions. As previously mentioned, a fixed working surface height is a physiologically and economically satisfactory solution. In fact, with a fixed desk height of 72 to 75 cm, if a footrest is available for the lower stature operators, almost any postural combination which can be obtained with an adjustable desk, is possible. It has also been observed that most adjustable desks are quite often unstable, that operators very rarely adjust them, and that no significant difference in musculoskeletal problems has been found between adjustable and fixed-desk users (Hochanadel, 1995).

In Table 21.3 recommendations for desk, VDT screen, and keyboard are given.

Desk width and depth are very important factors not sufficiently investigated in the literature. A width of 150 cm minimizes the proper placement of all the working instruments, while a depth of 90 cm is essential for positioning the VDT in front of the operators; commercially available desks have a depth of 75 cm, which does not allow, considering the dimensions of VDT and keyboard, enough space in front of the desk for supporting at least half of the forearm and/or for writing tasks. In this condition, the operators usually move the VDT to the left or right side of the desk, and consequently adopt unnatural and unfavorable neck posture.

21.7 Organizational Factors

As underlined in the introduction, ergonomically designed workplaces avoid awkward and unhealthy postures but do not solve all postural problems. Some other aspects, such as psychosocial and biodemographic factors and individual characteristics, have an impact on VDT operators' comfort.

In addition, organizational factors like information and training, work duration, pauses, and job rotation, taken into appropriate consideration, can reduce fatigue and musculoskeletal disorders.

Information should be given to VDT operators on physiopathology of musculoskeletal disorders, how to sit correctly, how to properly adjust the workplace components, and how to reduce exposure to VDT work risk factors. However, information by itself gives poor results if operators are not well-trained and their learning is not verified. In other words, one must avoid giving oral information or informative booklets without checking that operators have well understood the contents and are able to put them into practice.

Job variety, task rotation, and breaks, as means to reduce the duration of fixed posture, are useful in interrupting the isometric tension of muscles required to maintain a mostly fixed posture. To prevent the possible consequences of postural fixity, VDT work must be designed in such a way that postural pauses are planned and used, in particular when work organization and times are for the most part fixed. In other situations, where the operators have higher levels of discretion in performing tasks, adequate information should be given on how to use the equipment, how to alternate work periods with pauses, and what to do during the pauses (Grieco, 1986).

The need for more dynamic activity to reduce the stress of sedentary work has given rise to a proliferation of exercise programs designed to reduce musculoskeletal discomfort from VDT work, both at work or before and after the workshift.

A review (Lee, 1992) of 14 exercise programs for VDT users with regard to the usability and physiotherapeutic/safety criteria showed that less than 50% of exercises were satisfactory, and could be easily performed at the workstation, without being embarrassing or significantly disrupting the work routine.

In addition, a number of exercises exacerbated biomechanical stresses common to VDT work or were even contraindicated for people with health problems. These conclusions indicate the need for great caution in suggesting physical exercises to VDT operators.

21.8 Conclusions

Physical attributes of VDT workplaces, organizational and psychosocial factors together with individual characteristics are recognized as potential risk factors for the musculoskeletal apparatus responsible for the diffusion of musculoskeletal disorders among VDT operators.

To be successful, a preventive approach should take into consideration all the risk factors in an integrated manner. The following 10 rules will help in minimizing the risks associated with VDT work.

1. Workplaces should be dimensionally designed to allow not only physiologically comfortable posture but also body movement for a wide variety of body types and dimensions (from 5th percentile female to 95th percentile male).
2. Adjustable chair and desk, with a proper footrest provide the best solution. Also an adjustable chair and a footrest with fixed desk height ensure numerous postural combinations to meet the variability of potential users, being, in addition, an economically satisfactory solution.
3. The chair is the most important VDT workplace component: for this reason it must have multiple adjustments, shapes, and profiles, to ensure adaptability and comfort. In addition, an adaptable and comfortable chair should be practical, solid, and safe in order to be easily adjustable from a seated position, capable of ensuring ergonomic performance over time and not being a cause of accidents.
4. Keyboard and non-keyboard input devices should facilitate neutral postures and avoid excess of force application.
5. Desk depth is a very important factor quite often overlooked; desk depth less than 90 cm hinders operators to position the VDT in front of them. Moving the VDT to the left or right side of the desk can frustrate all the efforts made for providing ergonomic workplaces.
6. Job demand, in terms of workload, work pressure, and workplace should conform to the individual resources in order to avoid psychological stress, which can increase the risk of musculoskeletal disorders.

7. Frequent breaks can reduce fatigue and musculoskeletal disorders. However, operators should know what to do during the pauses so that they do not remain seated, maybe reading a paper, having a work pause but not a postural (and visual) pause.
8. When the operator has little discretion in the operation performance, the job should be designed so that alternative postures and body mobilization are required.
9. Minimizing direct and indirect glare helps avoid awkward postures.
10. Information and training are essential for the successful implementation of ergonomic intervention. Information and training are aimed at introducing or modifying behavior in situations made up of real people. For this purpose, information and training should be integrated, and operators should be tested on their understanding of the content and their ability to put it into practice.

21.9 Summary

Musculoskeletal disorders among VDT operators are very diffused, even if the actual prevalence is not well known. The etiology is not well understood, but three factors appear to be mostly related to musculoskeletal disorders in VDT operators: task- and workplace-related factors, psychosocial factors, and non-task-related factors.

The risk factors and their effect on musculoskeletal apparatus are discussed, and recommendations on workplace and dimension characteristics are given. It is underlined that to be successful a preventive approach should take into account all the risk factors in an integrated manner.

This means that psychological and organizational factors, like workload, work pressure, work pauses, information, training, and individual characteristics should be taken into account together with workplace physical characteristics.

Acknowledgments

Thanks are due to Arch. P. Lavano for graphical assistance and computer drawings and to R. Manera for helpful support.

References

- American National Standards Institute, 1988. American National Standard for Human Factors Engineering of Visual Display Terminal Workstations. *The Human Factors Society*, Santa Monica.
- Armstrong, T. J., Martin, B. I., Franzblau, A., Rempel, D. M., Johnson, P. W. 1995. Mouse input and work-related upper limb disorders. *Work With Display Units 94*. p. 375-385. Elsevier Science B.V., Amsterdam.
- Barnes, W. S. 1980. The relationship between maximum isometric strength and intramuscular circulatory occlusion. *Ergonomics*. 23: 351-357.
- Bongers, P. M., Houtman, I. L. D. 1995. Psychosocial aspects of musculoskeletal disorders. *Premus95*. p. 172-174. IRSST. Montreal.
- Bridge, R. S. 1991. Some fundamental aspects of posture related to ergonomics. *International Journal of Industrial Ergonomics*. 8:3-15.
- Caillet, R. 1973. *Il dolore cervico-brachiale*. Leonardo Ed. Scientifiche. Roma.
- Cantoni, S., Colombini, D., Occhipinti, E., Frigo, E., Pedotti, A. 1984. Posture analysis and evaluation at the old and new workplace of a telephone company. in *Ergonomics and Health in Modern Offices*. p. 456-464. Edited by Grandjean, E., Taylor & Francis. London.
- Carayon, P. 1995. Work pressure as a determinant of job stress and cumulative trauma disorders in automated offices. *Premus95*. p. 172-174. IRSST. Montreal.
- Colombini, D., Occhipinti, E., Frigo, E., Pedotti, C., Grieco A. 1985. Biomechanical, electromyographical and radiological study of seated postures. *International Occupational Ergonomics Symposium*. Zara. 14-16 April.

- Dainoff, M. J., Mark, L. S. 1987. Task and adjustment of ergonomic chair. *Work with Display Units* 86. p. 294-302. Knave, B., Wideback, P. G. Eds., North-Holland, Amsterdam.
- Drury C. G., Coury, B. G. 1982. A methodology for chair evaluation. *Applied Ergonomics*. 13: 195-202.
- Drury C. G., Frencher, M. 1985. Evaluation of a forward sloping chair. *Applied Ergonomics*. 16:41-47.
- Edwards, R. H. T., Hill, D. K., McDonnell, M. 1972. Myothermal and intramuscular pressure measurements during isometric contractions of the human quadriceps muscle. *Journal of Physiology*. 224:58-59.
- Eklund, J. A. E., Corlett, E. N. 1984. Shrinkage as a measure of the effect of load on the spine. *Spine*. 9:189-194.
- Grandjean, E., Hunting, W., Piderman, M. 1983. VDT workstation design: preferred settings and their effects. *Human Factors*. 25: 161-175.
- Grieco, A. 1986. Sitting and posture: an old problem and a new one. *Ergonomics*. 29:345-362.
- Hagberg, M. 1995. The "mouse-arm syndrome" — concurrence of musculoskeletal symptoms and possible pathogenesis among VDU operators. *Work With Display Units 94*. p. 381-385. Elsevier Science B. V. Amsterdam.
- Hochanadel, C. D. 1995. Computer workstation adjustment: a novel process and large sample study. *Applied Ergonomics*. 26(5):315-326.
- Hunting, W., Laubli, T., Grandjean, E. 1981. Postural and visual loads at VDT workplaces I. Constrained postures. *Ergonomics*. 24:917-931.
- Klausen, K., Rasmussen, B. 1968. On the location of the line of gravity in relation to L5 in standing. *Acta Physiologica Scandinavica*. 72:45-52.
- Kraemer, J. 1977. Pressure dependent fluid shifts in the intervertebral disc. *Orthopaedic Clinics of North America*. 8:211-216.
- Lee, K., Swanson, N., Sauter, S., Wickstrom, R., Waikar, A., Mangum, M. 1992. A review of physical exercises recommended for VDT operators. *Applied Ergonomics*. 23(6):387-408.
- Lim, S. Y. 1995. Psychosocial and work stress perspectives on musculoskeletal discomfort. p. 175-177. *Premus95*. IRSST. Montreal.
- Mandal, A. C. 1991. Investigation of the lumbar flexion of the seated man. *International Journal of Industrial Ergonomics*. 8:75-87.
- Nachemson, A. 1976. The lumbar spine: an orthopaedic challenge. *Spine*. 6:93-302.
- Nachemson, A. 1968. The possible importance of the psoas muscle for stabilisation of the lumbar spine. *Acta Orthopaedica Scandinavica*. 39:47-57.
- Occhipinti, D., Colombini, D., Molteni, G., Grieco, A. 1993. Criteria for the ergonomic evaluation of work chairs. *La medicina del lavoro*. 84:274-285.
- Ogata, K., Whiteside, L. A. 1981. Nutritional pathways of the intervertebral disc. *Spine*. 6:211-216.
- Pearce, B. 1995. An alternative perspective on the VDT health hazards debate: folk hazards and health panics. *Work With Display Units 94*. p. 15-20. Elsevier Science B. V., Amsterdam.
- Pheasant, S. T. 1986. *Body Space*. Taylor & Francis Ltd. Philadelphia.
- Silverstein, B. 1986. Carpal tunnel syndrome: Causes and a preventive strategies. *Seminars in Occ. Med*. 1:213-219.

For Further Information

Ergonomic Aspects of Visual Display Terminals. E. Grandjean and E. Vigliani. Eds., Taylor & Francis. London 1980. Proceedings of the First International Workshop on "Ergonomic Aspects of Visual Display Terminals," Milan, Italy. March 17-19, 1980.

Ergonomics and Health in Modern Offices by E. Grandjean. Ed., Taylor & Francis. London and Philadelphia, 1984. Proceedings of the International Scientific Conference on Ergonomic and Health Aspects in Modern Offices, held in Turin, Italy. November 7-9, 1983, under the auspices of the International Ergonomics Association, the Permanent Commission and International Association of Occupational

Health, the University of Turin, the Società Italiana di Medicina del Lavoro e di Igiene Industriale and the Regione Piemonte.

Ergonomics in Computerized Offices by E. Grandjean. Taylor & Francis. London and Philadelphia, 1987. This book is a milestone by an early pioneer in researching human capabilities and limitations within industry, and applying that knowledge to the design of industrial work situations.

Work With Display Units 86 by B. Knave and P.G. Wideback. Eds., Elsevier Science B.V. North-Holland, 1987.

Work With Display Units 89 by L. Berlinguet and D. Berthelette. Eds., Elsevier Science B.V. North-Holland, 1990.

Work With Display Units 92 by H. Luczak, A. Cakir and G. Cakir. Eds., Elsevier Science B.V. North-Holland, 1993.

Work With Display Units 94 by A. Grieco, G. Molteni, E. Occhipinti, and B. Piccoli. Eds., Elsevier Science B.V. North-Holland, 1995. Selected papers of WWDU Conferences are published by Elsevier Science B.V. These selected papers document the latest developments in the field of work with display units.

22

Human–Computer Interface Requirements

22.1	Introduction	22-1
	General • Should System Designers Adhere to Human–Computer Interface Standards? • The Systematic Approach: Focusing on Tasks Rather Than on Products	
22.2	Requirements Based on ISO 6385	22-4
22.3	Requirements and Recommendations of ISO 9241	22-5
	The Approach of ISO 9241 • Coverage of ISO 9241 • Requirements and Recommendations for Displays and Input Devices • Requirements and Recommendations for Software	
22.4	Future Requirements for the U.S.	22-17
22.5	Conclusion	22-18

Ahmet Çakir
*Ergonomics Institute
Berlin*

22.1 Introduction

General

Human–computer interaction is a frequently used but not adequately defined term. The main reason for this may be found in the rapid changes of forms of human–computer interaction over time. While some users still remember pushing buttons on the housing of a computer to enter hexadecimal codes, other users expect computers to respond simply to their gestures. Even barring these extremes, a great variety in the way of interacting with computers remains: while some users work with computers using a simple keyboard and a single screen, others utilize highly sophisticated input/output media and multiple screens. Moreover, the workstation, formerly being the “terminal” (or “end station”) of a single computer, may today be used for simultaneous access to networks that may be distributed over the entire world. Thus, while formulating requirements in the human–computer interface, a great diversity of tasks need to be considered as well as user populations with considerably different characteristics.

For defining and confining the term “requirement,” different approaches can be taken, e.g., relying on one’s own expertise, deriving them from consistent guidelines, for example, Smith and Mosier (Smith and Mosier 1986), or drawing conclusions from relevant literature. The latter approach was taken by expert groups who prepared the standard ISO 9241 after almost a decade of discussions. Our recent experience with the application of this standard for testing workplaces in German industries suggests that most user requirements are covered by the provisions of ISO 9241. Thus, this section will concentrate on this standard with its 17 parts. However, part 1 will not be addressed since it gives introduction to other parts of the standard. Part 2 will also not be addressed due to the objective of this part which is giving guidance on task design.

The entirety of “normative documents” applicable to human–computer interface design goes well beyond ISO 9241. Various organizations throughout the world are involved in creating new normative documents (see below) of different nature and legal relevance, an ongoing process which is described in Smith (1996) with focus on international standardization and U.S. involvement. For project managers who want to integrate ergonomics within the activities for designing or redesigning interactive computer systems, the future standard ISO 13 407 will provide guidance for human-centered design of such systems.

Should System Designers Adhere to Human–Computer Interface Standards?

A “standard” in general is a set of normative rules applicable to single products, systems, services, or even behavior of organizations, to name the most important. They represent a consensus met within a trade or business area, in a country or in an international context. Although there is no obligation for written standards, in today’s world, standards are documents which result from an agreement by a group of sanctioned persons. In most countries, standards are established by private organizations, and their use is voluntary unless they are legislated.

Both the growth of world trade and communication amplified the need for international agreements in the form of standards. However, such agreements may be of different quality and, most important, flexibility. While some standards specify all relevant features of the object in question, e.g., the transmission quality of a telephone line, others may give guidance similar to a code-of-practice. Some standards even simply serve as documents of “understanding:” they describe their objective, but they do not contain any requirement or recommendation concerning this objective. Since this understanding of standardization is not common in the international community, e.g., the word “standard” may be perceived differently in the U.S. and Europe, the role and nature of standards may be misunderstood also. For example, Smith and Mosier (1986) make a distinction among standards, guidelines, design rules, and algorithms as means for design guidance, with the standards being the most rigid. For example, with regard to “aids for tailoring,” the provisions of standards are declared as “none,” while algorithms “might have optional parameters.” The conclusion of the authors is: “Our present knowledge supports development of flexible design guidelines for user interface software, but does not justify imposition of standards.”

Today, more than 10 years later, our widely improved knowledge still does not support the imposition of standards in the rigid understanding of the word “standard;” however, the lesson learned from the past is that any rigid standard based on design parameters or technical features will always fail since it will be subject to aging (see “The Approach of ISO 9241”). The standards in question are even more flexible than guidelines from the past. The surprising effect of the new approach in standardization is that system developers are often disappointed by the lack of mandatory requirements concerning their specific object of interest. There are still various good reasons for observing the rules set by the standards without adhering to their perceived nature as “mandatory and rigid” rules. The main reasons for this are:

- The standards described here represent the result of an agreement within the international community.
- They focus on user comfort and performance rather than on product features (human-centered approach instead of product-centered).
- They allow developing different methods of evaluating usability of systems on the basis of a consistent method.
- They do not prefer any technical solution, and, thus, are friendly toward diversity.
- To demonstrate compliance with legislation, now existing in Europe, thinkable for many countries outside this region, will only be possible on the basis of standards.

ISO 9241 replaced the first national standard on human–computer interface, DIN 66 234, in Germany. The European standardization will accept it as unique standard for this area. For the U.S., a future standard (ANSI/HFS 200) comparable with ISO 9241 is in preparation. It must be noted, however, that the focus of ISO 9241 is usability, and usability is only one of many quality criteria for software and system design.

The Systematic Approach: Focusing on Tasks Rather Than on Products

From the perspective of work system design, human-computer interaction does not constitute the primary design goal. In the development of work systems, the first phase is their specification regarding the system task, i.e., the entirety of all activities required to achieve the intended outcome of the work system. In the second phase, the necessary system functions are allocated to machines and humans with some of these functions to be performed with human-machine interaction. Those functions allocated to humans and those to be performed with human-machine interaction constitute the work task of the user. The starting point for the human-computer interface requirements is the work task. This means that such requirements can only be formulated or justified on the basis of task requirements. Following this undisputed rationale, the starting point for the most elaborate standard on human-computer interface, ISO 9241, is the task itself (see ISO 9241-2, Guidance on Task Requirements).

Although the approach seems obvious, its application to system or software development is not easy since many tasks “emerge” after the software is introduced and users of a certain system may perform different tasks with it (e.g., intended usage, customizing, or maintenance). Companies developing their own software or software for the market are interested in product features rather than in analyzing task requirements. Thus, their interest focuses on usage-independent criteria. Following this rationale, some existing sets of requirements, e.g., “style guides,” checklists, etc., consist of descriptions of features without a specific consideration of the user’s task. To some extent, such requirements can be justified if their objectives are user and usage independent, e.g., “Error messages shall give information on how to recover from the error state.” However, limiting the term “information” in this requirement is task and user dependent, thus making it difficult to specify a requirement on the extent of the error message.

For the reason given above, the requirements formulated by different groups of people display a great diversity, e.g., a list of requirements set up by the manufacturer of certain products can be very specific, while requirements of international standards need to be generic and technology independent. To satisfy this need, the requirements of the International Standard 9241 are based on the “performance” approach, i.e., they specify the goals to be achieved by the use of a product rather than the features to be realized to reach that goal. In practice this means, however, an operationalization of the standard is needed. Most of the standards of the series ISO 9241 and none of the standards on software contain requirements. Instead, they give recommendations. For one of them (ISO 9241-14 on menus), the procedure of operationalization is described as follows (Harker, 1995): “If a product is claimed to have met the applicable recommendations in ISO 9241-14, the procedure used in establishing requirements for, developing, and/or evaluating the menus shall be specified. The level of specification of the procedure is a matter of negotiation between the involved parties.” The same applies to other parts of the standard that contain no requirements.

In general, the recommendations in ISO 9241 are formulated as guidelines, e.g., “dialogue principles” (see ISO 9241-10). However, those recommendations are turned into legal requirements for the so-called “operator/computer interface” by the EU-Directive 90/270/EWG (so-called “VDT-Directive”), valid for all countries of the European Union. This Directive requires that “the principles of software ergonomics must be applied, in particular to human data processing.” The requirements of the Directive themselves are even less specific than those of the standards; nevertheless, they are valid legal requirements for all workplaces with computers with a small number of exceptions.

Some important human requirements cannot be found in standards or other regulations on computer applications but elsewhere since they are generic for human work, and not only for computerized work. In some respects, it is claimed, some relevant criteria for human work have been “forgotten” while formulating software-related ergonomic standards or guidelines. One of the sources for relevant information on designing systems is ISO 6385, which constitutes the general framework for all ergonomic standards. From this standard, a number of directly applicable requirements for the human-computer interface can be derived although it does not refer to computerized work.

22.2 Requirements Based on ISO 6385

Unlike most sources of requirements which focus on the “user” and “usability,” ISO 6385 states “The observance of ergonomics principles applies not only to the intended use of equipment, but also to its installation, adjustment, maintenance, cleaning, repair, removal, and transport.” This is clearly a systems-oriented approach that considers all those involved with the utilization of a product and not the intended users only. The importance of this approach can easily be understood by people responsible for PC applications, for whom the effort and costs for installation, customizing, updating, deinstalling, etc., go well beyond the price of the application, and where the workload of persons responsible for accomplishing such tasks is much higher than that of the intended users.

The requirements concerning the human–computer interface derived from this statement of ISO 6385 are as follows:

- The human–computer interface of a system shall be evaluated for all persons involved in the utilization of a computer system, and not for the intended users only.
- While designing the human–computer interface of a system, all tasks associated with different phases of the life cycle shall be considered, and not the phase of the usage by the intended users only.

Prior to the design of the human–computer interface, the work task should be considered, e.g.:

1. Recognize the experience and capabilities of the working population.
2. Provide for the application of an appropriate variety of skills, capabilities, and activities.
3. Provide people with an appropriate degree of autonomy in deciding priority, pace, and procedure.
4. Provide sufficient feedback in meaningful terms to those performing the task.
5. Provide opportunities for the development of existing skills and the acquisition of new skills with respect to the tasks concerned.

One important consequence of giving priority to task design over interface-related issues is that even highly complex interfaces can be considered ergonomic if the task at hand itself is complex. In other words, task adequateness takes precedence over ease of use. Following this rationale, various requirements can be derived from ISO 6385, e.g.:

- re 1. The design and use of relevant elements of the interface (e.g., screen layout, input/output language, graphical representations of objects, form and contents of help information, response times, etc.) shall take the existing knowledge of the intended users and their capabilities into account.
Note: Taking into account does not necessarily mean the designers should stick to what is already known to the intended users. Carroll and Olson (1991) describe two experiments in which the prospects of such an approach were tested. The successful strategy was that designers evaluated the input from the potential users and made their own decisions.
- re 2. Applications shall be sufficiently flexible to accommodate a variety of user needs depending on their skills, capabilities, and activities, e.g., users can select different styles of interaction.
- re 3. The interface shall permit the users to control their application efficiently.
- re 4. Each user action shall be followed by an adequate feedback.
- re 5. The interface shall be designed to promote learning; e.g., by making user actions reversible, and thus encouraging them to learn by trial-and-error.

As can be seen from these examples, the general requirements of ISO 6385 can be broken down to more specific requirements which go well beyond concepts that consider the intended users only. By an adequate interpretation of the entirety of ISO 6385, systematic sets of rules for both the software and its interface can be derived.

TABLE 22.1 Three Types of Performance

Meaning	Example
Behavior of an object	The selected menu option is echoed at the display as highlighted.
Process conducted by the user	The user discriminates available and unavailable menu options.
Success a user should achieve	A user is able to select the intended menu option within a menu panel.

22.3 Requirements and Recommendations of ISO 9241

The Approach of ISO 9241

The requirements of ISO 9241 are mostly defined in terms of “performance” instead of attributes (Çakir and Dzida, 1997). Performance has a threefold meaning (see Table 22.1).

The rationale behind the performance-based approach can be explained using the second example: the performance requirement stipulates that the user be able to discriminate available and unavailable menu options. A technical standard or a style-guide would require “graying out the unavailable options.” This requirement would, however, become obsolete when a designer finds a better way of discriminating the state of the menu options. Standards based on attributes rely on technical properties and are therefore subject to aging since aging is the most prominent feature of technology. Moreover, such standards are likely to impede the creative potential of designers. Mainly for these reasons, ISO 9241 describes goals rather than means.

Coverage of ISO 9241

ISO 9241 covers all topics related to the human-computer interface including task design, hardware (screens, input devices), software, and work environment. Some parts provide general guidance to be considered in the design of equipment, software, and tasks, while other parts include more specific design guidance and requirements. Since covering a wide range of information within a single standard was considered impractical, the topics were broken down to 17 parts, out of which 7 deal with software issues (see Table 22.2); some others have some relationship to software, e.g., part 8 on displayed colors. Each part of ISO 9241 is formally a separate standard. The numbers of the different parts of ISO 9241 do not reflect its structure since this was changed occasionally. The original objective of the standard was to provide requirements for the displays, the keyboard, and the workplace. Later, the objective was expanded to cover task requirements, work environment, and software-related issues. The need to cover usability as a general aspect led to the introduction of a specific standard (part 11).

The parts of ISO 9241 can be assigned to three groups dealing with (classification after Çakir and Dzida 1997):

- Work, organization and their role in usability specification (Parts 2 and 11)
- Workplace and work environment (Parts 5 and 6)
- Interactive equipment/tools
 - Parts 3 and 7 (on visual displays)
 - Parts 4 and 9 (on input devices, keyboard, and non-keyboard input devices)
 - Parts 10 and 12 up to 17 (on software interfaces)
 - Part 8 (on color, both for visual displays and software)

This classification is based on the overall nature of each part from a systemic point of view that considers hardware, software, and their interaction as a whole. For example, part 3 dealing with visual display requirements requires primarily the consideration of hardware features (monitor); however, fulfilling visual display requirements as described in this standard requires the consideration of software,

TABLE 22.2 Parts of ISO 9241 and Their Status as of September 1998

Part	Title	Status ¹
1	General introduction	IS, FDIS, second revision
2	Guidance on task requirements	IS
3	Visual display requirements	IS
4	Keyboard requirements	IS
5	Workstation layout and postural requirements	IS
6	Guidance on the work environment	DIS
7	Display requirements with reflections	IS
8	Requirements for displayed colors	IS
9	Requirements for non-keyboard input devices	DIS
10	Dialogue principles	IS
11	Guidance on usability	IS
12	Presentation of information	FDIS
13	User guidance	IS
14	Menu dialogues	IS
15	Command dialogues	IS
16	Direct manipulation dialogues	DIS
17	Form filling dialogues	IS

¹ IS = Standard; DIS = Draft International Standard;
FDIS = Final Draft International Standard

also. The same applies to keyboards and to non-keyboard input devices if the focus of interest lies on performance and comfort.

If the main focus of each part is of interest, the structure of the standard may be seen as follows:

- Parts dealing *mainly* with *hardware concerns* include: visual display requirements (3), issues related to reflections (7), keyboard (4), workstation layout and posture (5), and non-keyboard input devices (9)
- Parts dealing *mainly* with *software concerns* include: general dialogue principles (10), presentation of information (12), user guidance (13), menu dialogues (14), command dialogues (15), direct manipulation dialogues (16), and form-filling dialogues (17)
- Part dealing with the *use of color* (8), related both to hardware and software
- Parts dealing with *tasks and usability*: guidance on task requirements (2), usability (11)

The standards related to visual displays and input devices, to software, and to usability will now be discussed in greater detail.

Requirements and Recommendations for Displays and Input Devices

Requirements for Visual Displays

The requirements for visual displays are distributed over three parts of the standard, parts 3, 7, and 8. In addition, ergonomic requirements for the use of flat panel displays are regulated in a separate standard (ISO 13406). Although the title of part 3 is “Visual display requirements,” displays conforming to this standard do not necessarily meet all needs of users of visual displays. For example, part 3 does not deal with an important issue, the anti-glare treatment of the screen surface. In addition, some relevant characteristics of displayed images, e.g., the character size, have been standardized on the basis of research on monochrome character images. A number of experiments have shown, however, that legibility is lower for color displays (see Widdel and Post, 1992). Thus, character sizes for such displays must be larger than on monochrome displays. This is considered in part 8 of the standard. (See “Requirements for displayed colors.”)

The performance requirement for Part 3 is “that VDTs shall be legible, readable, and comfortable in use.” Conformance with this standard can be demonstrated either by meeting the design requirements

given in the standard or by passing the comparative user performance test which forms an informative annex. Part 3 contains design requirements related to the following topics:

- Flicker (as temporal instability and jitter as spatial instability)
- Legibility (design viewing distance and character height, as well as character design (stroke width, width-to-height ratio, between-character, -word, and -line spacing, linearity, and orthogonality))
- Luminance (display luminance, luminance contrast and balance, image polarity, luminance uniformity, and coding)

The comparative user performance test reflects the approach of ISO 9241 following which any device equal to or better than another device complying with the standard is also in compliance with it. The compliance is demonstrated by passing the test which compares the device under consideration with a reference by means of user performance and comfort, the performance requirements of ISO 9241-3. Currently, the test method is informative. However, it will become normative after revision. Although the test method was introduced for formal testing, it can be extremely useful for other purposes, e.g., for testing different fonts on the same screen or for comparing the legibility of the same font on different displays, etc.

The measurement techniques needed for most of these design parameters are so complex that few laboratories are able to measure them. Measurements with less qualified equipment are likely to yield wrong results. Consequently, it is not advisable to check the reliability of the measurements performed by laboratories. It is more promising to check whether the performance requirement is met under the conditions of the specific workplace(s) because most items addressed in this standard can be affected either by the operating system, the application, the font used, or the graphic board, or they can be easily changed unfavorably by the user. In addition, the standard does not consider the optimum visual distance for office work which is approximately 600 mm (see ISO 9241-5). Instead, the design viewing distance of a display may be selected to 400 mm by the manufacturer. This means that the characters may not be legible at the actual reading distance.

The following design parameters of a visual display are influenced by the selected settings of the graphic board and should therefore be checked at the workplace:

Flicker: Most monitors allow the user to select the resolution of the image (e.g., 800×600 or 1600×1200 pixels) according to the requirements of the application at hand, but only if the display refresh rate is changed. In many cases, the refresh rate will be too low for a flicker-free image. ISO 9241 contains a formula for calculating the minimum refresh rate to meet the requirement for a flicker-free image for 90% of the intended user population. According to this formula, a refresh rate of approximately 72 Hz is needed for displays with a dark background (“negative” screens). If the background is light (“positive” screens), the refresh rate should be at least 80 Hz to achieve a flicker-free display. This means, for example, that many VGA-displays with 60 Hz do not comply with the standard.

Legibility related parameters: Many parameters that influence the legibility of alphabetic characters but also those with an effect on the visibility of graphical objects in general, (e.g., visibility of icons) depend on the actual settings of the graphic board. For a given font, even the contrast of the characters may be changed if some settings of the graphic board are changed. Under some circumstances this is even true for settings not related to character formation. The graphical representations that may be influenced or affected in any case are those generated by the operating system, e.g., menus, directory listings, icons, etc.

Checking a display at a certain workplace can be accomplished either visually or by performing a user test applying the method described in the standard. For checking the most important visual parameter for legibility, the character size, for compliance with the standard under the conditions of a specific workplace, the actual character size (in mm) is to be multiplied with 170. The result should be bigger than the actual visual distance, e.g., a character height of 3 mm is sufficient for visual distances up to 510 mm. For usual office workstations, the characters should have a height of 3 mm to 4 mm. The luminance contrast of character details (contrast ratio) shall not be less than 3:1 (part 3); however, it is not possible to measure this at the workplace with simple equipment.

Luminance: Issues related to the luminance of displays are addressed in parts 3 and 7 of ISO 9241. Part 3 requires the display be capable of a display luminance of at least 35 cd/m^2 . If luminance coding is used, 35 cd/m^2 specifies the minimum for the lower luminance. It is noted in the standard that operators often prefer substantially higher display luminance levels (e.g., 100 cd/m^2), particularly in conditions of high ambient illuminance.

The approximate luminance contrast can be calculated by measuring the display luminance when the screen is active and the background luminance caused by ambient light. The correct methods for measuring this feature are given in part 3 and part 7. The latter specifies the measurement including glare guarding (filters, treatment of the screen surface, etc.).

Part 7 of ISO 9241 deals solely with glare-guarding of the display. It proposes three classes of displays. Its performance criterion is that VDTs shall be legible and comfortable to use. The basic requirement is that the luminance ratio of the image, including superimposed specular and diffuse luminances shall be equal to or greater than 3, i.e., the minimum contrast ratio according to ISO 9241-3 shall be maintained under the lighting conditions at the workplace. Class I displays which comply with the requirement under the conditions specified in the standard (luminance of extended glare sources $\leq 200 \text{ cd/m}^2$, that of small sources $\leq 2000 \text{ cd/m}^2$) are considered suitable for general office use; classes II and III require a specially controlled luminous environment for use. Since the measurements required in part 7 cannot be performed at the workplace, possible actions of user organizations are limited either to selecting the appropriate class for the existing visual environment or to creating the environmental conditions for utilizing class II and class III displays (see ISO 9241-6).

No provisions are made in any standard for one of the most important design parameters of visual displays, their physical size. The same is true for the resolution of the monitor. This does not mean that there are no user requirements concerning these parameters. It must be noted, however, that it is extremely difficult to specify the needs of different user groups with different tasks. For the same reason, there is also no specification for the "optimum" paper size needed for office work. Instead, an "unofficial" standard exists stating that the size "A4" is to be used unless some other considerations suggest any other format. Even "A4" is not the same in all countries.

For computer applications with a character-based interface, a similarly informal standard for the display was found (25 lines with 80 characters each). The physical size of such displays is approximately 14 to 15 inches, ensuring a fair legibility under office conditions with character sizes between 3 and 4.5 mm depending on the actual size of the display area. The users do not have to bother about the screen resolution since the character generator is integrated in the monitor hardware.

For modern applications with graphical interfaces, however, the aspects to be considered are very different. Regarding the question of resolution, one can require the same resolution as on print. However, the current display technology for electronic displays is not suitable to meet such a requirement. While a satisfactory print medium (e.g., a laser printer) offers a resolution of 600 dpi, the usual screen resolution lies somewhere between 50 dpi and 80 dpi. Extremely good displays may offer 150 dpi or even 200 dpi. However, the bulk of existing computer displays rarely exceeds a resolution of 60 dpi. This means that a laser print contains one hundred times more picture elements than the average screen on an area of the same size. One square inch of laser print has more pixels than an electronic visual display with 640×480 pixels. Poor resolution constitutes one of the most important reasons for the poor readability of computer screens which was demonstrated by various authors (e.g., Wright and Lickorish, 1983; Gould et al., 1987). An overview of studies related to this issue was published by Dillon et al. (1988). Gould et al. demonstrated that the performance decrement vanishes if the overall quality of the electronic display including its resolution is improved. In general, research findings suggest that a higher screen resolution will improve both performance and comfort of the users.

Surprisingly, the vast literature on VDT use makes no mention of the required physical size of the display area although complex programs like Excel™ or Freehand™ may clutter up to one third of the available display with their rulers, palettes, etc. leaving a small proportion of the screen for the task. Although there is no requirement based on standards and also no evidence based on research, it is advisable to consider this issue while designing systems and workplaces. According to our experience,

applications running under Windows™ need a 17" display while applications that include document imaging require a monitor size of at least 21". For complex programs with various palettes, it is even advisable to use two screens.

Requirements for Displayed Colors

Part 8 of ISO 9241 deals with characteristics of displayed colors. However, the performance objective of this standard is not color use in general, but representation of data coded with color. The objective is obtained if colors can easily be detected, identified, and discriminated and if the assignment of meaning to color is appropriate to the task. The requirements of this standard are related to hardware as well as to software.

The standard requires a default set of colors for all applications that require the user to discriminate or identify colors. If the colors can be altered by the user, the default set of colors shall be retrievable and restorable. In general, the standard requires the number of colors presented simultaneously to be minimized. For accurate identification, the standard recommends that the default color set should consist of no more than eleven colors for each set. However, when a rapid visual search is required or the meaning of a set of colors is to be recalled from memory, no more than six colors should be used. Software applications that require the meaning of each color of a set of more than six colors to be recalled shall make the associated meaning of each color accessible.

For the size of images respecting height of characters, the standard requires different sizes depending on the relevance of the visual objects. For alphanumeric character strings, the character height shall subtend at least 20 minutes of arc, while for accurate color identification of a single object (a character or a symbol), 30 minutes of arc is required as a minimum; 45 minutes of arc is recommended. The use of extreme blue should be avoided for small images subtending less than 2°.

The luminance contrast of multicolor displays shall conform to ISO 9241-3, i.e., they must have a contrast ratio of 3:1. Spectrally, extreme blue shall not be used on a dark background.

Requirements for Input Devices

The requirements for input devices are divided into two standards with ISO 9241 part 4 dealing with keyboards, and part 9 with other input devices (non-keyboard).

The provisions of ISO 9241-4 are for conventional (linear) keyboards, but they do not rule out that any other design can comply with the standard if it meets the performance requirement of this standard. To be usable for the designated purpose, i.e., if users can achieve a satisfactory level of keying performance on a given task and maintain a satisfactory level of effort and comfort. The objective is obtained either by meeting the design requirements of the standard or passing the usability test for data or text input or both. The layout of the keyboard is not regulated in this standard but in ISO 9995. However, one important issue for user organizations throughout the world, the layout of the numeric keypad vs. the layout of touch telephones, has been solved: ISO 9241-4 recommends the telephone layout also for computer keyboards.

Most provisions of ISO 9241-4 are addressed to the manufacturer, e.g., the use of graphical symbols, durability of legends throughout the intended life of a product or a matte finish of the keys for better legibility. Given the fact that the matchless price war in the computer business forces the manufacturers to reduce costs wherever possible, user organizations should demand that the keyboards offered them comply with this standard.

For user organizations, the most important provisions of the standard are:

- **Minimum footprint:** The overall dimension of the keyboard should not exceed the minimum space determined by the number of keys needed for its designated purpose and by the requirements for grouping the keys.
- **Low profile:** The height of the keyboard should be 30 mm or less and shall not exceed 35 mm.
- **Ease of placement:** The design of the keyboard shall permit it to be easily repositioned on the work surface. The keyboard shall be detachable except for special applications with clearly defined tasks.

- Adjustability: The keyboard should be adjustable in slope.
- Legibility of legends: All legends on keys shall be legible from the design reference position, i.e., users should not be forced to change their posture to view the key legends.
- Cursor keys: Keys for the control of cursor movement shall be provided.

ISO 9241-4 together with ISO 9995 aims to ensure that keyboards used in a given country have a uniform layout, a certain quality for keying performance, and standardized use of symbols.

For other input devices, relevant requirements will be formulated in ISO 9241-9. The purpose of this standard is to formulate generic requirements for any input device including future devices, and to formulate specific requirements for existing devices.

Requirements and Recommendations for Software

Introductory Remarks

Seven parts of ISO 9241 (10, 12 to 17) are dedicated to software issues. As explained above, they will not contain requirements. However, the recommendations given in each part can be converted to requirements by applying the method described in part 11. All parts from part 12 contain a checklist including all recommendations of each part and guidance on applying the method of part 11 to the specific topics of the part under consideration. In addition, for the countries of the EU, the VDT-Directive may establish a legal status for the provisions of the standard (see “Relationship Between Dialogue Principles and Legal Requirements”).

One of the main reasons for not including requirements in some parts of ISO 9241 lies in the ISO Regulations which demand that any requirement shall be accompanied by sufficient information on how to comply with it. In general, this is a method for measurement and a statement on conformance. For example, if a standard requires a certain length of an object, a measurement method (e.g., ruler, microscope) shall be specified. The statement of conformance could be “Objects of a length of 20" \pm 0.05" comply with the requirements of this standard.” Given the fact that today such demands cannot be met even for technical issues related to software, it is impossible to formulate mandatory requirements for ergonomics of software and applications within the ISO framework.

In other regulations, it is permissible that requirements can be formulated without specifying the means for demonstrating compliance with them. For example, the IEC-standard on the application of visual display units in the main control rooms of nuclear power plants requires: “Information shown on VDU shall be clearly understood in any operating conditions” (IEC 1772, 1995). The standard does not contain exhaustive and precise methods for measuring “information” and “understanding.” Instead, it refers loosely to an annex of the main standard on the design for control rooms of nuclear power plants (IEC 964, 1989).

In such cases, however, a high conflict potential exists since involved parties of an agreement may interpret relevant items of a standard differently. For example, a former national standard required that the screen size be sufficient to display the information to be viewed simultaneously without providing further specification of the object to be viewed, however. The intention of the requirement was to prevent that screens designed to be viewed without scrolling or selecting pages would be broken down into smaller units because of insufficient display size. However, it was not intended to keep designers from placing different pieces of information in consecutive screens if this makes more sense than stuffing them into a single screen. The message of the requirement was not understood. Thus, it created various conflicts. Moreover, imprecisely defined and confined requirements are likely to cause even more trouble in an international standard than in a national regulation. Thus, the ISO Regulations are bureaucratic but also very helpful in avoiding conflicts in general. In the case of software, however, the conflicts may have been postponed or shifted from the standardization to users and software vendors. In the case of IEC 1772, the parties involved in utilizing VDUs in nuclear power plants need an agreement on the conditions under which the specific requirement is considered properly addressed by the system.

TABLE 22.3 Dialogue Principles of ISO 9241-10 and Their Definitions

Dialogue Principle	Definition
Suitability for the task	A dialogue is suitable for a task when it supports the user in the effective and efficient completion of the task.
Self-descriptiveness	A dialogue is self-descriptive when each dialogue step is immediately comprehensible through feedback from the system or is explained to the user on request.
Controllability	A dialogue is controllable when the user is able to initiate and control the direction and pace of interaction until the point at which the goal has been met.
Conformity with user expectations	A dialogue conforms with user expectations when it is consistent and corresponds to the user characteristics, such as task knowledge, education, experience, and to commonly accepted conventions.
Error tolerance	A dialogue is error tolerant if, despite evident errors in input, the intended result may be achieved with either no or minimal corrective action by the user.
Suitability for individualization	A dialogue is capable of individualization when the interface software can be modified to suit the task needs, individual preferences, and skills of the user.
Suitability for learning	A dialogue is suitable for learning when it supports and guides the user in learning to use the system.

A conflict potential exists at least for the European Union and its fifteen member states due to legal requirements on the human-computer interface. The EU-Directive 90/270/EEC (“VDT-Directive”) contains legal requirements concerning the visual quality of displays including the readability of characters on the screens and the stability of the image as well as the ergonomic quality of the “operator/computer interface” in general. In practice, the required quality can be achieved as a result of hardware features (e.g., quality of the monitor and graphic card, computing power of the system, and transmission capabilities of networks) and software features (e.g., features of the application and communication software, network software). In most cases, the overall quality will also depend on the interaction of soft- and hardware. Thus, meeting the legal requirements is a question of system design. The lack of agreed methods for demonstrating compliance with the legal requirements is likely to create conflicts.

ISO 9241 part 11, which gives guidance on usability, may help overcome possible problems. However, the guidance given in this standard is not exhaustive; the parties involved in utilizing computer systems also need an agreement on the basis of this standard.

Provisions of ISO 9241-10, “Dialogue Principles”

Part 10 of the standard provides ergonomic principles for dialogue design in general terms, that is, the principles are presented without considering situations of use, specific applications, and environments. These principles are intended to be used in specifications, design, and evaluation of dialogues. The standard provides guidance on principles but not on their application to product attributes. This task is taken care of in parts 12 to 17. The idea of breaking down the term “user friendliness” into principles stems from an early research work by Dzida et al. (1977) which formed the basis of the German standard DIN 66234-8. This standard introduced five of the seven principles of ISO 9241-10 under the same name.

The term “dialogue” instead of “software” was chosen to reflect the knowledge that the relevant characteristics of the human-computer interface are a result of software and hardware features and their interaction. “Dialogue” is defined as an interaction between a user and a system to achieve a particular goal.

The standard defines seven principles which are named and defined as displayed in Table 22.3.

For further guidance, each principle is explained by a number of examples, which are not meant as recommendations for real applications but as illustrations for possible implementations. The way in which each dialogue principle can be applied will depend on the characteristics of the intended users of a system, the tasks, the environments, and the specific dialogue technique used. Guidance on identifying relevant aspects of the users tasks and the environment of use is given in ISO 9241-11. Specific guidance on the application of these principles to techniques such as menus, command languages, direct manipulation, and form-based entry is given in ISO 9241 parts 14 to 17. However, the standard does not specify

TABLE 22.4 Applications of Dialogue Principles and Examples

Application of the Principle	Examples
	Suitability for the task
The format of input and output is appropriate to the given task and user requirements.	<ul style="list-style-type: none"> The precision of input is equal to the precision required by the task; e.g., if a line with an approximate length is to be drawn, the input can be accomplished by dragging the mouse. If the line must have a precise length and position, the relevant data can be entered by a suitable device (e.g., tablet or keyboard).
The dialogue supports the user when performing recurrent tasks.	<ul style="list-style-type: none"> The system allows sequences of activities to be saved and allows the user to reuse them (e.g., usage of self-defined macros or scripts).
Actions that can appropriately be allocated to the system for automatic execution are carried out by the system without user involvement.	<ul style="list-style-type: none"> System start-up procedures are automatically processed. If installing an application does not require the selection of options, all procedures related to this action are executed by the system.
	Self-Descriptiveness
Feedback or explanations are presented in a consistent terminology which is derived from the task environment rather than from system technology.	<ul style="list-style-type: none"> The technical terms used in the dialogue are those actually used in the specific field of application. An object has only one name; different objects are named differently. Abbreviations used in the dialogue stem from the specific field of application.
Feedback or explanations are related to the situation for which they are needed.	<ul style="list-style-type: none"> The dialogue system offers context-sensitive help.
The dialogue provides adequate feedback for all user actions.	<ul style="list-style-type: none"> Keying activity is echoed within the time period required for efficient eye-hand coordination. If an object is deleted, it disappears from the screen. If a requested action cannot be performed, the error message explains why and describes the actions needed for recovery.
	Controllability
It is possible to undo at least the last dialogue step for any reversible action, if the task permits.	<ul style="list-style-type: none"> The dialogue system offers the possibility of accessing deleted objects. The system offers the possibility of selecting the adequate number of steps for undoing.
The user can determine the point of restart if the dialogue has been interrupted.	<ul style="list-style-type: none"> After a system crash, the user can decide on certain conditions for restarting the dialogue (e.g., "revert to saved," use "save file" or just continue).
The level and methods of interaction can be selected to meet user needs and characteristics.	<ul style="list-style-type: none"> The system offers menus and accelerators for novice and experienced users. The system offers user selectable levels of detail in help to correspond to different levels of expertise.
	Conformity with User Expectations
Dialogue behavior and appearance within the system are consistent.	<ul style="list-style-type: none"> System status messages always appear on the same line.
Dialogues used for similar tasks should be similar so that the user can develop common task-solving strategies.	<ul style="list-style-type: none"> The same key or command is always used to terminate the dialogue. To activate an application in a system with different applications the user is always required to double click on the icon of the specific application. The function of the backstep key is the same in all system modes.
	Error Tolerance
Error correction is possible without switching the dialogue system states, where the task permits.	<ul style="list-style-type: none"> During an entry into a form the user can type over incorrect characters without going to an editing mode. During the use of a help facility explaining the error condition, the system state permits entries.

TABLE 22.4 (continued) Applications of Dialogue Principles and Examples

Application of the Principle	Examples
Error messages are explained to help the user in recovering from the error state.	<ul style="list-style-type: none"> • The error messages contain information on error occurrence, type of error, and possible methods of correction.
Suitability for Individualization	
The dialogue system allows the user to adapt it to her/his language and culture, individual knowledge and experience of task domain, perceptual, sensory-motor, and cognitive abilities. The system allows the users to set up operational time parameters to match their individual needs. The system provides different dialogue techniques for selected tasks.	<ul style="list-style-type: none"> • The mouse can be adapted for left- or right-hand usage. • The keyboard can be adapted for one-handed use. • The formats for time, date, and the count of weeks of the year are adaptable to the needs of users in different countries. • The speed of scrolling of windows can be selected by the user. • The system allows the user to start a dialogue function either by entering a command or selecting a menu option.
Suitability for Learning	
Relevant learning strategies are supported by the system.	<ul style="list-style-type: none"> • Interactive online tutorials support learning by doing. • Dialogue steps can be reversed (“undo”) unless the user is warned (support for learning by trial-and-error).
The use of the system takes advantage of what the users already know.	<ul style="list-style-type: none"> • “Population stereotypes” are considered in the design of screens, control buttons, and other visual elements. • Metaphors from everyday life are used to convey the meaning of new functions to the user (e.g., envelope for e-mail).

whether any of these techniques is preferable over others in general terms. Instead, each standard specifies the conditions under which the particular dialogue technique or style is considered appropriate.

Table 22.4 gives some examples for each principle to illustrate how it can be applied. The examples are not exhaustive. The same is true for the examples in the standard. Their sole purpose is to show what is meant by the specific principle.

Relationship Between Dialogue Principles and Legal Requirements

Although ISO 9241-10 provides no requirements, it has generated some important legal implications. These implications are not caused by the legal status of the standard itself or by its contents but by the lack of further normative documents with requirements on the same subject. First, in many countries of the world, legal requirements exist forcing product designers to consider the “state-of-technology” or “state-of-the-art.” In these countries, software manufacturers may be held responsible for not considering the provisions of ISO 9241-10 since this standard may be considered “state-of-the-art.” Second, in the member states of the EU, the “VDT Directive” requires taking into account principles closely related to the dialogue principles of ISO 9241-10 in designing, selecting, commissioning, and modifying software, and in designing tasks. Since there is no other normative agreement on the corresponding requirements of the VDT-Directive, it is likely that ISO 9241-10 may be used instead. These requirements are directed to the employers, who try, however, to pass the unpleasant task to the manufacturer by asking for a statement that the specific product is in compliance with the requirements of the Directive. Even if the employer is reluctant to do this, she or he may be forced by the employees who have the right to reject new applications that do not conform with legal requirements. Moreover, employers who are reluctant to observe the mandatory rules may be fined or even sentenced to prison. While such an event is extremely unlikely, the most probable effect may be delays in the introduction of new systems and more bureaucracy. The best solution would be an agreement between the involved parties on how to take into account the relevant items.

For the time being, there is no formal relationship between the dialogue principles of ISO 9241-10 and the principles of the VDT-Directive. The following listing shows the correspondence of the principles:

Principle of the Directive 90/270/EEC	Dialogue principle of ISO 9241-10
Software must be suitable for the task.	Suitability for the task
Software must be easy to use and, where appropriate, adaptable to the operator's level of knowledge or experience;	Suitability for individualization
No quantitative or qualitative checking facility may be used without the knowledge of the workers.	Conformity with user expectations
Systems must provide feedback to workers on their performance.	No correspondence
	Suitability for learning
	Self-descriptiveness
	Controllability
Systems must display information in a format and at a pace which are adapted to operators.	Suitability for individualization
The principles of software ergonomics must be applied, in particular to human data processing.	Suitability for the task
	All principles

As can be seen from the correspondence list, all principles of ISO 9241-10 are subject to legal requirements within the EU, though, with a reference to tasks. In addition, no method for demonstrating conformance is specified. This gives each country the freedom to define under which circumstances a system can be assumed to comply with the Directive. For Germany, a set of rules is in preparation which is formulated in consideration of ISO 9241-10 (VBG, 1995). For formal reasons, these rules are titled as "Accident Prevention Rules" which is the official name for (mandatory) regulations for health and safety. The most important function of these rules is limiting the application of ergonomic principles to certain aspects specified within the framework of the regulation, thus enabling vendors and user organizations to set up procedures for checking their software and applications.

In areas where such rules do not exist, rules for testing software can be formulated after the guidance given in ISO 9241-11 and in consideration of parts 12 to 17 of ISO 9241. It should be noted, however, that a product has no intrinsic usability, only a capability to be used in a particular context (ISO 9241-11). Thus, usability cannot be assessed by studying a product in isolation. In this respect, there is no difference between usability and other quality criteria.

In addition, it should be noted that usability is only one criterion for software quality and other quality criteria defined in ISO/IEC 9126, such as functionality, reliability, and computer efficiency all contribute to the quality of the work system in use.

Recommendations for Presentation of Information (ISO 9241-12)

This standard provides information relevant for all dialogue techniques in three general categories: organization of information, design of graphical objects, and coding techniques. Even though the standard is for software, the information it provides may be useful to a great extent for anyone presenting information or preparing documents. For the evaluation of products, the users of the document can utilize the procedures provided as an annex.

An overview of the recommendations of the standard and their relationship to attributes of presented information is given in Table 22.5. For each item, recommendations are given. The method given for the use of the standard specifies recommended methods for assessing the applicability of each item in consideration of the task and a corresponding method for the evaluation of compliance. For the evaluation of a product, the compliance of the applicable items is to be evaluated, e.g., for applications without windows, the items on windows do not need to be evaluated.

Since presenting information constitutes one of the basic "technologies" for all human civilizations, the standard is not exhaustive. However, an annex provides lists of references sorted for each topic for further information. For designers who need specific information on the interface design for graphical user interfaces, useful information is given by Galitz (1994). Useful information on how to present information on paper and online is given by Horton (1991).

TABLE 22.5 Relevant Attributes of Presented Information and the Specific Ways to Present Information

Attributes of Presented Information	Provisions of ISO 9241-12, Specific Ways to Present Information
Clarity (the information content is conveyed quickly and accurately)	Windows, Location of information
Discriminability (the displayed information can be distinguished accurately)	Areas Input/output area
Conciseness (users are not overloaded with extraneous information)	Groups
Consistency (the same information is presented in the same way throughout the application, according to the user's expectation)	Lists Tables
Detectability (user's attention is directed toward information required)	Fields, Labels General recommendations for graphical objects
Legibility (information is easy to read)	Cursors and pointers
Comprehensibility (meaning is clearly understandable, unambiguous, interpretable, and recognizable)	Syntactic aspects of alphanumeric coding Semantic aspects of alphanumeric coding Abbreviations Graphical coding Color coding, Markers Coding with other visual techniques

Recommendations for User Guidance (ISO 9241-13)

Part 13 of ISO 9241 provides recommendations for user guidance attributes of software interfaces and their evaluation. It also is applicable to interaction components that aid users in recovering from error conditions. The provisions of this standard may be applied to all dialogue techniques. Most of the recommendations of this standard could also be requirements because they are technology and user independent, and express the presumably best way of guiding the user in the specific context.

Recommendations are given for

- Common guidance (e.g., phrasing of user guidance)
- Prompts (e.g., generic vs. specific prompts, location of prompts, cues, etc.)
- Feedback (e.g., appropriate system response time, type of feedback)
- Status (e.g., continuous presentation of status information, conditions under which automatic presentation is needed)
- Error management (e.g., error prevention, error correction by the system, error management by the user, error messages)
- Online help (e.g., system-initiated help, user-initiated help, context sensitive help, help navigation)

For the evaluation procedure, no specific guidance for the assessment of the applicability of the items is given since most recommendations can be evaluated without using a specific method. In addition, the majority of the recommendations is likely to be found "applicable." Assessment of compliance can be accomplished either by observing a representative user or by reviewing user guidance during self-use (walk-through).

Recommendations on Specific Dialogue Techniques (ISO 9241-14 to 17)

The last four standards in the series deal with particular dialogue styles, namely, menus, commands, direct manipulation and form-filling. Each standard provides information on the conditions under which the particular style is considered appropriate (user and organizational characteristics, task requirements, and system capabilities) and recommendations for this style. Actual design processes may be different, though. Complex applications regularly employ two or more of these styles. Thus, testing them for compliance may form a task for which all four standards need to be considered.

Part 14 (menu dialogues) provides information covering various features of menus including windowing, panels, buttons, and fields. The recommendations relate to interaction design or input/output design, e.g., placement of menu structure, levels, grouping options, syntax rules for textual and graphic

options. In some respects, the provisions of part 14 overlap with those of part 13 which is not surprising since interaction and input/output design under consideration of graphical rules and means always aim at guiding the user visually.

Recommendations are given for

- Menu structure (e.g., structuring into levels, grouping options within a menu, sequencing options within groups)
- Menu navigation (e.g., navigational cues, rapid navigation)
- Option selection and execution (e.g., selection methods, minimizing keystrokes, using function keys)
- Menu presentation (e.g., option accessibility and discrimination, placement, consistency of layouts, text option syntax, graphic option structure and syntax, auditory option structure and syntax)

The application of the standard by designers, procurers, and evaluators is described in an annex.

Part 15 (Command dialogues) provides information covering ergonomic aspects of command dialogues and gives guidance on when to use this dialogue technique (user characteristics, task requirements). The consideration of system capabilities is absent from the condition list since this dialogue style is usable even with “dumb terminals.” It must be noted, however, that this style is recommended if extensibility of a system is required for which it is the only available dialogue form.

Recommendations are given for

- Structure and syntax (e.g., internal consistency, command macros, argument structures)
- Command representation (e.g., command names, abbreviations, function and hot keys)
- Input and output considerations (e.g., command reuse, command queuing, defaults, customization)
- Feedback and help (e.g., command acceptance, error feedback, error highlighting, long parameter lists)

This part of ISO 9241 provides extensive information on compliance methods, which is also applicable to other parts. The annex with the applicability and compliance checklist also gives guidance for applicable methods for assessment.

Part 16 (Direct manipulation dialogues) provides information covering relevant issues for direct manipulation, the most recent style in interaction with computers. The list of conditions describing when this style is considered appropriate is the longest of all standards; in particular, the system requirements are the highest.

Recommendations are given for

- General considerations (e.g., metaphors, appearance of objects, feedback, input devices)
- Manipulation of objects (e.g., pointing and selecting, dragging, sizing of objects)
- Manipulation of text objects (e.g., pointing and selecting, sizing of objects)
- Manipulation of windows (e.g., moving windows, sizing, scaling)
- Manipulation of control icons (e.g., indicating manipulation types, indicating user tasks)

Part 17 (Form-filling dialogues) provides information for one of the oldest styles of interaction. This style is considered appropriate for data entry tasks requiring input or modification of multiple data items.

Recommendations are given for

- Form-filling structure (e.g., visual coding, layout, fields, and labels)
- Input considerations (e.g., cursor movement, default values, alphanumeric entry, choice entries, control, validation criteria)
- Feedback (e.g., echoing, cursor position, field errors, transmission acknowledgment, feedback)
- Navigation (e.g., initial cursor position, movement between fields, tabbing, scrolling, form selection)

This part of ISO 9241 provides extensive information on compliance methods which is also applicable to other parts. The annex with the applicability and compliance checklist also gives guidance for applicable methods for assessment.

Guidance on Usability

In ISO 9241-11, the objective of designing and evaluating for usability is to enable users to achieve goals and meet needs in a particular context of use. Usability is to be measured in terms of user performance and satisfaction. Guidance is given on how to describe the context of use of the product (hardware, software, or service) and the required measures of usability in an explicit way as a part of a quality system. However, the standard does not detail all activities to be taken.

The components of usability are effectiveness, efficiency, and satisfaction. Effectiveness is defined as the accuracy and completeness with which users achieve specified goals. Efficiency represents the resources expended in relation to the accuracy and completeness with which users achieve goals. Both efficiency and effectiveness, are components of user performance, whereas satisfaction is defined as the freedom from discomfort and positive attitudes to the use. The context of use consists of descriptions of the users, goals, tasks, equipment (hardware, software, and materials), and the physical and social environments in which a product is used.

Guidance is given for

- Benefits and rationale of the usability assessment procedure
- Framework for specifying usability
- Specifying the context of use
- Usability measures (effectiveness, efficiency, satisfaction)
- Interpretation of measures
- Specification and evaluation of usability during design
- Specifying and measuring the quality of a work system in use
- Relationship to other standards (ISO 9126, ISO 9241 parts 10, 12 to 17)

ISO 9241-11 does not contain any provisions on the human–computer interface; it describes the methodological framework for applying the rest of the standard on work systems.

22.4 Future Requirements for the U.S.

Currently, standardized requirements for the user interface in the U.S. are provided by ANSI/HFS 100 standard from the year 1988 which covers hardware (displays, keyboards, furniture) and environmental issues only. This standard is under revision and will cover similar topics like ISO 9241 except for software interface issues. These will be covered by a new standard ANSI/HFES 200 which is intended to be a “Human Computer Interaction” (HCI) standard. The standard is likely to include (Smith, 1996):

- Software terminology
- Software usability
- Menu layouts
- Effective use of color
- Command syntax
- Graphical user interfaces
- Command line interfaces
- Voice input/output
- Special considerations for people with disabilities. (Smith, 1996)

The last two items have not been covered in other standards. While the voice input/output may be considered not a principal issue, the absence of special considerations for people with disabilities is a major flaw of existing standards in general.

Both U.S. standards are likely to be comparable with ISO 9241; however, the differences in the understanding of the term “standard” between different countries and the specific legal implications of standards in the U.S. may force the working committees responsible for the revision of ANSI/HFES 100 and for processing ANSI/HFES 200 to introduce some substantial differences.

In the U.S., the requirements of military applications formed the most important driving force for the development of ergonomics in general. In this connection, it should be mentioned that the type of computer we use today throughout the world, the universal programmable engine, was once created following ideas of the military. U.S. military standards have a long tradition and have influenced even civilian standards outside this country. One of the most important standards from this point of view is MIL STD 1472 “Human Engineering Design Criteria for Military Systems, Equipment and Facilities,” which formed a basis for many civilian standards including ANSI/HFS 100 (Smith, 1996). This and other military standards will play a role both by their existence for their area of application and by their direct and indirect contribution to civilian standards.

22.5 Conclusion

ISO 9241 provides the most extensive information on human–computer interaction or interface to be found in standardization. The entire standard represents the result of discussions on relevant interface issues since 1983 in the context of an international ergonomic standard. Unlike technical standards which are subject to change when their object, the technology under consideration, changes, ergonomic standards should remain constant. For this reason, the performance approach formed the main basis for this standard. Designers expecting statements on product attributes comparable to those in technical standards may be disappointed when reading a statement such as “A keyboard shall be usable for its designated purpose.” However, just this form of expressing the objectives of a standard gives the freedom to design completely new products with features unknown to anyone when a relevant standard was formulated, and still be in compliance with this standard. The price to be paid lies in the effort to understand the objectives of the standard instead of applying what it requires explicitly.

Future regulations in single states of the European Union will adopt the parts of this standard. In addition, future U.S. standards for human–computer interface will at least be compatible with the performance approach of ISO 9241. Since the processing of these standards is synchronized, it is likely that their provisions will be very similar.

With respect to software, various parts of the standard 9241 recommend certain product attributes. The question whether a product shall comply with the recommended form of a particular attribute can only be answered in consideration of the task characteristics and the particular interaction technique employed for the application. Although this approach seems new, in principle, it dates back to Aristotle, the philosopher who coined the term *qualitas* for quality. According to the understanding of quality, a product has no intrinsic quality but only with regard to specified requirements it shall comply with. In the case of software, the requirements have to be formulated considering user and task characteristics. For this reason, it cannot be claimed for a software or user interface to be “ergonomic” without specifying for whom and for what.

References

- Çakir, A. and Dzida, W. 1997 in Helander, M.G., Landauer, T.K., Prabhu, P.V., *Handbook of Human-Computer Interaction*. North-Holland. International Ergonomic HCI Standards.
- Carroll, J.M. and Olson, J.R. 1991. Applying what we know of the user’s knowledge to practical problems, in Helander, M. (Ed.): *Handbook of Human-Computer Interaction*. North-Holland.

- Dillon, A., McKnight, C. and Richardson, J. *Reading From Paper vs. Reading From Screen*. The Computer Journal, 31, 457-464.
- DIN 66234-8 Bildschirmarbeitsplätze — Grundsätze der Dialoggestaltung.
- Dzida, W., Herda, S., Itzfeldt, W.D., and Schubert, H. 1977. Zur Benutzerfreundlichkeit von Dialogsystemen, GMD, St. Augustin.
- EU-Directive 90/270/EEC — Council Directive of 29 May 1990 on the minimum safety and health requirements for work with display screen equipment.
- Galitz, W. O. 1994. It's time to clean your windows — designing GUIs that work, John Wiley & Sons, New York, Chichester, Brisbane, Toronto, Singapore.
- Gould, J.D., Alfaro, L., Barnes, V., Finn, R., Grischkowski, N., and Minuto, A. 1987. Reading is slower from CRT displays than from paper: attempts to isolate a single variable explanation. *Human Factors*, 29 (3), 269-299.
- Harker, S. The development of ergonomics standards for software, *Applied Ergonomics*, 26, 4, 275-279.
- Horton, W. 1991. *Illustrating Computer Documentation*, John Wiley & Sons, Inc., New York.
- IEC 964 Design for control rooms of nuclear power plants, 03.1993.
- IEC 1772 Nuclear power plants — Main control room — Application of visual display units, 08.1995.
- ISO 6385 Ergonomic principles in the design of work systems, draft, 10.1995.
- ISO 9241-2 Ergonomic requirements for office work with visual display terminals (VDTs) — Guidance on task requirements.
- ISO 9241-3 Ergonomic requirements for office work with visual display terminals (VDTs) — Visual display requirements.
- ISO 9241-4 Ergonomic requirements for office work with visual display terminals (VDTs) — Keyboard requirements.
- ISO 9241-5 Ergonomic requirements for office work with visual display terminals (VDTs) — Workstation layout and postural requirements.
- ISO 9241-7 Ergonomic requirements for office work with visual display terminals (VDTs) — Display requirements with reflections.
- ISO 9241-8 Ergonomic requirements for office work with visual display terminals (VDTs) — Requirements for displayed colours.
- ISO/DIS 9241-9 Ergonomic requirements for office work with visual display terminals (VDTs) — Requirements for non-keyboard input devices.
- ISO 9241-10 Ergonomic requirements for office work with visual display terminals (VDTs) — Dialogue principles.
- ISO 9241-11 Ergonomic requirements for office work with visual display terminals (VDTs) — Guidance on usability.
- ISO/FDIS 9241-12 Ergonomic requirements for office work with visual display terminals (VDTs) — Presentation of information.
- ISO/FDIS 9241-13 Ergonomic requirements for office work with visual display terminals (VDTs) — User guidance.
- ISO/FDIS 9241-14 Ergonomic requirements for office work with visual display terminals — Menu dialogues.
- ISO/FDIS 9241-15 Ergonomic requirements for office work with visual display terminals — Command dialogues.
- ISO/DIS 9241-16 Ergonomic requirements for office work with visual display terminals — Direct manipulation dialogues.
- ISO/DIS 9241-17 Ergonomic requirements for office work with visual display terminals — Form-filling dialogues.
- ISO 9995 Information technology — Keyboard layouts for text and office systems. Parts 1 to 8.
- ISO/DIS 13407 Ergonomics of human system interaction — Human centred design processes for interactive systems.

- ISO/IEC 9126 Information technology — Software product evaluation — Quality characteristics and guidelines for their use.
- ISO 13406 Ergonomic requirements for the use of flat panel displays.
- MIL STD 1472 Human engineering design criteria for military systems, equipment and facilities.
- Smith, W. J. 1996. *ISO and ANSI Ergonomic Standards for Computer Products — A Guide to Implementation and Compliance*, Prentice Hall International, Upper Saddle River.
- Smith, S.L. and Mosier, J.N. 1986. Application of guidelines for designing user interface software. *Behaviour and Information Technology*, Vol. 5 No. 1.
- VBG 1995. Unfallverhütungsvorschrift Arbeit an Bildschirmgeräten (VBG 104) (Accident Prevention Rule “Working with Visual Displays), final draft.
- Widdel, H., Post, D. 1992. *Colour in Electronic Displays*. Plenum Press, New York.
- Wright, P. and Lickorish, A. Proof-reading texts on screen and paper. *Behaviour and Information Technology*, 2 (3), 227-235.

23

Psychosocial Factors and Musculoskeletal Disorders in Computer Work

Naomi G. Swanson

*National Institute for Occupational
Safety and Health*

Steven L. Sauter

*National Institute for Occupational
Safety and Health*

23.1	Introduction	23-1
23.2	How Psychosocial Factors May Influence Musculoskeletal Disorders.....	23-2
	Pathway 1: Psychosocial Demands Creating Physiological Strain • Pathway 2: Direct Effects of Psychosocial Factors on Physical Demands • Does the Experience of Musculoskeletal Problems Increase the Reporting of Psychosocial Stressors?	
23.3	Conclusions	23-4

23.1 Introduction

Physical factors and their influence on health among computer or video display terminal (VDT) workers have been studied since the 1970s, and a range of workstation and physical environmental factors have been linked with musculoskeletal problems in VDT work (Cakir et al., 1978; Hunting et al., 1981; Maeda et al., 1980; Ong et al., 1981; Onishi et al., 1973; Sauter et al., 1991a). There have been significant improvements in the ergonomic aspects of office environments since personal computers were first introduced. However, musculoskeletal problems among computer users are still commonplace. In recent years, increasing attention has been given to psychosocial stressors for their possible etiological role in musculoskeletal disorders among computer users. However, this work is still formative, lacking a widely accepted model of how psychosocial stressors act to influence musculoskeletal outcomes. For that matter, even the concept of psychosocial factors seems elusive to many ergonomists and occupational health professionals. The present chapter provides a definition of workplace psychosocial factors, suggests pathways by which psychosocial factors can influence musculoskeletal disorders, and provides research evidence for these pathways.

What are psychosocial factors? We define psychosocial factors as attributes of the job and the individual that influence psychological demands and thus contribute to job stress (Sauter and Swanson, 1996). These factors include aspects of job content, such as workload, skill usage, clarity of demands, control over tasks; organizational aspects of the job, such as participation in decision making and career issues; interpersonal relationships, such as co-worker and supervisor support, and availability of feedback; and temporal aspects of the job, such as pacing and hours of work. Also included are individual factors, such as age, marital status, prior learning and experience, coping strategies, and personality factors, although we treat these factors as

intervening variables that can moderate or modify the demands imposed by the job characteristics or stressors mentioned above. In other words, the primary emphasis is on the influence of job or work environment stressors, not individual factors, as risk factors for job stress and associated health disorders.

Changes in the office psychosocial work environment related to computerization. The introduction of computers into the office environment has greatly changed the way in which work is accomplished. While office automation holds the promise of task and skill enlargement, and more worker control over tasks, there are indications that this promise is not met with some types of VDT work. Early studies by NIOSH of clerical workers who used computers and their counterparts who did not found that the computer users reported significantly greater work pressure and supervisory control and less autonomy, role clarity, and support from co-workers (Smith et al., 1981; Sauter et al., 1983a, 1983b). More recent confirming evidence was reported by Bammer (1987) and Asakura and Fujigaki (1993) who found that the introduction of computers into office work was related to increased time/job pressures, lessened job discretion, and a reduction in task diversity. Korunka et al. (1995) reported differential effects of the introduction of new computer technologies on jobs, depending on the initial characteristics of the jobs. For those jobs which were monotonous and relatively menial (e.g., cashier work, telephone information work), introduction of computerized technologies led to a deterioration of working conditions, while for jobs that were more challenging (e.g., computer-aided drawing), the introduction of new technology led to an improvement in working conditions (e.g., greater participation, control, skill usage, etc.).

23.2 How Psychosocial Factors May Influence Musculoskeletal Disorders

Although the relationship between psychosocial stressors and musculoskeletal problems in computer users has gained increasing attention in recent years, there is uncertainty regarding the pathways which relate the two. Sauter and Swanson (1996) and others (Bongers et al., 1993; Sauter, 1991b; Sauter et al., 1983a; Smith and Carayon, 1996) have proposed two major pathways by which psychosocial factors may influence musculoskeletal disorders. In the first pathway, psychosocial factors themselves create physiological strain via a generalized stress response. This stress-related physiological strain can then exacerbate task-related biomechanical strains. For example, stress resulting from work-related psychosocial demands may produce increments in muscle tension that add to the muscle loads and symptoms related to physical task demands. In the second pathway, psychosocial factors may influence physical work demands directly. For example, increased fractionation of tasks can result in increased repetitiveness.

Although the evidence to date cannot fully verify these pathways (i.e., due primarily to the cross-sectional design of most of these studies, which limits causal determination), there is still a wide range of studies that provide support for these pathways. This research is summarized below.

Pathway 1: Psychosocial Demands Creating Physiological Strain

Studies relating physical and emotional stressors to physiological strain date from the early part of this century (Cannon, 1929, 1935; Selye, 1936, 1946). These early studies have demonstrated that exposure to stress results in increases in blood pressure, corticosteroids, peripheral neurotransmitters, and muscle tension. All of these physiological changes ready the organism to respond to threatening situations. More recent work by Johansson and Aronsson (1984), Frankenhaeuser and Johansson (1986), and Lundberg et al. (1989, 1993) have indicated that work-related psychosocial stressors such as low decision latitude, and boring and repetitive tasks can result in similar physiological strain as evidenced by outcomes such as increases in blood pressure, heart rate, and corticosteroid levels. Smith and Carayon (1996) hypothesize that these physiological reactions to psychosocial stressors can increase the susceptibility of nerves and muscles to damage. For example, increases in fluid retention in peripheral body tissues due to increased levels of corticosteroids might exacerbate nerve compression in structures such as the carpal tunnel.

Smith and Carayon suggest that if the exposure to the psychosocial stressor(s) is chronic or prolonged, permanent tissue damage may result. To date, however, this hypothesis has not been tested empirically.

Increased muscle tension has been the physiological response that has received the most attention as a possible mechanism connecting stress to musculoskeletal disorders. Certain psychological states, such as anxiety, have long been associated with muscle over-activity (Jacobsen, 1931; Sainsbury and Gibson, 1954). Recent studies of office workers have demonstrated that stressful task demands result in increased muscle tension that is unrelated to the physical demands of the job. For example, Westgaard and his colleagues (Waersted et al., 1987, 1991; Westgaard and Bjorkland, 1987) have reported sustained attention-related muscle loads of 0.5 to 3% maximum voluntary contraction (MVC) during the performance of VDT-based psychophysical tasks. These results are consistent with an earlier study by Weber et al. (1980) who reported increases in neck muscle activity and perceived tension among subjects completing cognitively complex tasks. Ekberg et al. (1995) and Lundberg and Melin (1995) have also reported higher static muscle loads among subjects exposed to psychologically stressful tasks.

Both Waersted et al. (1991) and Lundberg and Melin (1995) hypothesize that jobs which are psychologically stressful or demanding, even though they may not be demanding physically, may carry a risk for musculoskeletal disorders due to the sustained elevations in muscle tension induced by the psychological demands. Several investigators have found a relationship between sustained low-level static muscle activity and discomfort or sick leave in the workplace (Aaras, 1994; Veierstad, 1994), although not all investigations have been able to replicate this finding (e.g., Westgaard and Vasseljen, 1995).

Pathway 2: Direct Effects of Psychosocial Factors on Physical Demands

Studies that have examined the relationship between musculoskeletal disorders and both physical and psychosocial factors in the office environment have generally found that both sets of factors are related to musculoskeletal problems (Bernard et al., 1992; Bergqvist et al., 1995; Faucett and Rempel, 1994; Hoekstra et al., 1995; Kamwendo et al., 1991; Pot et al., 1987; Ryan and Bampton, 1988). A number of these studies report interactive effects between the psychosocial and physical factors. In other words, the psychosocial stressors appear to change the physical demands of the job. Several studies offer support for this premise.

Smith et al. (1981) queried office workers about psychosocial stressors, ergonomic factors, and health outcomes. Three groups of workers were examined — clericals who did not use VDTs, and clericals and professionals who did use VDTs. The clericals who used VDTs reported the highest level of psychosocial stressors and the most musculoskeletal symptoms, while the professionals reported the lowest level of psychosocial stressors and the least musculoskeletal symptoms. An examination of the jobs revealed important differences in job content that may have accounted for these differences. The clericals were subjected to rigid work procedures, high production standards, high pressure to complete their work, and had little control over their work. The professionals, on the other hand, had a great deal of flexibility and control over their jobs, and made use of their training and skills in their jobs. It was conjectured that these differences in job content influenced the physical demands of the job, translating into differences in workload, work pace, repetitiveness, and time on the VDT, and thus probably influenced the experience of musculoskeletal symptoms among the workers.

A study by Lim and Carayon (1993; 1995) provides additional evidence that psychosocial stressors may change or exacerbate ergonomic stressors among office workers. In a field study of office/VDT workers, they found that psychosocial factors influenced musculoskeletal symptoms via effects on ergonomic factors. In other words, psychosocial factors, such as work pressure, production standards, and task control, directly influenced ergonomic aspects of the job such as repetitiveness and work postures. The study found, for example, that individuals with more control over their work performed less repetitive work, and those who worked under production standards sat in more fixed, static work postures. Awkward work postures and repetitiveness, in turn, predicted musculoskeletal symptoms.

Does the Experience of Musculoskeletal Problems Increase the Reporting of Psychosocial Stressors?

One issue that researchers have struggled with is the direction of the relationship between musculoskeletal disorders and psychosocial factors. The studies reported above are all cross-sectional in design and do not answer whether the experience of symptoms results in a perception of a less favorable psychosocial work environment, or if the poorer psychosocial work environment precedes the development of musculoskeletal symptoms. While the answer to this question can ultimately only be answered definitively with long-term studies simultaneously examining the development of musculoskeletal symptoms and perceptions of the psychosocial work environment, evidence from two studies suggests that the latter relationship holds. These studies examined only asymptomatic worker's assessments of the psychosocial environment in office settings with high or low rates of musculoskeletal problems. (Thus, study results could not be influenced by the experience of musculoskeletal problems in the workplace.) Both Hopkins (1990) and Stephens and Smith (1996) found that worksites with high rates of musculoskeletal symptoms had lower levels of co-worker support, less control and autonomy, less clarity about their jobs, more work pressure and stress, and less job satisfaction.

23.3 Conclusions

Although not conclusive, current evidence suggests that workplace psychosocial stressors influence musculoskeletal disorders in computer workers via the two pathways discussed in the present chapter. Other pathways, such as the influence of the psychosocial work environment on the perception and reporting of symptoms have been proposed (see Sauter and Swanson, 1996), although the evidence in support of these pathways is more limited. It is clear that more work is needed to better elucidate mechanisms linking psychosocial factors and musculoskeletal symptoms. Longitudinal studies are also needed, as well as better exposure assessment methods. However, the evidence to date points to the need for a holistic assessment of the computerized workplace in order to determine which aspects of the workplace need to be modified. While the importance of physical or ergonomic factors is not in question, there are indications that changes in the physical work environment without attention to the psychosocial work environment may not be sufficient to prevent or reduce musculoskeletal disorders in the computerized workplace (Spillane and Deves, 1988).

References

- Aaras, A. 1994. Relationship between trapezius load and the incidence of musculoskeletal illness in the neck and shoulder. *International Journal of Industrial Ergonomics*, 14, 341-348.
- Asakura, T. and Fujigaki, Y. 1993. The impact of computer technology on job characteristics and workers' health, in *Human-Computer Interaction: Applications and Case Studies*, Eds. M.J. Smith and G. Salvendy, p. 982-987. Elsevier, New York.
- Bammer, G. 1987. VDUs and musculo-skeletal problems at the Australian National University — a case study, in *Work with Display Units 86*, Eds. B. Knave and P.-G. Wideback, p. 279-287. Elsevier Science Publishers B.V. (North Holland), Amsterdam.
- Bergqvist, U., Wolgast, E., Nilsson, B. and Voss, M. 1995. Musculoskeletal disorders among visual display terminal workers: individual, ergonomic, and work organizational factors. *Ergonomics*, 38(4), 763-776.
- Bernard, B., Sauter, S.L., Fine, L.J., Petersen, M.R. and Hales, T.R. 1992. Psychosocial and work organization risk factors for cumulative trauma disorders in the hands and wrists of newspaper employees. *Scandinavian Journal of Work, Environment and Health*, 18 (Suppl. 2), 119-120.
- Bongers, P.M., De Winter, C.R., Kompier, M.J. and Hildebrandt, V.H. 1993. Psychosocial factors and work and musculoskeletal disease. *Scandinavian Journal of Work, Environment and Health*, 19(5), 297-312.

- Cakir, A., Hart, D.J. and Stewart, D.F.M. 1978. *Research into the Effects of Video Display Workplaces on the Physical and Psychological Function of Persons*. Federal Ministry for Work and Social Order, Bonn, West Germany.
- Cannon, W.B. 1929. *Bodily Changes in Pain, Hunger, Fear and Rage*. C.T. Branford, Boston.
- Cannon, W.B. 1935. Stresses and strains of homeostasis. *American Journal of Medical Science*, 189, 1-14.
- Ekberg, K., Eklund, J., Tuveesson, M., Ortengren, R., Odenrick, P. and Ericson, M. 1995. Psychological stress and muscle activity during data entry at visual display units. *Work and Stress*, 9(4), 475-490.
- Faucett, J. and Rempel, D. 1994. VDT-related musculoskeletal symptoms: Interactions between work posture and psychosocial work factors. *American Journal of Industrial Medicine*, 26, 597-612.
- Frankenhaeuser, M. and Johansson, G. 1986. Stress at work: psychobiological and psychosocial aspects. *International Review of Applied Psychology*, 35, 287-299.
- Hoekstra, E., Hurrell, J. and Swanson, N. 1995. Evaluation of work-related musculoskeletal disorders and job stress among teleservice center representatives. *Applied Occupational and Environmental Hygiene*, 10(10), 812-817.
- Hopkins, A. 1990. Stress, the quality of work, and repetition strain injury in Australia. *Work and Stress*, 4(2), 129-138.
- Hunting, W., Laubli, T. and Grandjean, E. 1981. Postural and visual loads at VDT workplaces: I. Constrained postures. *Ergonomics*, 24, 917-931.
- Jacobsen, E. 1931. Electrical measurements of neuromuscular states during mental activities. *American Journal of Physiology*, 97, 200-209.
- Johansson, G. and Aronsson, G. 1984. Stress reactions in computerized administrative work. *Journal of Occupational Behavior*, 5, 159-181.
- Kamwendo, K., Linton, S.J. and Moritz, U. 1991. Neck and shoulder disorders in medical secretaries. Part I. Pain prevalence and risk factors. *Scandinavian Journal of Rehabilitative Medicine*, 23, 127-133.
- Korunka, C., Weiss, A., Huemer, K.H. and Karetta, B. 1995. The effect of new technologies on job satisfaction and psychosomatic complaints. *Applied Psychology: An International Review*, 44(2), 123-142.
- Lim, S.Y. and Carayon, P. 1993. An integrated approach to cumulative trauma disorders in computerized offices: The role of psychosocial work factors, psychological stress and ergonomic risk factors, in *Human-Computer Interaction: Applications and Case Studies*, Eds. M.J. Smith and G. Salvendy, p. 880-885. Elsevier, New York.
- Lim, S.Y. and Carayon, P. 1995. Psychosocial work factors and upper extremity musculoskeletal discomfort among office workers, in *Work with Display Units 94*, Eds. A. Grieco, G. Molteni, B. Piccoli and E. Occhipinti, p. 57-62. Elsevier Science B.V., Amsterdam.
- Lundberg, U. and Melin, B. 1995. Stress, muscular tension and musculoskeletal disorders, in *Premus 95: Second International Conference on Prevention of Work-Related Musculoskeletal Disorders*, Montreal, Quebec, September 24-28, p. 167-168.
- Lundberg, U., Granqvist, M., Hansson, T., Magnusson, M. and Wallin, L. 1989. Psychological and physiological stress responses during repetitive work at an assembly line. *Work and Stress*, 3, 143-153.
- Lundberg, U., Melin, B., Evans, G.W. and Holmberg, L. 1993. Physiological deactivation after two contrasting tasks at a video display terminal: learning vs. repetitive data entry. *Ergonomics*, 36(6) 601-611.
- Maeda, K., Hunting, W. and Grandjean, E. 1980. Localized fatigue in accounting-machine operators. *Journal of Occupational Medicine*, 22, 810-816.
- Ong, C.N., Hoong, B.T. and Phoon, W.O. 1981. Visual and muscular fatigue in operators using visual display terminals. *Journal of Human Ergology*, 10, 161-171.
- Onishi, N., Normura, H. and Sakai, K. 1973. Fatigue and strength of upper limb muscles of flight reservation system operators. *Journal of Human Ergology*, 2, 133-141.
- Pot, F., Padmos, P. and Brouwers, A. 1987. Determinants of the VDU operator's well-being, in *Work with Display Units 86*, Eds. B. Knave and P.G. Wideback, p. 16-25. North-Holland, Amsterdam.
- Ryan, G.A. and Bampton, M. 1988. Comparison of data process operators with and without upper limb symptoms. *Community Health Studies*, 12(1), 63-68.

- Sainsbury, P. and Gibson, J.G. 1954. Symptoms of anxiety and tension and the accompanying physiological changes in the muscular system. *Journal of Neurology, Neurosurgery and Psychiatry*, 17, 216-224.
- Sauter, S.L., Schleifer, L.M. and Knutson, S.J. 1991a. Work posture, workstation design, and musculoskeletal discomfort in a VDT data entry task. *Human Factors*, 33(2), 151-167.
- Sauter, S.L. 1991b. Ergonomics, stress and the redesign of office work. Presentation at *The National Occupational Musculoskeletal Injury Conference*, Ann Arbor, MI.
- Sauter, S.L. and Swanson, N.G. 1996. An ecological model of musculoskeletal disorders in office work, in *Beyond Biomechanics: Psychosocial Aspects of Musculoskeletal Disorders in Office Work*, Eds. S. Moon and S.L. Sauter, p. 3-21. Taylor & Francis, London.
- Sauter, S.L., Gottlieb, M.S., Jones, K.C., Dodson, V.N. and Rohrer, K. 1983a. Job and health implications of VDT use: Initial results of the Wisconsin-NIOSH study. *Communications of the Association for Computing Machinery*, 26(4), 284-294.
- Sauter, Gottlieb, M.S., Rohrer, K.M. and Dodson, V.N. 1983b. *The Well-Being of Video Display Terminal Users: An Exploratory Study*, University of Wisconsin Department of Preventive Medicine, Madison, WI.
- Selye, H. 1936. A syndrome produced by diverse noxious agents. *Nature*, 138, 32.
- Selye, H. 1946. The general adaptation syndrome and diseases of adaptation. *Journal of Clinical Endocrinology*, 6, 217-230.
- Smith, M.J. and Carayon, P. 1996. Work organization, stress and cumulative trauma disorders, in *Beyond Biomechanics: Psychosocial Aspects of Musculoskeletal Disorders in Office Work*, Eds., S.D. Moon and S.L. Sauter, p. 23-42. Taylor & Francis, London.
- Smith, M.J., Cohen, B.G.F., Stammerjohn, L.W. and Happ, A. 1981. An investigation of health complaints and job stress in video display operations. *Human Factors*, 23(4), 387-400.
- Spillane, R.M. and Deves, L.A. 1988. Psychosocial correlates of RSI reporting. *Journal of Occupational Safety*, 4(1), 21-27.
- Stephens, C. and Smith, M. 1996. Occupational overuse syndrome and the effects of psychosocial stressors on keyboard users in the newspaper industry. *Work and Stress*, 10(2), 141-153.
- Veierstad, K.B. 1994. Sustained muscle tension as a risk factor for trapezius myalgia. *International Journal of Industrial Ergonomics*, 14, 333-339.
- Waersted, M., Bjorklund, R.A. and Westgaard, R.H. 1987. Generation of muscle tension related to a demand of continuing attention, in *Work with Display Units 86*, Eds. B. Knave and P.-G. Wideback, p. 288-293. North-Holland, Amsterdam.
- Waersted, M., Bjorkland, R.A. and Westgaard, R.H. 1991. Shoulder muscle tension induced by two VDU-based tasks of different complexity. *Ergonomics*, 34(2), 137-150.
- Weber, A., Fussler, C., O'Hanlon, J.F., Gierer, R. and Grandjean, E. 1980. Psychophysiological effects of repetitive tasks. *Ergonomics*, 23(11), 1033-1046.
- Westgaard, R.H. and Bjorkland, R. 1987. Generation of muscle tension additional to postural muscle load. *Ergonomics*, 30(6), 911-923.
- Westgaard, R.H. and Vasseljen, O. 1995. The relationship between perceived tension, observed muscle tension in the trapezius muscle and psychosocial factors, in *Premus 95: Second International Conference on Prevention of Work-Related Musculoskeletal Disorders*, Montreal, Quebec, September 24-28, p. 181-183.

For Further Information

An excellent multidisciplinary overview of the influence of psychosocial factors on musculoskeletal disorders in office work is provided by *Beyond Biomechanics: Psychosocial Aspects of Musculoskeletal Disorders in Office Work*, Eds. S.D. Moon and S.L. Sauter. Taylor & Francis Ltd., New York, 1996.

The proceedings of several human factors/ergonomics conferences routinely report the results of studies examining the effects of psychosocial factors on musculoskeletal disorders in office environments.

These include *The Human Factors and Ergonomics Society* and *The International Ergonomics Association*, which meet annually, and *Work with Display Units* and *Human-Computer Interaction*, which meet biannually or triennially.

Scientific studies on workplace psychosocial factors are published in a wide array of human factors/ergonomics, stress, and public health journals, including *Human Factors*, *Ergonomics*, *International Journal of Human-Computer Interaction*, *Journal of Occupational and Environmental Medicine*, *Scandinavian Journal of Work, Environment and Health*, and *Work and Stress*.

24

User-Centered Software Development: Methodology and Usability Issues

Udo Konradt
Ruhr-University of Bochum

Bernhard Zimolong
Ruhr-University of Bochum

Barbara Majonica
Ruhr-University of Bochum

24.1	Introduction	24-1
24.2	Software Design Is Work Design	24-2
24.3	Some Stages of the Software Life Cycle: A Case Study	24-2
	Understanding Business and Market Requirements: Supporting Tasks by Software • Understanding the Work: Job Analysis • Understanding Individual Methods of Working: Task Analysis • Bridging the Gap between Requirements and Design • Understanding the Usefulness of the Application: Usability Study	
24.4	Conclusions	24-10

24.1 Introduction

Many authors have argued that the small to medium-sized batch manufacturing sector will be characterized by increased competition, smaller batch sizes, and increased demand for customization and product variety (Brödner, 1990; Clegg and Symon, 1989). Market requirements will be accompanied by more nonroutine variances, higher capital cost of production systems, and relatively lower labor costs. As a response to this challenge, the production island concept is increasingly gaining in significance as an efficient production concept. Production islands, with their quasihomogeneous qualification structure, can — from a manufacturing perspective — react more flexibly to the varying requirements of the market than centralized and hierarchical organizations. Most organizations adopt a traditional technology-centered approach to the design and implementation of new manufacturing systems. The technical aspects command most resources and are considered first in the planning and design stage. Human and organizational factors are only considered relatively late in the process, and sometimes only after the system is operational (Corbett, Rasmussen, and Rauner, 1991). Countervailing approaches, e.g., the sociotechnical and human-centered systems design, share the idea that people and organizational structures must be designed parallel to the technical structures. Concepts such as “Kaizen” (Imai, 1994), “Business Reengineering” (Hammer and Champy, 1993), or “Agile Manufacturing” (Kidd, 1994) emphasize the role of organizational and human factors in the production process.

At the University of Bochum, an interdisciplinary research group, including engineers, social scientists, and economists, developed and evaluated flexible manufacturing structures on the basis of semiautonomous

production islands (Zimolong, 1996). This approach reflects, unlike the centralized system architecture, commonly associated with the technology approach, organizational structures and processes that are integrated in terms of production islands. It emphasizes the reintegration of design, planning, and manufacturing. In particular, tasks of quality assurance, maintenance, and repair are integrated into shop floor activities. Although the computer controls routine operations, the planning and decision making is left to the personnel. Consequently, human-machine interface has to be designed to allow the worker to understand the workings of the machine and to develop his or her experience and skill in the machining process.

The increasing complexity of machine tools requires an information database and decision support system (DSS) to aid workers in quality assurance, diagnosis, and repair. This paper describes the incremental development of a decision support system for maintenance tasks in semiautonomous production islands that fosters the acquisition of abilities and the human learning process and that is adaptive to the individually preferred methods of working. At first, we explicate the design philosophy, thereafter the main design steps, and finally the usability results gained so far.

24.2 Software Design Is Work Design

The use of information technology and the design of software should be part of an in-plant process of innovation and organizational growth that follows strategic decisions made by the management. Strategic decisions suggest the portfolio of important future markets the firm wants to secure or develop. At the tactical level, decisions are concerned with structural aspects of work organization, technical ways to support them, and personal development. The use of personnel, technology, and organization must be subordinate to the strategies of the business. The succeeding tactical plans and operative conversions must be judged with reference to these plans and policies.

In Figure 24.1 a scheme is presented reflecting major concepts and their relationships in system development. The “Process-Oriented Task Analysis” (PTA, Konradt, 1996) stresses practical application dealing with characteristics of users, tasks, and organizational forms as the fundamental aspects of system development. In PTA, management decisions that define business processes are embedded in a top-down perspective. Task structures of users are embedded through action strategies in a bottom-up perspective. The design of user-centered software requires taking into account the user’s professional competence in addition to the degree of experience and types of cognitive preferences. Starting from the goals of the organization, objects of the working and recreational world of the user are brought forth and implemented in an evolutionary and participatory system design process.

24.3 Some Stages of the Software Life Cycle: A Case Study

The development of software systems is composed of different phases that create the software life cycle. Although the models differ in types of classification, procedures, and details, they usually contain requirements analysis, design, implementation, and evaluation.

To our view, requirements analysis is a central part in the software development process, because it determines the decomposition of problems, the hierarchical structure of the system, the specification of main features, and the design of user interfaces. Usability problems often originate from flaws in the requirements analysis, which may be properly conducted with respect to the functional needs, but not with respect to the organizational and psychological requirements of the user (see Table 24.1). Object-oriented analysis and design (OOAD) is a methodology to support the translation of user demands more smoothly in prototypes (Monarchi and Puhr, 1992) and an attempt to bridge the gap between analysis and design. In OOAD, data structures are defined in user language, and actions are subsequently matched. Domains of users are represented through specification of a set of semantic objects that are revealed in cognitive task analysis. In this case, objects were derived from strategies of operators. Figure 24.2 presents major steps in the project model.

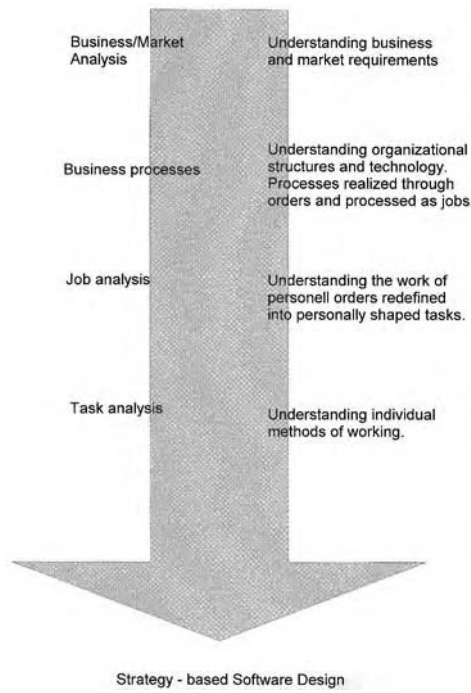

FIGURE 24.1 Simplified model of the process-oriented task analysis

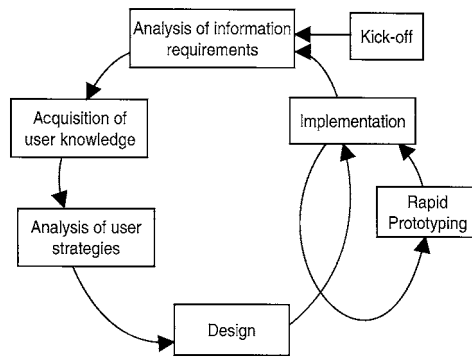

FIGURE 24.2 Major steps in strategy-based software development

TABLE 24.1 Organizational, Functional, and Psychological Aspects of Task Analysis

Job and Task Analysis Maintenance, Diagnosis, Repair

Organizational analysis	Type of work organization; collaboration central maintenance/machine operators; information requirements, allocation of responsibilities.
Functional analysis	Preventive maintenance tasks; failure analysis; deviations, failures, breakdowns; fixing, replacement of parts.
Psychological analysis	Cognitive and mental strategies, rules and procedures; information needs; user qualification; user acceptance.

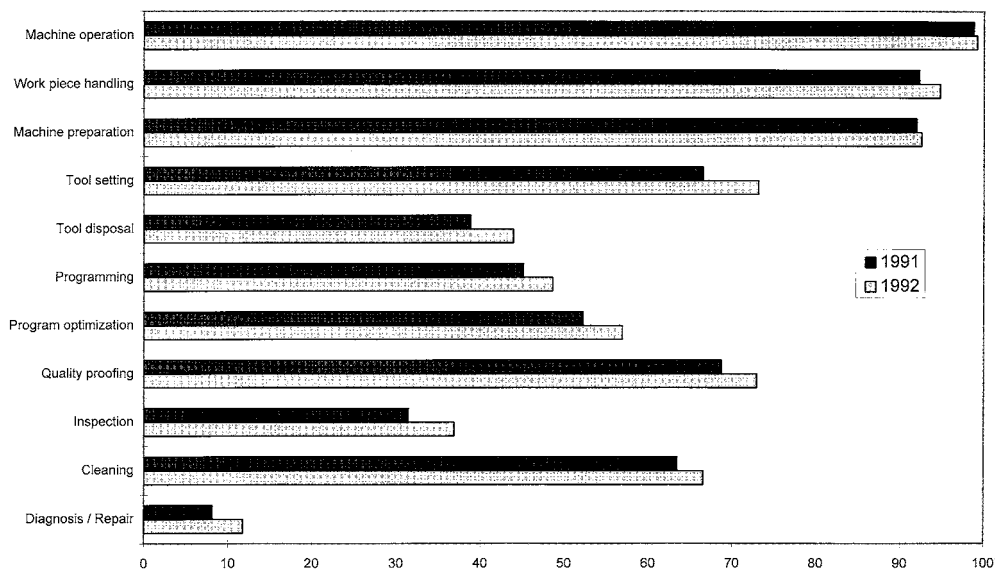

FIGURE 24.3 Functional task analysis of operators at numerically controlled machines in 1991 and 1992. Results of a representative survey in Germany in the machining industry.

Understanding Business and Market Requirements: Supporting Tasks by Software

Following the concept of semiautonomous work groups, a variety of tasks which are commonly allocated to different departments are reintegrated into manufacturing units, such as planning, scheduling, preventive maintenance, troubleshooting, and even repair. Figure 24.3 shows the results of a representative survey of the Sonderforschungsberüch (SFB) 187, which encompasses about 2,200 firms of the metal-manufacturing industry in Germany (Ostendorf and Seitz, 1992; Zimolong and Saurwein, 1995). In 1991, 8.2% of the companies reported that operators at the shop floor were completely or to a greater part engaged in maintenance and servicing tasks. In 1992 there was even an increase of 3.7 to 11.9%. The results stress the increasing significance of the integration of maintenance and repair tasks into the work of operators. In small and medium-sized companies, maintenance and repair tasks are usually performed by operators and not by specialists. It remains unaddressed whether operators usually are qualified to handle preventive maintenance, troubleshooting, and in some cases even repair (see the in-depth work analysis in the following chapter).

Maintenance tasks usually pose high information and decision demands on the technicians. The number of alternatives and the interconnectivity of components, symptoms, and possible operations show that maintenance tasks usually are complex problem-solving tasks. Moreover, business processes in maintenance are closely interconnected with other different processes usually carried out by different departments, like quality assurance and operation scheduling. Assuring operativeness, as a process in maintenance, for example, has the preconditions of keeping the flow time in operations scheduling and keeping the date of completion in quality assurance, but is often impeded by functions and divisions. The organizational concept of semiautonomous work groups, responsible for production planning, time-scheduling of material, manufacturing, quality control, maintenance, and repair has the potential to overcome some of these problems. On the other hand, in work groups the need for information and decision support on the shop floor increases, leading to the usage of decentralized information systems at the shop floor. In that sense, information systems incorporating decision support facilities are not only potentive tools but also a precondition for the decentralization of maintenance tasks. Support systems specifically promote a lot of aspects of semiautonomous working groups, including:

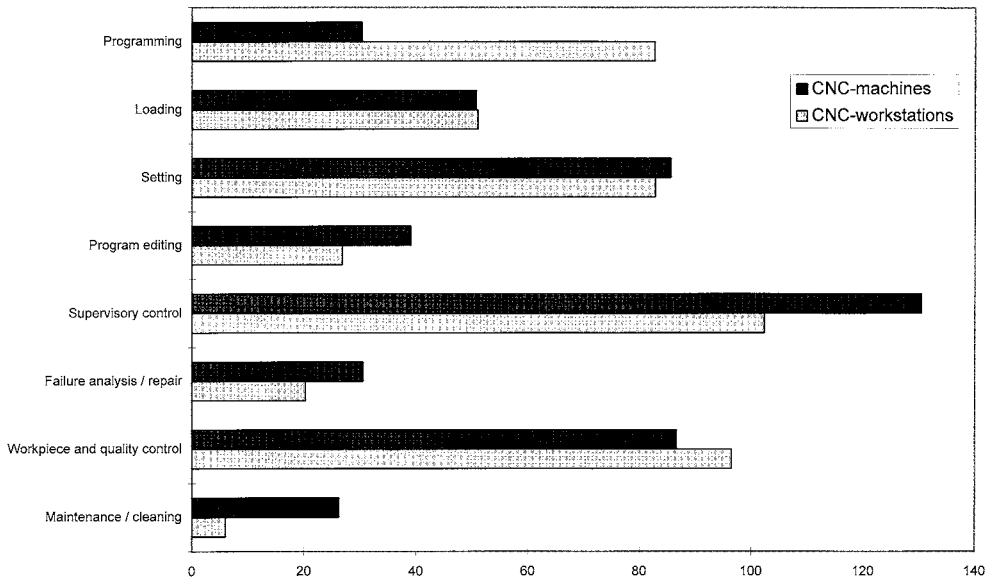

FIGURE 24.4 Task and time study of operators in computer-controlled work systems (in minutes).

- The allowance to integrate workers with very different qualifications, e.g., apprenticeships and highly qualified maintenance technicians
- The reduction in diagnosis and repair time
- The increase of qualification of the working group members through the accesses of the jointly acquired knowledge base

Understanding the Work: Job Analysis

The analysis of market and business requirements leads to the conclusion that decentralized maintenance tasks accomplished by machine operators in work groups may well be supported by an information and decision support system. Looking at the job in more detail should reveal what kind of typical tasks are fulfilled by operators, what amount of time they need, and what kind of qualifications they have.

Consequently, a job analysis was carried out to analyze typical functions of operators and qualification requirements in small and medium-sized metal-manufacturing companies. Seven small and medium-sized companies of the metal-manufacturing industry were examined. A sample of 21 computer-controlled work systems out of 105 systems was chosen for the work analysis. The analysis included eleven CNC-machines and eight CNC-workstations. The results of the 19 work systems are representative for the 86 computer-controlled work systems. A more detailed description of the sample studied can be found in Konradt and Zimolong (1993).

Main tasks and average working time for each task are indicated in Figure 24.4. Eight main tasks of operators were classified. As the results show, operators mainly perform supervisory tasks (CNC-machines: 24.9%, CNC-workstation: 17.5%), followed by workpiece and quality control tasks (15.7%; 19.4%). Results correspond closely to those reported in Fix-Sterz, Lay and Schultz-Wild (1986).

A detailed functional analysis of the task “failure analysis and repair” was carried out. These tasks consume 30.6 min (7.6%) of the job time at CNC-machines and 20.3 min (4.4%) at CNC-workstations. Diagnosis and repair activities fill out nearly half of the time (57.5%; 43.3%). Note the considerable amount of time (30%) operators spent to support diagnosis activities of maintenance personnel. Work time of operators required for failure diagnosis and repair differs considerably between both work systems.

Operators are less involved in troubleshooting activities at CNC-workstations due to their complex technology.

In general, the availability and utilization of computer-controlled work systems in industry differ significantly. For flexible manufacturing systems (FMS) a technical availability between 70 and 98% is reported. A survey among 17 users of FMSs in five West European countries was reported by Shah (1987), indicating a range of actual utilization between 67 and 95%. An overview on availability, actual utilization and stoppage causes is provided in Zimolong and Duda (1992). In computer-controlled work systems, operators spent a considerable amount of time on troubleshooting activities. The particular activities which were identified by our in-depth study are diagnoses of failures, working on repair, and support for external repair personnel.

Understanding Individual Methods of Working: Task Analysis

A comprehensive task analysis is based on organizational, functional, and psychological requirements (refer to Table 24.1 for details). The functional analysis is concerned with the questions: What needs to be done? The psychological analysis asks: How can people do it? How did they accomplish similar tasks in the past? How will they do it in the future? The organizational analysis asks questions such as: What kinds of responsibilities should be allocated to the job incumbents? What kind of information is required? Who else should be involved in the accomplishment of the task? In the following section, we concentrate on the psychological requirements analysis.

With respect to their qualification levels, kind of experience and situational constraints, maintenance personnel develop specific strategies to locate failures of stoppages or breakdowns. They hesitate to engage immediately in systematic reasoning and failure testing. Instead, they use a variety of quick opening strategies before entering into more systematic checks and tests. In an empirical study, the application of strategies in failure diagnosis in computer-controlled manufacturing systems was analyzed with dependence on the user and task variables (Konradt, 1995).

The analysis included 22 electricians and mechanics from the central maintenance and repair departments of five companies in the metal-manufacturing industry. Age varied between 20 and 57 years, on average 33.7 years. Professional experience varied between one and 40 years, on average 15.5 years. Beginners had up to 5 years of experience, advanced 6 to 20 years, and experts more than 20 years of work experience. Their rules of troubleshooting were recorded by means of verbal interviews using a scenario technique. Interviews were conducted for three types of failure cases at CNC-machines: rare, less frequent, and frequently emerging failures and breakdowns. In total, 69 interviews were conducted and 182 rules were identified and classified into 15 diagnosis strategies.

Results show that the most frequent troubleshooting strategies were "Historical information," "Least effort," "Reconstruction," and "Sensory check" (Figure 24.5). Historical information about types and frequencies of breakdowns of the machine tools is used through maintenance records, failure statistics, and contact with colleagues. Least effort means that simple checks are used first. Reconstruction requires that the operator or a colleague is asked about the failure course. By sensory check, symptoms such as loose connections, odors, or sounds are located. It is not affordable to use measuring instruments. In contrast, strategies such as "Information uncertainty" and "Split half," which lead to a binary reduction of the problem space only play a minor role in troubleshooting machine tools.

In diagnostic search two basically different maintenance and repair strategies were proposed (Rasmussen, 1981). "Symptomatic search" comprises a set of symptoms collected by the operator, and this set is matched to a set of symptoms under normal system state. If the search is performed in the actual system or physical domain, it is called "topographic search." Our results suggest a further class of generalized strategies called "case-based." In case-based strategies, symptoms available in the diagnostic situation are collected and compared to those in similar cases. In novel failure cases, topographic search dominates. In routine failures case-based strategies are most frequently used and the importance of topographical strategies is diminished. Finally, topographical and case-based strategies are dominant in familiar failure cases.

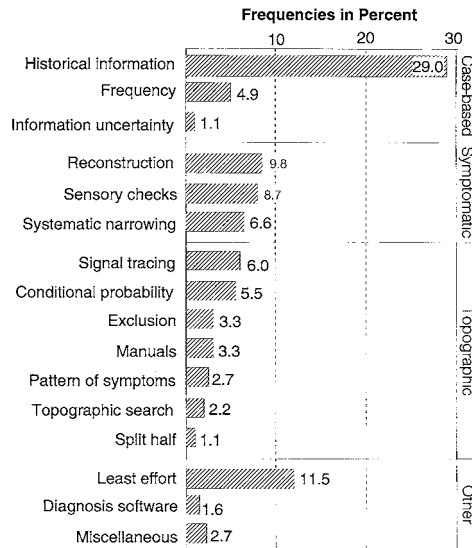

FIGURE 24.5 Frequencies of failure diagnosis strategies and their relation to generalized strategy classes.

Results of task analysis of maintenance personnel mirror a distinctive and complex picture of troubleshooting procedures. Maintenance experts do not engage immediately in systematic reasoning and failure testing due to time constraints and the heavy burden they put on short term memory and decision making. In contrast, they use a variety of quick-opening strategies before entering into more systematic checks and tests. These strategies require specific kinds of information. For example, the strategy “historical information” demands a list of failures and technical changes made in the life cycle of the machine. The particular information and documentation demands of novices and experts, including explanations and support in planning, can be inferred from strategies, too.

Bridging the Gap between Requirements and Design

The three main troubleshooting strategies — symptomatic, topographic, and case-based search — led to the result that it is essential to support all strategies and their various rules and procedures. All of them were translated into semantic objects, which were then transformed into the objects of the software design. Objects were grouped into four modules: the *system module* gives an overview of the system and its components; the *information module* contains the basic structures of the machine tool, circuit diagrams, technical data, and descriptions of single elements; the *diagnosis module* comprises all data on symptoms and failures; the *logbook* stores the breakdowns, failure types, their related symptoms and statistics.

In detail, data structures were derived through specification of a set of semantic objects that are necessary to carry out a strategy revealed in cognitive task analysis. The methodology is called “Strategy-Based Software Design” (SSD, Konradt, 1995). It is assumed that software should be compatible to the operator and an appropriate tool in working tasks. Moreover, a continuous transition between analysis results and design should be guaranteed.

In Figure 24.6, the three stages of SSD are represented. The support of the strategy “Sensory checks,” for example, requires the implementation of objects generally used by the operator pursuing this strategy. Typical objects are components of the machine, symptoms, lists of identified components and symptoms, failures, and causes of failures. Operations such as selection, search, input, and relation are defined according to the objects. This procedure is put forth with every one of the other 14 strategies. It is evident that several strategies require the same objects. It is therefore logical to take advantage of common elements from different strategies rather than handling each strategy separately. The elements of the strategies provide the bonds in a network

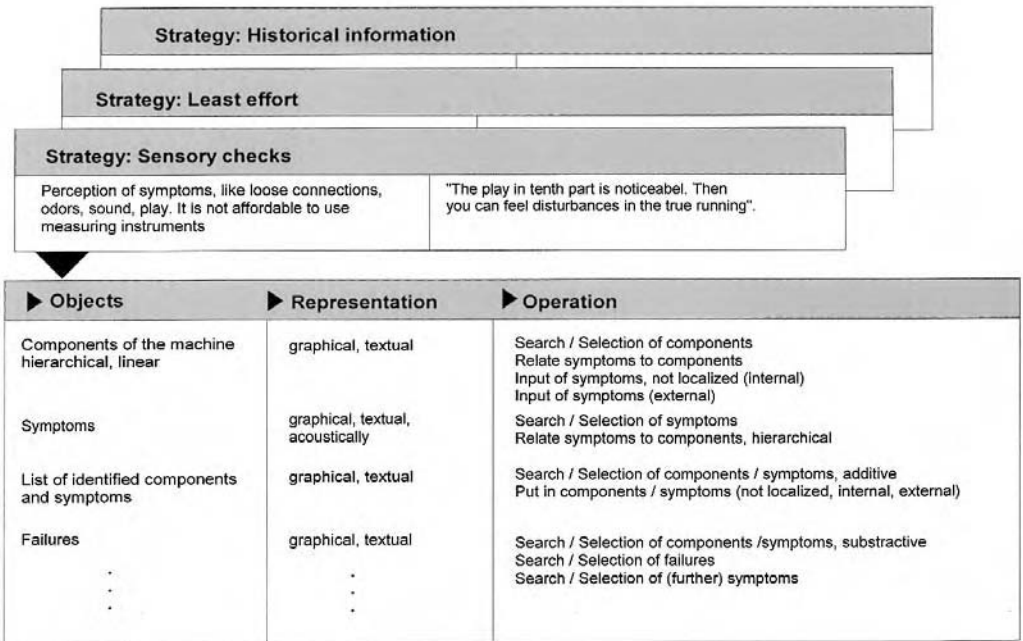

FIGURE 24.6 Three stages of strategy-based software design. The strategy: Sensory checks require the implementation of objects, type of representation and of operation (From Konradt, U. (1995). Strategies of failure diagnosis in computer-controlled manufacturing systems: Empirical analysis and implications for the design of adaptive decision support systems. *International Journal of Human-Computer Studies*, 43, pp. 503-521. With permission.)

whose connections arise out of the individual strategies. The resulting network offers the user the chance to switch between different strategies or combine them with each other.

A final usability study concerning the proposed efficiency and the use of different types of information related to different strategies are presented in the next section.

Understanding the Usefulness of the Application: Usability Study

During the design cycle, the Diagnosis Information System (DIS) was continuously refined by user participation. At the stage of a smoothly running prototype, an intensive usability study has been conducted with respect to efficiency, enhancement of users' knowledge, flexibility of the system, and user acceptance. In this chapter, results on efficiency and flexibility in comparison with a manual will be presented. Additional results are outlined in Majonica and Zimolong (1994) and Majonica (1996).

An overview on the study is given in Figure 24.7. It was carried out with 60 subjects in cooperation with work-training centers, and small metal-manufacturing and automobile manufacturing companies. Age of participants was between 17 and 62 years; average was 29 years. Mean professional experience was 7 years; 35% of the subjects had experience with CNC-machine tools, 65% had none. Ten subjects (17%) conducted failure diagnosis tasks at CNC-machines in their own company. No one was familiar with the specific type of CNC-machine used in this study.

The study consisted of five parts: (1) introduction of DIS or manual and exercises; (2) first knowledge test; (3) individual solution of five diagnostic tasks; (4) second knowledge test, and finally (5) overall assessment of the system. The total efficiency of the system was tested with a control-group design. Forty subjects used DIS as a tool to solve five diagnostic tasks, and 20 subjects used the manual, which contained the equivalent information. Between three and ten solutions had to be found for each of the five different tasks. Subjects spent more than three hours on the study. Knowledge tests and assessment of the system were presented as paper and pencil tests. Log-file data were automatically recorded. Analysis of data

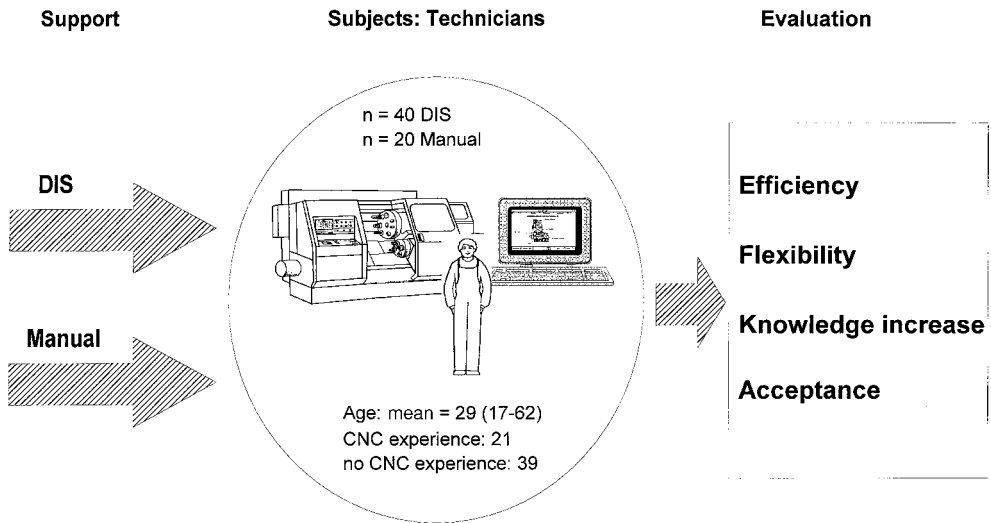

FIGURE 24.7 Design of the usability study. DIS = Diagnosis Information System; manual of the system.

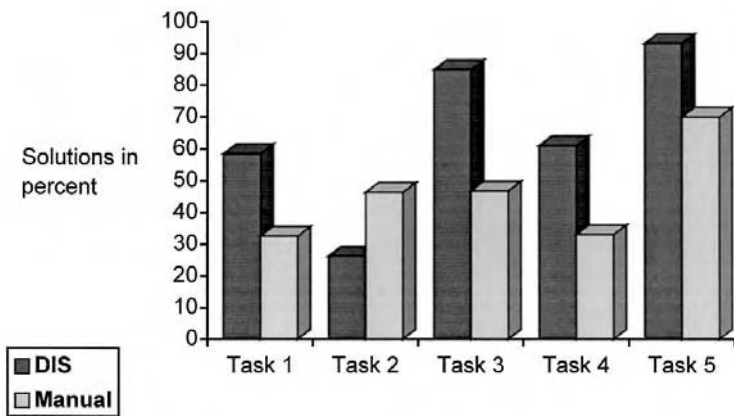

FIGURE 24.8 Frequency of solutions obtained with the support of DIS or manual. Except for task 2, subjects performed better with DIS.

allowed investigators to identify the frequency of use of the system pages and to compute the amount of time spent per page within the four modules of DIS. The use of the manual was recorded with a videorecorder and after that analyzed with respect to frequency and time spent with different pages and chapters.

Total efficiency was measured as frequency of solutions obtained with DIS and manual (Figure 24.8). Except for task 2, subjects gained better results with DIS. They solved 65% of the tasks as compared to 46% of tasks in the manual condition. Results of the efficiency analysis show that DIS significantly improves the correct solutions of the diagnostic tasks. Compared with the use of a manual, 19% more correct solutions were found on average. Only in task 2 the manual was superior. Without task 2 there was a gain of 29% in performance against the manual.

No difference could be found between the two samples with respect to experience with troubleshooting or professional experience. As an important result, DIS offers equally good support to both users with domain-specific knowledge and beginners: there was no difference in the number of solutions found by the two groups.

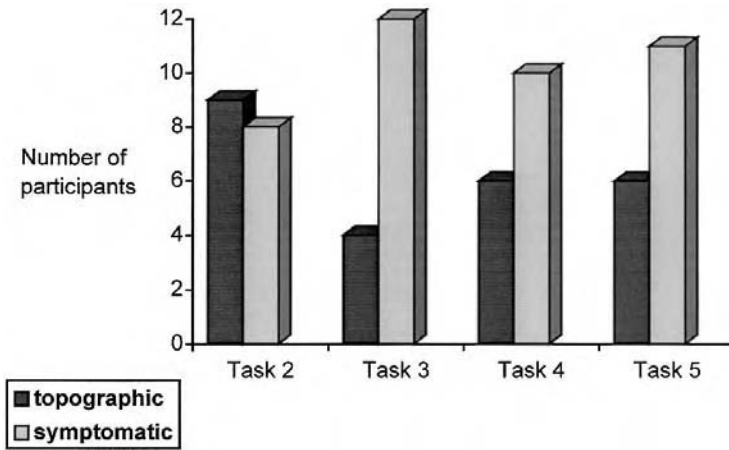

FIGURE 24.9 Strategies of participants.

Psychological flexibility of a system means the degree of support a system offers to foster the application of individual strategies and cognitive preferences of users. The flexible use of the system was measured as frequencies and amount of time spent with the different modules of DIS or with different chapters of the manual to solve the diagnostic tasks. Significantly more time was spent with the four modules of DIS as compared to the equivalent chapters of the manual. Users more often switched back and forth from one module to the next, performing significantly more transitions between modules ($x = 3.44$) as compared to the transitions between chapters of the manual ($x = 1.17$).

Finally, the flexibility of the system was evaluated. Log-file data of 19 subjects were analyzed with respect to the transitions from one page of the system to the next one. The various steps of the individual solution paths of four tasks were identified separately for each subject. The steps served as entries of a cluster-analysis which was computed with respect to an analysis of the main strategies “topographic,” “symptomatic,” and “case-based” search. Results showed that seven of the participants pursued a topographic strategy, and twelve a symptomatic strategy. No case-based strategy was found. Five users switched from topographic to symptomatic search and vice versa while performing their analysis. One of the strategies could not be identified. Thus, the system not only supports different strategies of the users but also allows switching between different strategies (Figure 24.9).

Results of the usability study demonstrated that users with different backgrounds in professional as well as in diagnostic experience were equally well supported by DIS. The system allowed them to choose their own way of solving the tasks. Data from questionnaires show that they also improved their knowledge about the machine structures, components, and failure causes. No case-based strategy was found. This is probably due to the characteristics of the sample. Subjects were not familiar with this specific type of CNC-machine and therefore could not use their experience with previous failures and breakdowns. The usability study showed very clearly the advantages of the psychological requirement analysis and the strategy-based software design. SSD strongly improved the efficiency of the system, supported the personal strategies of the participants, and led to an overwhelming acceptance of the system by the users.

24.4 Conclusions

This chapter has presented an overview of an integrated approach to software design that considers relevant organizational, human, and technical issues in software development. The software development process starts with an analysis and understanding of business and market requirements. Process-oriented task analysis considers at an early point in the software design cycle the organizational, functional, and

psychological aspects of work. Three field studies were reported, covering these aspects. First, organizational aspects of decentralized manufacturing units and semiautonomous work groups were studied. In particular, the allocation of functions to the units with respect to planning, scheduling, maintenance, and repair were discussed. From this analysis, requirements of information flow and decision support for work groups were derived. Second, a task analysis with special emphasis on cognitive preferred working methods of maintenance personnel was performed. The study revealed 14 strategies, rules, and procedures on how maintenance personnel performed troubleshooting activities. The message from the findings was that in order to support these strategies efficiently, all information required has to be stored in the DSS. This procedure is called "strategy-based software design." Data structures are derived through specification of a set of semantic objects that are necessary to carry out one of the strategies. Finally, a usability study revealed the usefulness and efficiency of the approach.

An empirically oriented and practically applicable theory of design that covers business processes, principles of sociotechnical design, such as cooperative work and user participation, and information technology which is sufficiently detailed, simple, and structured is still outstanding. In our approach an integrated attempt has been made to identify, connect, and handle some important structural variables that may improve a unified understanding toward design and application of computer-based working tools. In this way it can be treated as a reference model for a future generation of flexible software support systems.

References

- Brödner, P. (1990). *The Shape of Future Technology. The Anthropocentric Alternative*. Springer, New York.
- Clegg, C. and Symon, G. (1989). A review on human-centred manufacturing technology and a framework for its design and evaluation. *International Review of Ergonomics*, 2, pp. 15-47.
- Corbett, J.M., Rasmussen, L.B. and Rauner, F. (1991). *Crossing the Border. The Social Engineering Design of Computer Integrated Manufacturing Systems*. Springer, London.
- Fix-Sterz, J., Lay, G. and Schultz-Wild, R. (1986). *Flexible Fertigungssysteme und Fertigungszellen*. VDI-Z, 128, pp. 369-379.
- Hammer, M. and Champy, J. (1993). *Reengineering the Corporation*. New York, Harper Collins Publ.
- Imai, K. (1994). *Kaizen: Der Schlüssel zum Erfolg der Japaner im Wettbewerb*. Berlin/Frankfurt, M. Ullstein.
- Kidd, P.T. (1994). *Agile Manufacturing: Foregoing New Frontiers*. Addison-Wesley, Reading.
- Konradt, U. (1995). Strategies of failure diagnosis in computer-controlled manufacturing systems: Empirical analysis and implications for the design of adaptive decision support systems. *International Journal of Human-Computer Studies*, 43, pp. 503-521.
- Konradt, U. (1996). *Gestaltung gebrauchstauglicher Anwendungssysteme*. Wiesbaden, Deutscher Universitäts-Verlag.
- Konradt, U. and Zimolong, B. (1993). Arbeitstätigkeiten, Qualifikationsanforderungen und Organisationsformen an CNC-gesteuerten Werkzeugmaschinen und Bearbeitungszentren. *Zeitschrift für Arbeitswissenschaft*, 47, pp. 71-78.
- Majonica, B. (1996). Evaluation eines Informations-Systems für die Unterstützung von Instandhaltungsaufgaben. Münster, Waxmann.
- Majonica, B. and Zimolong, B., (1994), Evaluation of a diagnosis information system for semi-autonomous production islands, in *Proceedings of IEEE International Conference on Systems, Man, and Cybernetics*, San Antonio, Texas, pp. 741-746.
- Monarchi, D.E. and Puhr, G.I. (1992). A research typology for object-oriented analysis and design. *CACM*, 35(9), pp. 35-47.
- Ostendorf, B. and Seitz, B. (1992). Alte und neue Formen der Arbeitsorganisation und Qualifikation — Ein Überblick, in J. Schmid and U. Widmaier (Eds.). *Flexible Arbeitssysteme im Maschinenbau*. Opladen, Leske + Budrich, 1992, pp. 75-89.

- Rasmussen, J. (1981). Models of mental strategies in process plant diagnosis, in J. Rasmussen and W. B. Rouse (Eds.), *Human Detection and Diagnosis of System Failures*. Plenum Press, New York, pp. 241-258.
- Shah, R. (1987). Flexible Fertigungssysteme in Europa. *Verfahren der Anwender*. VDI-Z, 129, pp. 13-21.
- Zimolong, B. (Ed.) (1996). *Kooperationsnetze, Teilautonome Flexible Fertigungsstrukturen und Gruppenarbeit*. Opladen, Leske + Budrich.
- Zimolong, B. and Duda, L. (1992). Human error reduction strategies in advanced manufacturing systems, in M. Rahimi and W. Karwowski (Eds.), *Human-Robot Interaction* (pp. 242-265). London: Taylor & Francis.
- Zimolong, B. and Saurwein, R.G. (1995). Maschinenbau zwischen CIM und Gruppenarbeit. *Zeitschrift für Arbeitswissenschaft*, 21 (4), pp. 226-232.
- Zimolong, B. and R. Trimpop (1994). Managing human reliability in advanced manufacturing systems, in G. Salvendy and W. Karwowski (Eds.). *Design of Work and Development of Personnel in Advanced Manufacturing*. Wiley, New York, pp. 431-461.

Section II

Manufacturing Systems

25

Kansei Engineering: A New Consumer- Oriented Technology for Product Development

25.1	Introduction	25-1
25.2	Types of Kansei Engineering.....	25-2
	Type I: A Category Classification • Type II: Kansei Engineering Computer System • Type III: Kansei Engineering Modeling • Type IV: Hybrid Kansei Engineering • Type V: Virtual Kansei Engineering	
25.3	Applications of Kansei Engineering	25-6
	Applications of Type I • Applications of Type II • Applications of Type III • Applications of Type IV • Application of Type V	

Mitsuo Nagamachi
Hiroshima University

Abstract

Kansei Engineering was developed as a consumer-oriented technology for new product development. It is defined as “ergonomic translation technology of the consumer’s feeling and image of a product into physical design elements including mechanical function.” Kansei Engineering (KE) technology is classified into five types, KE Types I through V. KE Type I is a category classification of the new product toward the design elements. Type II utilizes the current computer technologies such as Expert System, Neural Network Model, and Genetic Algorithm. Type III is concerned with a mathematical modeling of Kansei Engineering. Type IV consists of two sorts of Kansei Engineering, forward and backward reasoning systems; and finally Type V utilizes a combination of virtual reality technology and Kansei Engineering.

Kansei Engineering has permeated Japanese industries, including automotive, home electric appliance, construction, clothing, and so forth. The successful companies using Kansei Engineering benefited from good sales due to the new consumer-oriented products.

25.1 Introduction

Currently, the industrial age is changing from “a product-out concept” to “a market-in concept” regarding new product development. In the 1970s, manufacturers produced a volume of products and people bought them. At that time, the manufacturers designed the products according to their own concept and strategy. However, the consumers had to buy them regardless of their personal preferences. At present, they have a lot of things at home they do not want anymore. Sophisticated consumers desire products that match their own feelings of design and functional requirements as well as price.

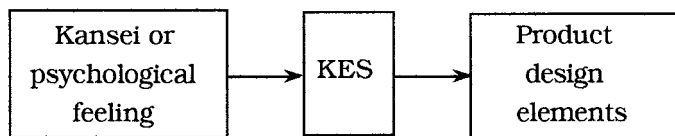

FIGURE 25.1 A diagram of a process of the Kansei Engineering System.

The product-out strategy means production by a manufacturer based on its own design strategy regardless of the consumer's demand and preference. On the other hand, the market-in strategy implies production based on the current consumer's desire and preference. Nowadays, consumers are stringent in choosing products in terms of their demand and preference. The manufacturers should change their production strategy and attitude to a more consumer-oriented one.

Nagamachi developed Kansei Engineering as an ergonomic consumer-oriented technology for new product development (Nagamachi, 1986; 1988a, b, c; 1989a, b; 1990a, b; 1991a, b; 1993a, b, c; 1994a, b, c, d; 1995a, b; Nagamachi et al., 1974; 1977; 1985; 1986; 1987; 1988; 1989, Enomoto et al., 1993, 1995; Fukushima et al., 1995; Imamura et al., 1994; Ishihara et al., 1993a, b; 1994; 1995; Jindo et al., 1991; 1995; Matsubara et al., 1994a, b; 1995; Tsuchiya et al., 1995). Kansei is a Japanese term which means a consumer's psychological feeling and image regarding a new product. When a consumer wants to buy something, he or she has an image of the product, such as "luxurious, gorgeous, and stable." Kansei Engineering technology enables his or her image and feeling to be used in the new product and to produce a good product that fits the customer's image. Kansei Engineering is defined as "translating technology of a consumer's feeling (Kansei) of the product into the physical design elements," as shown in Figure 25.1.

Kansei Engineering aims to produce a new product based on the consumer's feeling and demand. There are four points concerning this technology; (1) how to grasp the consumer's feeling (kansei) about the product in terms of ergonomic and psychological estimation, (2) how to identify the design characteristics of the product from the consumer's kansei, (3) how to build a Kansei Engineering system as an ergonomic technology, and (4) how to adjust the product design to the current societal change in people's preferences.

Concerning the first point, we use the semantic differentials (SD) developed by Osgood and his colleagues (Osgood et al., 1957) as a main technique to grasp the consumer's kansei. In Kansei Engineering, we collect the kansei, or the consumer's words, from shops and from industrial magazines. At first, we collect 600 through 800 kansei words and then select approximately 100 of the most relevant words.

In regard to the second point, we conduct a survey or an ergonomic experiment to look at the relation between the kansei words and the design elements. Regarding the third point, we utilize advanced computer technologies to build a systematic framework of the Kansei Engineering technology. Artificial intelligence, neural network model, and genetic algorithm as well as fuzzy set theory are utilized in the Kansei Engineering computerized system to construct the concerned databases and the inference system. Finally, we attempt to maintain the fit of the databases of the Kansei Engineering system and the consumer's current kansei trend by inputting new kansei data from the consumer every three or four years.

25.2 Types of Kansei Engineering

There are five technical styles of Kansei Engineering; Type I through Type V. Type I Kansei Engineering means Category Classification from zero to n th category. Type II uses a computer-aided system. Type III utilizes a mathematical framework to reason the appropriate ergonomic design. Type IV refers to Kansei Engineering system constructed by forward and backward reasoning, and Type V combines Kansei Engineering technology with virtual reality.



FIGURE 25.2 Miata made by Mazda.

Type I: A Category Classification

The category classification is a method by which a kansei category of a planned target is broken down in a tree structure to determine the physical design details. The following is a good example of the application of Kansei Engineering Type I. A Japanese car maker, Mazda, developed a sports car named “Miata” (Eunos Roadster in Japanese) (Figure 25.2) which was derived from Kansei Engineering. Kenichi Yamamoto, the chairman of Mazda was much interested in this new ergonomic technology (Yamamoto, 1986). As a result, Nagamachi was asked to teach Kansei Engineering to Mazda’s development engineers and often visited Mazda. Mazda’s people came to Hiroshima University to discuss Kansei Engineering. At present, Kansei Engineering has become the fundamental technology for new product development at Mazda.

Mr. Hirai, a manager of a new brand car, and his project team decided to implement Kansei Engineering in the development of Miata and based the zero-level category of the new model “Human–Machine Unity,” after a vast market survey and analysis of young drivers maneuvering. This concept, HMU, implies that a young driver feels a unity between himself or herself and the car when driving. The driver feels that his or her body might be unified with the car and controls the machine as if controlling his or her own body freely. Human–Machine Unity at the start of Kansei Engineering is just the concept of a new brand car. It tells nothing about the car design details such as engine type, car size, exterior design, interior design, and so forth. In Kansei Engineering Type I, the zero-level concept should be broken down into clearly meaningful subconcepts to determine the real design details.

The project team members started to classify the zero-level concept into the subconcepts, that is, 1st, 2nd, ..., and n th subconcept until they obtained the car design specifications. The procedure used in Type I category is shown in Figure 25.3. In regard to Miata, the zero-level kansei was classified into four subconcepts in the first level; “Tight-feeling,” “Direct-feeling,” “Speedy-feeling,” and “Communication.” Tight-feeling implies the feeling of “fitting closely to the machine and “neither large nor small.” With this subconcept, the team decided that the car length should be around 4 m, based on experience in car development. As a result, it was set at as 3.98 m due to the chassis length. If four seats would be mounted in this car, the driver would feel “narrow” and this feeling would not fit in with the subconcept. So it was decided that Miata would be a two-seat sports car. The above-mentioned story is an example of how the concepts were broken down into more detail until the team reached the final physical design elements.

Figures 25.3 and 25.4 explain how the Type I procedure is transferred into the subconcepts to the design detail. Figure 25.3 shows the breakdown procedure of “Tight-feeling” into physical traits. Figure 25.4 illustrates the translation of kansei concepts into physical traits, ergonomic specifications,

Kansei				Physical traits	Ergonomic experiment	Automotive engineering
Zero	1st	2nd	nth			
HMU	Tight feeling	[• • • •	Size	Tight feeling	Chassis design
			• • • •	Width	experiment	Sheet design
			• • • •	Height	Interior kansei	Interior design
	Direct feeling	[• • • •	Seat	experiment	Power train
			• • • •	Steering design	Steering function	development
			• • • •	Shift lever	Shift lever	Steering yaw ratio
	Speedy feeling	[• • • •	Speed meter	length	Steering design
			• • • •	Frequency	Minus gravity	Shift lever design
	Communication	[• • • •	Open style	Noise frequency analysis	Speed meter design
			• • • •			exhaust pipe design
			• • • •			

FIGURE 25.3 The translation of kansei into car physical traits in the case of the Miata.

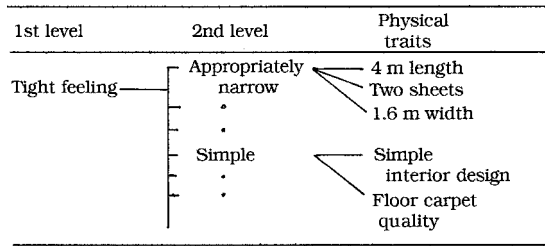

FIGURE 25.4 An example of refining the physical traits from kansei subconcepts.

and automotive engineering designing. The physical traits decided upon according to this breakdown procedure are tested ergonomically to find ergonomic specifications, which will be explained later. Then, the automotive engineering development and design attempt to realize the ergonomic characteristics. In this stage, the team creates a great number of new patents.

Mazda’s project team succeeded in developing the new sports car, Miata, and it became a best-seller in the U.S. as well as in Japan. Miata is a typical example of the application of Kansei Engineering Type I.

Type II: Kansei Engineering Computer System

Kansei Engineering Type II is a computer-aided system concerning Kansei Engineering. Kansei Engineering System (KES) is a computerized system with an Expert System that supports the transfer of the consumer’s feeling and image into physical design elements. The KES basically has four databases and an inference engine in the structure, shown in Figure 25.5.

Kansei Databases

First of all, kansei words used in a new product domain are collected from shops or from the concerned industrial magazines. These are mostly adjectives and sometimes nouns. If it is concerned with a passenger car, customers use words such as “speedy,” “easy control,” “gorgeous,” “highly qualified,” etc. These kansei words are analyzed by multivariate analysis like factor analysis, cluster analysis, and others, after an ergonomic evaluation has been conducted. The Kansei database consists of these statistically analyzed data. Kansei Engineering evaluation is mostly conducted through the Semantic Differential (SD) Method with five-point scaling.

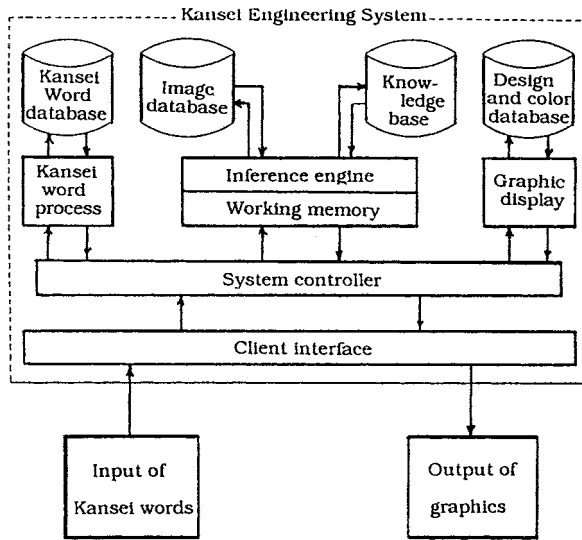

FIGURE 25.5 A system structure of the Kansei Engineering System.

Image Database

The data evaluated by the SD scale are analyzed by Hayashi’s Quantification Theory Type II (Hayashi, 1976), which is a type of multiple regression analysis for qualitative data. After this analysis, we are able to construct the statistical relations between the kansei words and the design elements. This is the image database. Hence, we can identify the contributory items in the design elements to specific kansei words and vice versa. For instance, if a consumer or a designer wants to decide the design fit to “speedy feeling,” he or she checks the image database inputting these words into the system and finds the design element most contributory to this feeling.

Knowledge-Base

The knowledge-base consists of a group of rules in the form of “if, then” and the rules for controlling the image database. It also includes the color conditioning principle, the round design guideline, and so forth.

Shape and Color Databases

The design details are implemented in the shape design database and in the color painting database, separately. All design details consist of the aspects of design that are correlated as a total shape with each kansei word. The color database consists of full colors that are also correlated to the kansei words. The combined design with shape and colors is extracted by the specific inference system based on the rule-base and displayed in graphics on the screen.

Type III: Kansei Engineering Modeling

Kansei Engineering Type III utilizes a mathematical modeling constructed in the computerized system in spite of the rule-base. In this technique, the mathematical model works as if it is a kind of logic like the rule-base.

Sanyo Electric Co. attempted to implement kansei fuzzy logic as machine intelligence in a color printer (Fukushima et al., 1995). The intelligent color printer consisted of a camera, a computer, and a color printer system with fuzzy logic and was able to diagnose the color of the original picture to print out the more beautiful color picture in terms of fuzzy logic. Nagamachi has developed a computerized diagnosis system about Japanese language feeling in terms of fuzzy integral and fuzzy measure logic

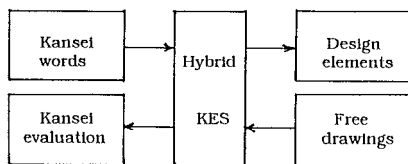

FIGURE 25.6 A diagram of Hybrid Kansei Engineering System.

(Nagamachi, 1993c). This is utilized to diagnose brand name feeling, and several Japanese companies use this system to select a good-feeling name for new products.

Type IV: Hybrid Kansei Engineering

Kansei Engineering Type II is a computerized KES to help a customer decide on a product that has the best fit for his or her product feeling, as shown in Figure 25.1. In Type II, the flow of kansei translation is from the customer's kansei to the design details. The designers can also use this style to decide the design. If he or she wants to design a kansei product from the viewpoint of "market-in strategy," the designer settles his or her design image of the new product first, and then he or she is able to identify the design specifications of the product with support of the KES. This direction is named "forward Kansei Engineering."

However, the designer sometimes wants to know how well his or her image and design fit the kansei. This computerized suggestion gives the designers good suggestions on how to create his or her design much more than the Type II can do. This direction is called "backward Kansei Engineering." Figure 25.6 shows both kansei translation directions in kansei engineering. The combination is called "Hybrid Kansei Engineering."

Using the Hybrid Kansei Engineering System, a designer is able to get the design specifications from the kansei words through the Forward Kansei Engineering. From the output displayed by the system, the designer designs more creatively based on his or her own idea and refers to the suggestion given by the system. Then, the designer inputs his or her new sketch of the product into the system, and the Backward Kansei Engineering recognizes the designer's sketch by means of an image recognition system. Finally, the system diagnoses the inputted sketch with reference to the kansei database, and the designer can evaluate his or her own sketch that has been formed by his or her creative sense.

Type V: Virtual Kansei Engineering

Kansei Engineering Type V is a new technique combining kansei engineering and virtual reality technology. Virtual reality is now a very popular technology in which people can virtually walk through the design created by the computer and displayed by means of HMD (Head Mounted Display) and data gloves.

In this technique, the kansei environment including the new product is constructed in the system, and the customer is invited to the virtual space with the new product. The virtual space and the product are decided by kansei engineering. Therefore, the customer can check the new product inside the virtual space. For instance, Nagamachi constructed a virtual kansei engineering kitchen system with Matsushita Works Co. (Nagamachi et al., 1996). In this system, the kitchen is designed by the kansei engineering system to fit the customer's kitchen image, and then the customer walks through the computer graphics and evaluates the virtual kitchen with reference to his or her image.

25.3 Applications of Kansei Engineering

Applications of Type I

Applications to the Automotive Industry

We have some applications of Kansei Engineering Type I in the automotive industry. The first application of kansei engineering in Japan has been conducted by Mitsubishi Motors Co. Mitsubishi applied kansei

engineering technology to the dashboard design of a passenger car. Mazda implemented kansei engineering in the interior design of the Persona, in which case Mazda has introduced the concept of “Interiorism.” This means to implement the atmosphere of a house reception room with sofas inside a vehicle. Mazda next tried to implement the complete technique and methodology of kansei engineering in the development of Miata. Therefore, as mentioned above, Miata exhibits many applications of kansei engineering.

When deciding the shift-lever length of Miata, for instance, the concern has been mainly the driver’s kansei or feeling of “self-controlling the car.” Then Mazda conducted an ergonomic experiment in which the subjects consisting of the designers and researchers had to estimate a variety of shift-lever lengths on the SD scale of the “self-controlling” feeling. After the calculation of experimental results, they noticed that the shift-lever length should be 9.5 cm to satisfy the driver’s “self-controlling” feeling. This is just an example of the application of kansei engineering. After Miata’s success, the kansei analysis became important at Mazda. Now, Mazda generally starts from the kansei concept construction for every new product.

Wacol Co., which is a well-known maker of ladies’ lingerie, tried to introduce kansei engineering in developing a new brassiere. As in the procedure for Miata, it tried to settle the first concept for the new brassiere from a survey of 2,000 women. From the questionnaire, Wacol found that their aim was to be “beautiful” and “elegant.” However, the findings did not apply to design details. Then, Wacol invited all subjects to its ergonomic laboratory and asked them to wear a variety of test brassieres and to estimate them on the “beautiful” and “elegant” SD scale. The experimental results were analyzed through Quantification Theory Type I, and Wacol succeeded in finding the physical traits regarding the new brassiere; that is, (1) the breasts when wearing the brassiere should be kept within both body lines, and (2) two nipples should be in parallel and a little upward. Wacol endeavored to realize these two principles using the new materials and design. Wacol found after many trials that amorphous fiber would be best for women’s very soft breasts and designed the brassiere to pull the breasts toward a central position.

Figure 25.7 shows the estimated results analyzed by the moiré-topography of a popular and finally designed brassiere. The lower silhouette in Figure 25.7 illustrates the popular brassiere moiré and the upper one represents the new brand moiré.

The upper figure satisfies two principles of a kansei brassiere, that is, the two breasts are kept within both body lines and the nipples are directed toward the reader’s face. This was named “Good-up Bra” and has succeeded in achieving the highest sales record.

Applications of Type II

Kansei Engineering Type II is a computer supporting system for a designer designing kansei products. The KES utilizes expert system and neural networks, as well as genetic algorithm as the knowledge engineering technologies.

Figure 25.5 illustrates an example of KES, which has the kansei word, image, form, and color databases, and knowledge-base as well. When a designer inputs his or her kansei words in the system, the KES calculates them through the inference engine using the databases, and outputs a graphic as the outcome of system calculation. Figure 25.8 shows an example of (painted) kitchen design produced by the KES, which is called HULIS, HUMan LIVING System (Nagamachi, 1991a). The KES has been applied to the design of a house, costume, aluminum entrance door, passenger car interior, construction machine interior, and so forth.

Applications of Type III

Kansei Engineering Type III implies a mathematical modeling of KES. A good example of this was developed by Sanyo Co. Sanyo attempted to develop a new style of an intelligent color printer which enables production of a more beautiful picture than the original one. In general, the color copy machine faithfully prints the original picture. However, this new type of color printer can change, for example,

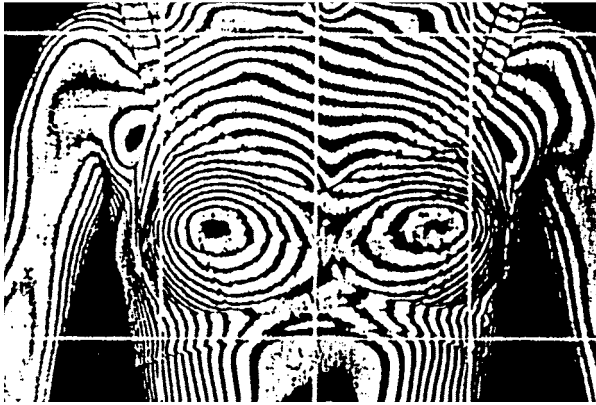

FIGURE 25.7 The lower figure is the moiré-topography for ordinary brassiere and the upper for the new brand one.

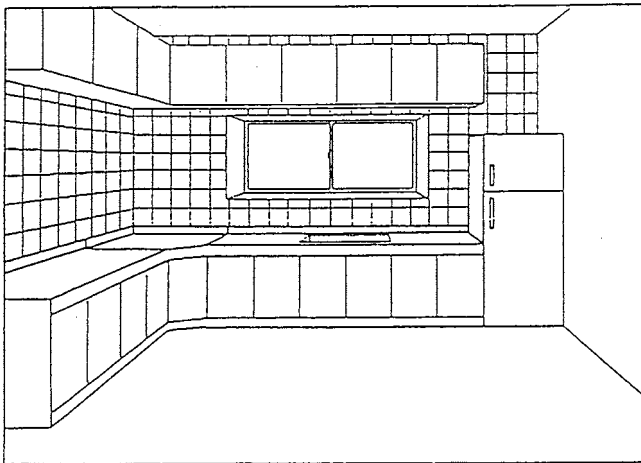

FIGURE 25.8 The displayed “kitchen” (painted) outputted by HULIS.

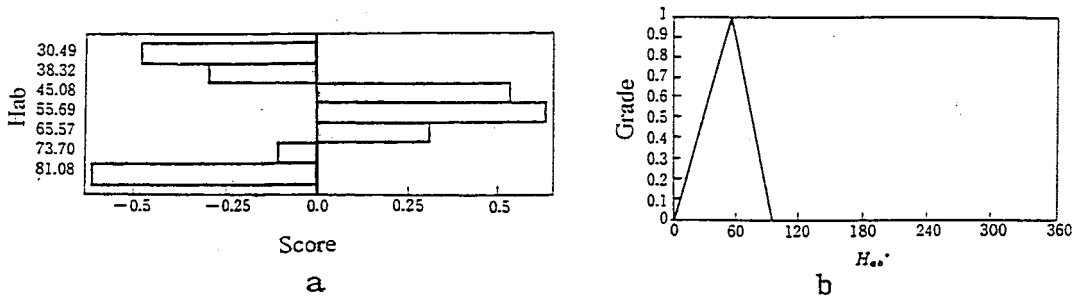

FIGURE 25.9 The experimental result of hue of face color (a) and the triangle Fuzzy expression of Fuzzy Membership Function of it (b).

face color to be more beautiful, because it has an intelligent system to recognize the face color and changes it in terms of a mathematical structure.

The KES color printer of Sanyo consists of a camera, image scanner, CPU recognition system, and color print system. We conducted ergonomic research on face color analysis using the SD scale. Sanyo researchers as the subjects evaluated a variety of face colors on the 5-point scale of “healthy and beautiful,” and we found kansei dimensions of hue, brightness, and saturation concerning face color could be represented by a triangle fuzzy membership function of fuzzy set theory, as shown in Figure 25.9.

The tuning system of face color was implemented in the CPU of the new color copy machine, and we succeeded in producing healthier looking and more beautiful color copy (see Fukushima et al., 1995).

Nagamachi also used fuzzy logic structure as a model to diagnose Japanese word feeling. The new computerized word diagnosis system, WIDIAS, Word Intelligent DIAGnosis System, was developed at Hiroshima University using kansei engineering technology, and it has been used in Japanese companies to select appropriate brand names for newly developed products (Nagamachi, 1993c).

Applications of Type IV

The KES, in general, implies a decision procedure, kansei engineering, from the input of kansei words to the output of design details. However, a designer sometimes desires to have an assessment of his or her creation with reference to kansei engineering output.

The KES Type IV, Hybrid Kansei Engineering has two directions, Forward Kansei Engineering which means the flow of KES from kansei words to design details, and Backward Kansei Engineering which means the procedure flows from the designer’s creation with reference to the output due to Forward KES to the assessment of feeling about his or her design creation. Figure 25.6 illustrates the Hybrid Kansei Engineering System. The upper flow of Hybrid KES is the procedure used to find kansei design details by inputting kansei words. The lower represents an opposite direction, from the designer’s sketch toward the assessment or diagnosis of the designer’s sketch. The designer can get a final decision about the new product design after cyclic usage of the Forward KES and the Backward KES.

Figure 25.10 shows the Backward KES. It has a computerized image recognition system which recognizes the inputted sketch created by the designer. It also has an assessment system which is able to evaluate the inputted sketch with reference to kansei databases. A Hybrid KES computer system is shown in Figure 25.11 which is a combination of KES (the Forward KES) shown in Figure 25.5 and the Backward KES shown in Figure 25.10 (Matsubara and Nagamachi 1995). Hybrid KES is utilized at Nissan for designing steering wheels and at Komatsu for designing a construction machine interior. For instance, Nissan uses Forward KES to get design details for a steering wheel, and the designer creates a more up-to-date design with reference to the KES conclusion. Then the designer inputs his or her sketch of the new steering wheel in to Hybrid KES. It evaluates the designer’s sketch based on Hybrid KES rule-base and presents the kansei evaluation to the designer according to Backward inference.

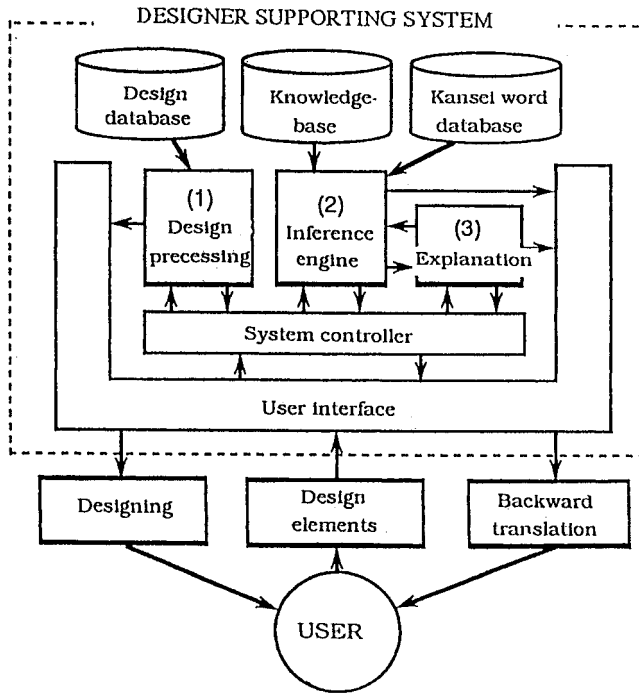

FIGURE 25.10 A diagram of the Backward Kansei Engineering System.

Figure 25.12 illustrates the use of the Backward KES for a steering wheel conducted at Nissan. The sketch created by a designer was inputted into the Hybrid KES by an automatic image recognition system (the right side in the figure) or a menu procedure (the left side of the figure). The system constructed a list of sketched design characteristics and diagnosed the kansei level of the sketch using the kansei diagnosis indices, with 0.0 to 1.0 applied to each kansei word, shown in the lower figures in Japanese in Figure 25.12.

Application of Type V

Virtual reality technology is well known about realization of virtual experience. We attempted an integration of virtual reality and kansei engineering regarding a house kitchen design, which is called Virtual Kansei Engineering. The Virtual KES is able to select a kitchen style in terms of a computer system with kitchen databases, when a customer addresses his or her height data and life style concerning kitchens. After that, the customer can walk through the computer graphics of the virtual kitchen to check whether it fits his or her image and feeling about the kitchen (Enomoto et al., 1993).

The Virtual KES is utilized in Matsushita Electric Works sales shops, in Tokyo, Osaka, and Hiroshima, Japan, and it has good reputation among customers.

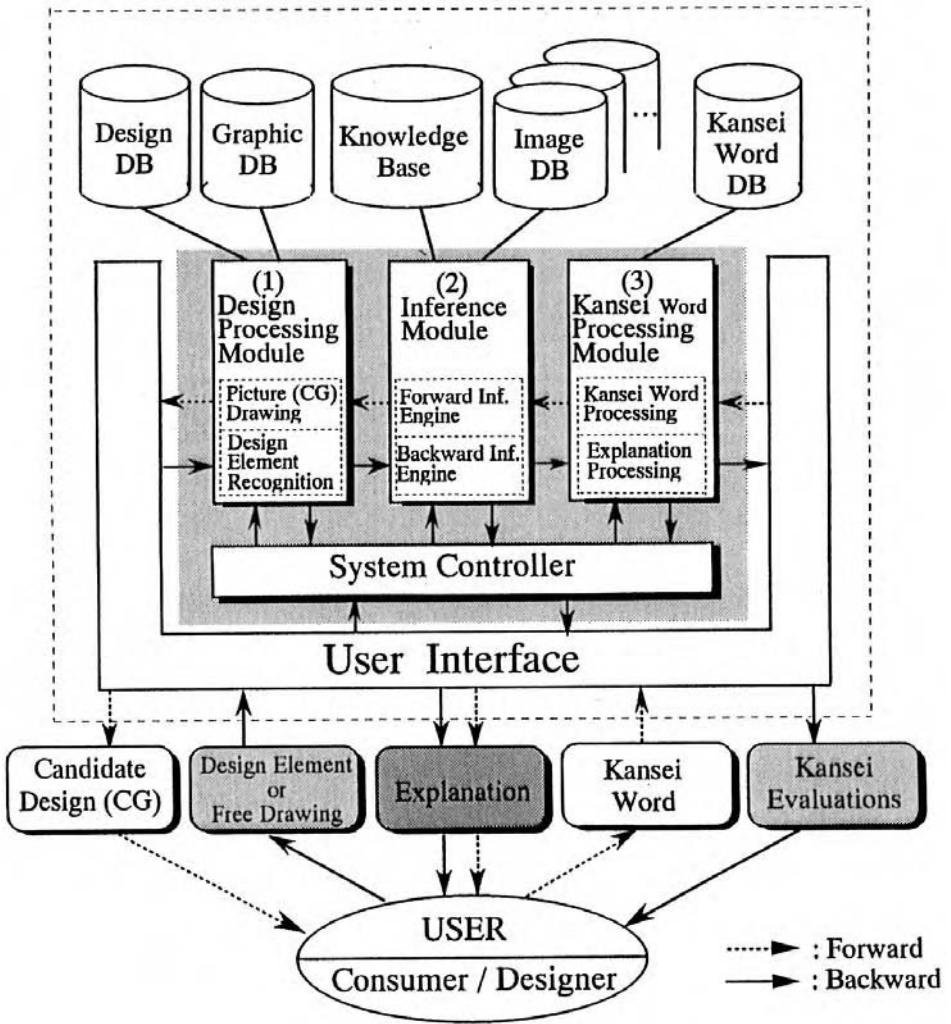

FIGURE 25.11 A diagram of the Hybrid Kansei Engineering System.

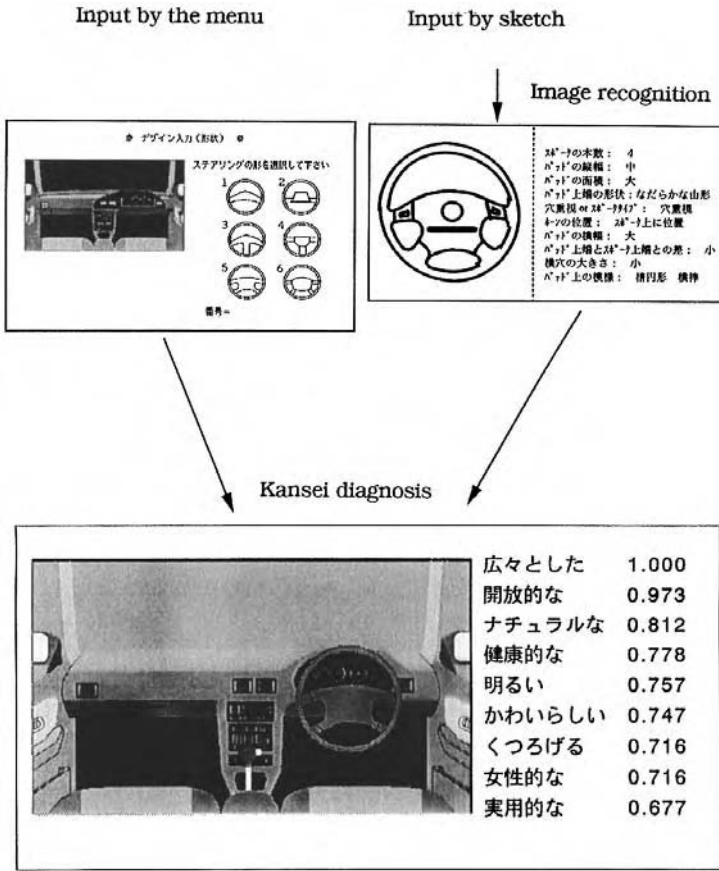

FIGURE 25.12 An example of Hybrid KES applied to steering wheel design. The inputted sketch is diagnosed to the kansei implication in terms of Hybrid KES.

References

- Enomoto, N., Nagamachi, M., Nomura, J. and Sawada, K., 1993, Virtual kitchen system using Kansei Engineering, in *Human Computer Interaction: Software and Hardware Interface*, G. Salvendy and M.J. Smith (Eds.) (Elsevier, Amsterdam), pp. 657-662.
- Enomoto, N., Nomura, J., Sawada, K., Imamura, K. and Nagamachi, M., 1995, Kitchen planning system using Kansei Virtual Reality. *Symbiosis of Human Artifact*, 179-184.
- Fukushima, K., Kawata, H., Fujiwara, Y. and Genno, H., 1995, Human sensory perception oriented image processing in color copy system. *International Journal of Industrial Ergonomics*, 15(1), 63-74.
- Hayashi, C., 1976, *Method of Quantification*, Toyokeizai, Tokyo.
- Imamura, K., Nomura, J., Enomoto, N. and Nagamachi, M., 1994, Virtual space support system using kansei engineering, in *Japan-USA Symposium on Flexible Automation*, pp. 549-555.
- Ishihara, S., Hatamoto, K., Nagamachi, M. and Matsubara, Y., 1993a, ART1.5SSS for Kansei Engineering Expert System, in *Proceedings of International Joint Conference on Neural Networks*, pp. 2512-2515.
- Ishihara, S., Ishihara, K. and Nagamachi, M., 1993b, AKSYONN: Automated kansei engineering expert system builder by self-organizing neural network, in *Human Factors in Organizational Design and Management-IV*, pp. 485-490.
- Ishihara, S., Ishihara, K., Nagamachi, M. and Matsubara, Y., 1994, Automatic analysis on Kansei Engineering experiment by self-organizing neural network, in *Japan-USA Symposium on Flexible Automation*, pp. 541-544.

- Ishihara, S., Ishihara, K., Nagamachi, M. and Matsubara, Y., 1995, An automatic builder for a kansei engineering expert system using self-organizing neural networks. *International Journal of Industrial Ergonomics*, 15(1), 13-24.
- Jindo, T. and Nagamachi, M., 1991, The development of a car interior image system incorporating knowledge engineering and computer graphics, in *Proceedings of the 11th Congress of the International Ergonomics Association*, pp. 625-627.
- Jindo, T., Hirasago, K. and Nagamachi, M., 1995, Development of a design-support system for office chairs using 3-D graphics. *International Journal of Industrial Ergonomics*, 15(1), 49-62.
- Matsubara, Y. and Nagamachi, M., 1994a, An application of image processing technology in kansei engineering, in *Proceedings of 12th Triennial Congress of the International Ergonomics Association*, pp. (4) 127-131.
- Matsubara, Y. and Nagamachi, M., 1995, Hybrid kansei engineering system and design support. *Symbiosis of Human and Artifact*, 161-166.
- Matsubara, Y., Nagamachi, M. and Jindo, T., 1994b, Kansei engineering as an artificial intelligent system, in *Human Factors in Organizational Design and Management-IV*, pp. 473-478.
- Nagamachi, M., 1986, Image technology and its application. *Japanese Journal of Ergonomics*, 22(6), 316-324.
- Nagamachi, M., 1988a, Image technology based on knowledge engineering and its application to design consultation, in *Proceedings of the 10th Congress of International Ergonomics Association*, pp. 72-74.
- Nagamachi, M., 1988b, Image technology. *Journal of Electronics, Information and Communication Engineers*, 71(3), 245-247.
- Nagamachi, M., 1988c, Assessment of human feeling and image technology. *Journal of Japanese Society of Mechanical Engineers*, 91(838), 955-961.
- Nagamachi, M., 1989a, Kansei engineering approach to automobile. *Journal of the Society of Automotive Engineers of Japan*, 43(1), 94-100.
- Nagamachi, M., 1989b, *Kansei Engineering*. (Kaibundo, Tokyo).
- Nagamachi, M., 1990a, Kansei engineering and development of new product. *Journal of Japanese Industrial Engineering Association*, 41(4B), 66-71.
- Nagamachi, M., 1990b, Procedure of new product development in terms of Kansei Engineering. *Engineers*, 504-1-7.
- Nagamachi, M., 1991a, An image technology expert system and its application to design consultation. *International Journal of Human-Computer Interaction*, 3(3), 267-279.
- Nagamachi, M., (Ed.), 1991b, *Comfort Science*. (Kaibundo, Tokyo).
- Nagamachi, M., 1993a, *A Study of Kansei Merchandise*. (Kaibundo, Tokyo).
- Nagamachi, M., 1993b, Kansei Engineering and its intelligent implication in product development, in *Proceedings of the Second China-Japan International Symposium on Industrial Management*, pp. 539-544.
- Nagamachi, M., 1993, Kansei engineering study on word sound. *Journal of the Acoustic Society of Japan*, 49(9), 638-644.
- Nagamachi, M., 1994a, Kansei engineering: A consumer-oriented technology, in *Human Factors in Organizational Design and Management-IV*, pp. 467-472.
- Nagamachi, M., 1994b, Kansei engineering: An ergonomic technology for a product development, in *Proceedings of 12th Triennial Congress of the International Ergonomics Association*, pp. 120-122.
- Nagamachi, M., 1994c, Kansei engineering: An intelligent system in product development, in *Japan-USA Symposium on Flexible Automation*, pp. 537-540.
- Nagamachi, M., 1994d, Implication of kansei engineering and its application to automotive design consultation, in *Proceedings of the 3rd Pan-Pacific Conference on Occupational Ergonomics*, pp. 171-175.
- Nagamachi, M., 1995a, Kansei Engineering: A new ergonomic consumer-oriented technology for product development. *International Journal of Industrial Ergonomics*, 15(1), 3-12.
- Nagamachi, M., 1995b, *Introduction of Kansei Engineering*. (Japan Standard Association, Tokyo).

- Nagamachi, M., Senuma, I. and Iwashige, R., 1974, A study of image technology. *Japanese Journal of Ergonomics*, 10(2), 121-130.
- Nagamachi, M., Senuma, I. and Iwashige, R., 1977, An analysis of feeling on room atmosphere. *Japanese Journal of Ergonomics*, 13(1), 7-14.
- Nagamachi, M., Ito, K., Fukuba, Y., Tsuji, T. and Kawamoto, H., 1986, Development of interior consultation system in terms of knowledge engineering. *Japanese Journal of Ergonomics*, 22(1), 1-7.
- Nagamachi, M., Ito, K., Fukuba, Y., Tsuji, T., Tabuchi, Y. and Irieda, T., 1985, Image technological study on room lighting. *Japanese Journal of Ergonomics*, 21(5), 265-270.
- Nagamachi, M., Ito, K., Tsuji, T. and Chino, T., 1988, A study of costume design consultation system based on knowledge engineering. *Japanese Journal of Ergonomics*, 24(5), 281-290.
- Nagamachi, M., Kaneda, Y. and Matsushima, K., Automobile and kansei engineering. *Automobile Research*, 11(1), 2-6.
- Osgood, C. E., Suci, G. J. and Tannenbaum, P. H., 1957, *The Measurement of Meaning* (University of Illinois Press, Urbana).
- Tsuchiya, T., Matsubara, Y. and Nagamachi, M., 1995, A study of kansei rule generation using genetic algorithm. *Symbiosis of Human and Artifact*, 191-196.
- Yamamoto, K. 1986, *Kansei Engineering — The Art of Automotive Development at Mazda*. Special Lecture at The University of Michigan, Ann Arbor.

26

Design for Human Assembly (DHA)

26.1	Introduction	26-1
26.2	Product Design for Automation Using Boothroyd's Principles.....	26-2
26.3	MTM Analysis of an Assembly Process	26-3
26.4	Human Factors Principles in Design for Assembly.....	26-7
26.5	Minimize Perception Time.....	26-7
	Visible Parts • Visual Discrimination	
26.6	Minimize Decision Time.....	26-9
	Ease of Formation of a Mental Model • Reduce Choice Reaction Time • Spatial Compatibility • Visual, Auditory, and Tactile Feedback	
26.7	Minimize Manipulation Time	26-11
	Ease of Manipulation • Use Parts That Are Easy to Grip and Don't Tangle • Don't Use Small Parts, such as Washers • Design the Process to Enhance Grasping • Avoid Parts That Nest or Tangle • Consider the Physical Integrity of the Parts • Use Fasteners That Are Easy to Assemble • Use Physical Constraints and Affordances to Simplify Assembly • Reduce Tolerances in Part Mating • Transfer of Training	
26.8	Discussion.....	26-15

Martin G. Helander

Linköping Institute of Technology

Bengt Å. Willén

Linköping Institute of Technology

26.1 Introduction

Ergonomics professionals working for manufacturing companies have in the past specialized in two areas: design of industrial workstations and design of products to improve functionality and usability. In this chapter we are proposing a new field of activity: the study of effects of product design on the type of jobs created in assembly of the product. The basic concept is that through product design, jobs are created in manufacturing. It is then important to design products so they are easy to assemble. In most manufacturing companies there is a choice of using manual labor and automated processes. One must then distribute the manufacturing tasks in an optimal way. This task allocation must be productive for the company, and it must create satisfying jobs for the employees.

Design for Automation (DFA) became of great interest in the early 1980s when robots were first being used for assembly (Boothroyd and Dewhurst, 1982). There was a realization that robots can handle only fairly simple assembly tasks: those that do not require great precision in movement and are also easy to program. In order to enhance the utility of robots, it became necessary to redesign products so they were

easy to assemble. More complicated assembly tasks — tasks that were left over — had to be done manually, which often created monotonous or machine-paced tasks for the employees.

It turned out that DFA guidelines, which were then intended to simplify automatic assembly, also simplified manual assembly. In one study a product was redesigned for automation, but it became so easy to assemble the product manually, that automation did not pay off (Helander and Domas, 1986). It may seem ironic that only the introduction of robots and consideration of their requirements in manufacturing made us reflect on human requirements. One main structural problem in manufacturing is that the primary responsibility of engineers and designers is technology, and there is not an equally detailed analysis of human labor. In the future, however, as the critical trade-offs between machine labor and manual labor are recognized, engineers must take a broader view and consider task allocation between humans and machines — who shall do what.

A narrow focus on automation and technology does not bring about either productivity or job satisfaction. Unfortunately, automation is what engineers take an interest in — modeling and planning of human work is not a priority. To optimize systems performance, engineers need to understand and consider all subsystems including human work capabilities and principles for task allocation.

This chapter will provide an overview of guidelines that may be used in product design to simplify automated assembly as well as manual assembly. The information is presented under three headings: (1) Boothroyd's method for redesign of products, (2) use of predetermined time systems to diagnose product design, and (3) human factors design principles applied to product design.

26.2 Product Design for Automation Using Boothroyd's Principles

The design principles formulated by Boothroyd and Dewhurst (Boothroyd and Dewhurst, 1982, Boothroyd, Dewhurst, and Knight, 1994) have been extremely influential in industry. Several companies, including Hitachi, Black & Decker, General Electric, General Motors, IBM, and Xerox have used these principles to develop corporate guidelines (Gager, 1986; Holbrook and Sackett, 1988).

In Boothroyd's technique an existing product is disassembled (Boothroyd, Dewhurst, and Knight, 1994). The necessity of each part is then analyzed. First one must decide if a part is necessary for assembly or disassembly. A part may be eliminated or integrated with another part if:

1. There is no relative motion between the two parts.
2. The materials of the two mating parts do not have to be different.

For each part the assembly time is measured. Boothroyd made the assumption that an "ideal" assembly time for a part is three seconds. This is reasonable for a part that is easy to handle and insert. A measure of the manual assembly design efficiency E_m is then obtained from the following equation:

$$E_m = \frac{3N_m}{T_m}, \quad (1)$$

where N_m = minimum number of parts, and T_m = total assembly time.

If $E_m < 1$ then the design is inefficient, and if $E_m > 1$ the design is efficient. An example of this methodology is given in Figures 26.1a and 26.1b, and Tables 26.1a and 26.1b.

The value of E_m is not always conclusive. Complex electromechanical products that require extensive wiring tend to have low design efficiencies, even when well designed. On the other hand, simple products with few parts can have a high design efficiency, due to their simplicity rather than their DFA virtues. In their handbook, Boothroyd et al. (1994) provided many examples of successful redesigns where productivity gains of 200 to 300% were obtained.

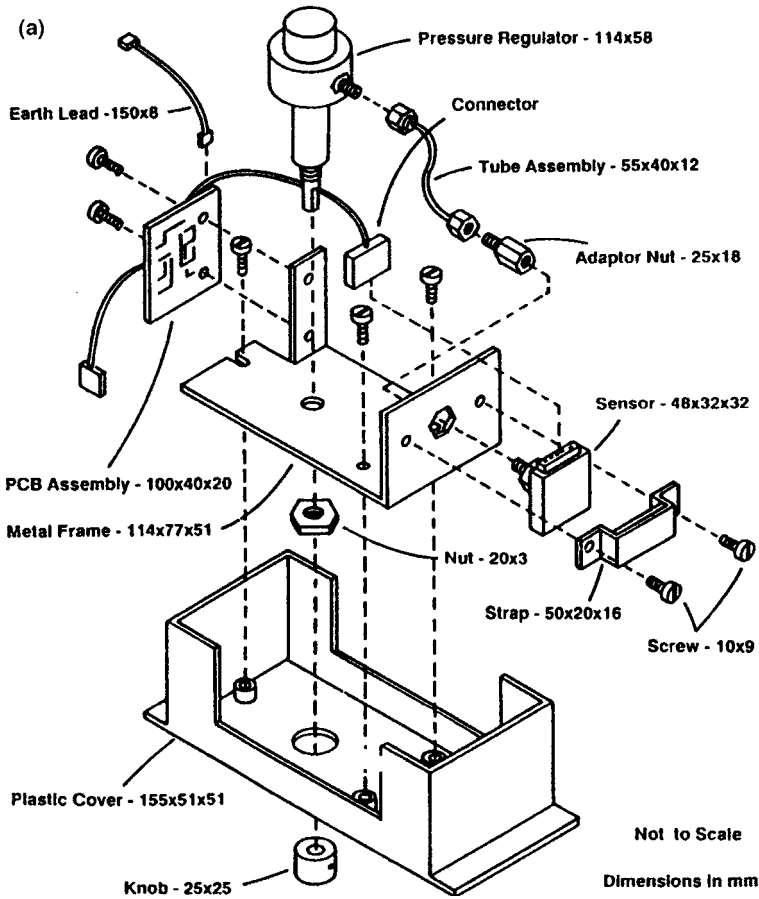

FIGURE 26.1a Example of product redesign for ease of assembly. The old design of the controller had 19 parts. The calculated assembly times are given in Table 26.1a. (From Boothroyd, G., Dewhurst, P. and Knight, W. 1994. *Product Design for Manufacture and Assembly*, Marcel Dekker, New York, NY. With permission.)

26.3 MTM Analysis of an Assembly Process

Boothroyd's technique is useful for redesign of existing products, but is difficult to use for conceptual design of new products. Predetermined time and motion studies (PTMS) can be used to suggest what types of parts should not be used and how parts as well as the assembly process can be redesigned to reduce assembly time. As a basis for our analysis below we use Motion Time Measurement (MTM) (e.g., Konz, 1990). In MTM and other PTMS methods the time for manual assembly is from tables which list the manual assembly for a variety of different cases. These times are based on extensive studies of operators performing assembly in the factory environment.

Assembly time depends not only on how the parts of a product are designed, but also on how they are stored and presented to the operator, and how they are moved to the point of assembly. In MTM, an assembly is broken down into several elemental tasks including: reach, grasp (pickup and select), move, position part, and insert. MTM specifies the amount of time it takes for a trained worker to do each of these elemental tasks. However, the assembly time depends on how the product is designed. Table 26.2 illustrates time savings for a "best design case" as compared to a less efficient design. For example, reaching to a fixed location is the "best case" and takes about 30% less time than reaching to

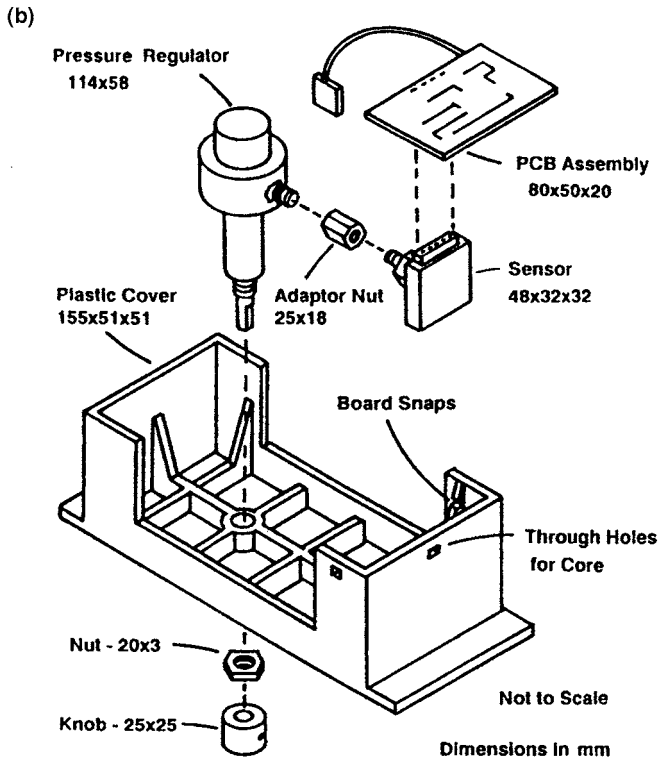

FIGURE 26.1b The new design of the controller had only 7 parts. The calculated assembly times are given in Table 26.1b. (From Boothroyd, G., Dewhurst, P. and Knight, W. 1994. *Product Design for Manufacture and Assembly*, Marcel Dekker, New York, NY. With permission.)

a variable location or to small and jumbled parts. “Grasping” of easily picked up parts is 75% faster than parts that are not easily grasped. Hence, the design engineer should design parts that are easily reached and easily grasped. This can be done, for example, by using large parts rather than small parts.

The parts should be presented at a fixed location. This can be accomplished, for example, by using part feeders. Much research has been performed to develop part feeders for robots and automation (Boothroyd, 1982). They can also be used for manual assembly. A cost-benefit calculation can easily determine whether a parts feeder for manual assembly is cost-efficient. One can simply calculate the savings in time and money for the assembly and compare to the cost for a parts feeder. The information in Table 26.2 can be used for this calculation.

Following the “pick-up,” the part has to be transported and positioned for the final insertion step. Table 26.2 illustrates that moving a part against a stop (Case A) requires about 15% less time than when a part is moved to a location without a stop (Case B). In the latter case the absence of tactile feedback requires greater manual control. Ironically, most products are assembled as in Case B. One objective of good design must therefore be to incorporate stops which provide tactile feedback (Furtado, 1990).

In MTM the parts insertion or mating is described using a position element composed of three complex motions; align, orient, and engage. “Align” is the time required to line up the insertion axes of the two parts, like a pen into a cap. “Orient” describes the basic motions required to geometrically match the cross sections of the two parts, like a key into a lock. “Engage” consists of motions required to insert a part. Alignment is effected by asymmetry of the part, and Table 26.2 exemplifies a 20% time savings for symmetrical parts.

TABLE 26.1a Worksheet for Design for Manual Assembly; the Old Design Had 19 Parts and Required 227.4 s for Assembly

Part. Sub. or PCB assembly or Operation No.	No. of items RP	Handling time per item (s) TH	Insertion time per item (s) TI	Total oper'n cost — cents TA×OP TA	Total oper'n time RP×(TH+TI) CA	Minimal No. parts NM	Operator rate OP: 0.83 cents/s
1. Pressure regulator	1	1.95	1.5	3.5	2.9	1	place in fixture
2. Metal frame	1	1.95	5.5	7.4	6.2	1	add
3. Nut	1	1.13	8.0	9.1	7.6	0	add & screw fasten
4. Reorientation	1	—	9.0	9.0	7.5	—	reorient & adjust
5. Sensor	1	1.95	6.5	8.4	7.0	1	add
6. Strap	1	1.80	6.5	8.3	6.9	0	add & hold down
7. Screw	2	1.80	8.0	19.6	16.3	0	add & screw fasten
8. Apply tape	1	—	12.0	12.0	10.0	—	special operation
9. Adaptor nut	1	1.50	10.5	12.0	10.0	0	add & screw fasten
10. Tube assembly	1	3.00	4.0	7.0	5.8	0	add & screw fasten
11. Screw fastening	1	—	5.0	5.0	4.2	—	standard operation
12. PCB assembly	1	5.60	6.5	12.1	10.0	1	add & hold down
13. Screw	2	1.80	8.0	19.6	16.3	0	add & screw fasten
14. Connector	1	1.95	5.0	6.9	5.8	0	add & snap fit
15. Earth lead	1	5.60	5.0	10.6	8.8	0	add & snap fit
16. Reorientation	1	—	9.0	9.0	7.5	—	reorient & adjust
17. Knob assembly	1	1.95	6.5	8.4	7.0	1	add & screw fasten
18. Screw fastening	1	—	5.0	5.0	4.2	—	standard operation
19. Plastic cover	1	1.95	6.5	8.4	7.0	0	add & hold down
20. Reorientation	1	—	9.0	9.0	7.5	—	reorient & adjust
21. Screw fastening	3	1.80	10.5	36.9	h30.8	0	add & screw fasten
				T_m :	C_m :	N_m :	Design efficiency:
				227.4s	\$1.90	5	$\frac{3N_m}{T_m} = 0.07$

Adapted from Boothroyd, G., Dewhurst, P. and Knight, W. 1994. *Product Design for Manufacture and Assembly*, Marcel Dekker, New York, NY.

TABLE 26.1b The Improved Design Had Only 7 Parts with an Estimated Assembly Time of 83.8 s

Part. Sub. or PCB assembly or Operation No.	No. of items RP	Handling time per item (s) TH	Insertion time per item (s) TI	Total oper'n cost — cents TA×OP TA	Total oper'n time RP×(TH+TI) CA	Minimal No. parts NM	Operator rate OP: 0.83 cents/s
1 Pressure regulator	1	1.95	1.5	3.5	2.9	1	place in fixture
2 Plastic cover	1	1.95	5.5	7.4	6.2	1	add & hold down
3 Nut	1	1.13	8.0	9.1	7.6	0	add & screw fasten
4 Knob assembly	1	1.95	6.5	8.4	7.0	1	add & screw fasten
5 Screw fastening	1	—	5.0	5.0	4.2	—	standard operation
6 Reorientation	1	—	9.0	9.0	7.5	—	reorient & adjust
7 Apply tape	1	—	12.0	12.0	10.0	—	special operation
8 Adaptor nut	1	1.50	10.5	12.0	10.0	0	add & screw fasten
9 Sensor	1	1.95	8.0	9.9	8.3	1	add & screw fasten
10 PCB assembly	1	5.60	2.0	7.6	6.3	1	add & snap fit
				T_m :	C_m :	N_m :	Design efficiency:
				83.8s	\$0.70	5	$\frac{3N_m}{T_m} = 0.18$

Adapted from Boothroyd, G., Dewhurst, P. and Knight, W. 1994. *Product Design for Manufacture and Assembly*, Marcel Dekker, New York, NY.

TABLE 26.2 Examples of Time Savings Obtained with the “Best Case” as Compared to Less Efficient Alternatives. The Cases and Codes Used in MTM for Classification Are also Mentioned

	Best Case	Comparison	Time Increase from Best Case to Comparison
Reach	To fixed location (case A)	To variable location (case B) To small or jumbled objects (case C)	30% 40%
Grasp			
1. Pickup	Easily grasped (case 1A)	Object on flat surface (case 1B) Small object, 1/2 inc. (case 1C2)	75% 400%
2. Select (For jumbled objects only)	Large jumbled objects (case 4A)	Object smaller than 1×1×1 in. (case 4B, 4C)	50%
Move	Against a stop or to other hand (case A)	To exact location without a stop or physical barrier (case C)	15%
Position Part			
1. Symmetrical part	Symmetrical, e.g., round peg in round hole (code S)	Semisymmetrical, 45 degree turn typical (code SS) Nonsymmetrical, 75 degree turn typical (code NS)	20% 30%
2. Depth of insertion	No depth	4" insertion	100%
3. Pressure to fit	Gravity, no pressure (code 1)	Light Pressure (code 2) Heavy Pressure (code 3)	210% 500%
Disengage (two parts)			
1. Class of fit	Loose	Tight	500%
2. Ease of handling	Easy	Difficult	40%

26.4 Human Factors Principles in Design for Assembly

PTMS does not consider the time required for human information processing and decision making. Yet, even in simple, repetitive manual tasks, operators make decisions, and this takes time (Fish, 1993). Since the overall goal in DFA is to reduce the time for the assembly, one has to consider both mental and manual aspects of the assembly task. For the human operator, there are three sequential time components in information processing and task execution: time required for (1) perception, (2) decision making, and (3) manipulation. Each of these can be minimized by thoughtful product design, and for each of the three time components there are different design methods to consider in product design. Table 26.3 lists the three time components in the “Why” column, their implications in terms of behavioral principles in the “What” column, and the types of measures that may be implemented in the “How” column. Table 26.3 hence establishes three levels of abstraction going from the overall purpose to the implementation of human factors principles applicable to Design for Human Assembly (DHA).

26.5 Minimize Perception Time

Visible Parts

Visibility is important in assembly. Everything that is used in a manufacturing task should be fully visible. Hidden or invisible parts or tools are difficult to refer to; they cannot be pointed at. They become abstract and difficult to think of. The design of the product should be such that the assembly can be performed with full visibility of parts and tools, see Figure 26.2. Hidden or invisible parts are also difficult to operate on and they are sometimes forgotten.

TABLE 26.3 Human Factors Principles in DHA

Why	What	How
Minimize perception time	Visible parts Visual discrimination Tactile discrimination	Nothing hidden Size, color Texture, size
Minimize decision time	Ease the formation of a mental mode Reduce choice reaction time Spatial compatibility Visual, auditory, and tactile feedback	Visible parts Minimize number of parts Collocation of associated items Assembly looks different, auditory and tactile snaps
Minimize manipulation time	Ease of manipulation Physical affordances and constraints Design for transfer of training	Fixture to hold parts, parts that are easy to grip and don't tangle, fasteners that are easy to use Self-locating parts, increase tolerances New product similar to old

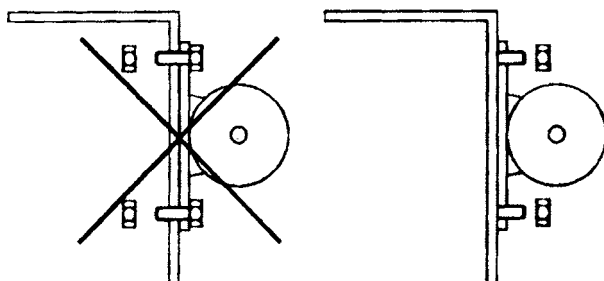
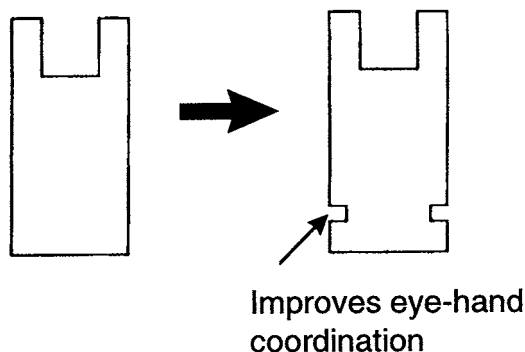
**FIGURE 26.2** Avoid designs that lead to hidden assembly. From Willkrans, R. 1995. *Design for Easy Assembly*, IVF, publ. 95825, Gothenburg, Sweden. With permission.)**FIGURE 26.3** Exaggerated asymmetry may enhance stimulus–response compatibility.

Visual Discrimination

Parts may be perceptually organized by using different shapes, sizes, and colors. For example, color coding of parts may be used to form families of parts, that is, parts which belong together in a subassembly. Color coding will also enhance stimulus–response compatibility in assembly and results in reduced reaction time and better eye–hand coordination.

If asymmetric parts are used (see Figure 26.3), it may be advantageous to exaggerate the asymmetry to improve visual cues (Chhabra and Ahluwalia, 1990).

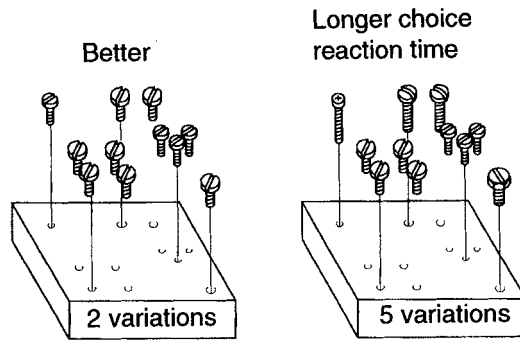

FIGURE 26.4 Minimize the various types and sizes of screws.

Tactile Discrimination

Parts shall be designed so that they can be discriminated by touch alone. This can be accomplished by using parts of different size, texture, and so forth.

26.6 Minimize Decision Time

Ease of Formation of a Mental Model

Workers develop mental models of the task they are performing; they think of an assembly in a certain way. Mental models are important since they help the worker to organize the execution of a task. However, things that are difficult to see become abstract and it is then difficult to form a mental model. Task visibility is important and helps the creation of a mental model (Prabhu, Helander, and Shalin, 1995). The concept of mental models has been used extensively in human–computer interaction. Software programmers have a different mental model than users of the same software. Therefore, programmers fail to consider the needs of the user. Similarly, in manufacturing the product designer may fail to consider the operators' mental model. In fact, there are many different tasks in manufacturing with different mental models (Baggett and Ehrenfeucht, 1991). A person assembling a product would have a different mental model than a person responsible for quality control of the same product. They look for different things and they do different things, and the priorities are different. This observation is contrary to the notion that assembly operators should exercise their own quality control; it may be difficult to change mindset (Shalin, Prabhu and Helander, 1996).

Reduce Choice Reaction Time

Minimize the Number of Components and Parts

An example of how to reduce the number of components and parts is to minimize the various types and sizes of screws. Fewer parts reduce the number of parts bins, which in turn reduces the operators' choice reaction time (see Figure 26.4). It will also save space. In addition, fewer parts will reduce the number of hand tools, which in turn decreases choice reaction time and space requirements.

Use Symmetrical Parts Because They Are Easy to Orient

The use of symmetrical parts reduces information processing time, since the operator does not have to decide whether to turn the part around. It also reduces manual handling time (see Figure 26.5).

Integrate or Combine Parts

Integrate or combine parts, since they simplify the operators' mental model, reduce choice reaction time, and often take less time to assemble. In some cases an entire subassembly can be replaced by a single

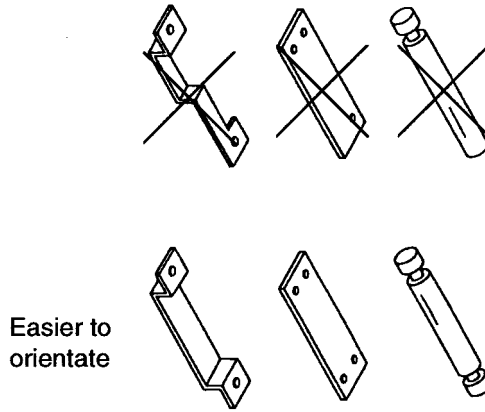

FIGURE 26.5 Use parts that are easy to orient, such as symmetrical parts.

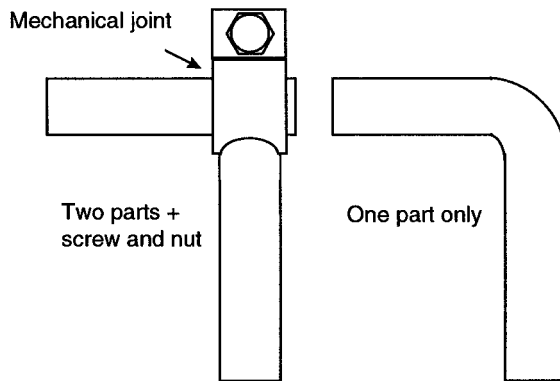

FIGURE 26.6 Integrate or combine parts.

part (compare modular design in electronics). Integrated parts may be difficult to handle manually, but overall they are efficient, since they reduce the number of operations (Figure 26.6).

Holbrook and Sackett (1988) noted that it is difficult to combine parts if:

- Parts move relative to each other
- Parts are required to be of different materials
- Parts must be separate for maintenance and service reasons
- Parts are necessary to enable the assembly of remaining parts

Combined parts can often be fabricated using plastic injection moulding. Another advantage with plastic parts is that they can easily be provided with chamfers, notches, and guides which are helpful in assembly. Metal parts can also be moulded or mounted into plastic parts. The elastic property of thermoplastics, (e.g., nylon) can be utilized to form snap joints, integral springs, and integral hinges. Thermoplastics can also be utilized to straighten other parts and to eliminate clearances.

Spatial Compatibility

Spatial compatibility has to do with the spatial layout of a workstation. Part bins can be located in sequential order so the operator can pick parts from left to right in the same order as used in the assembly.

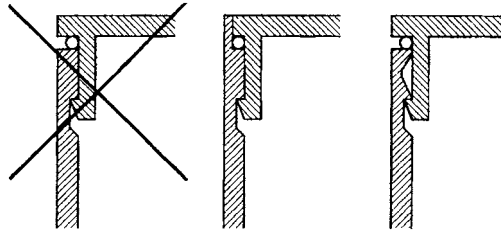

FIGURE 26.7 Integral fasteners and clips should be designed so that the operator can see, feel, or hear that the assembly has succeeded. (From Willkrans, R. 1995. *Design for Easy Assembly*, IVF, publ. 95825, Gothenburg, Sweden. With permission.)

Part bins can also be arranged so that their location mimics the product design. This could, for example, be used with components that are inserted in an electronic board. The best arrangement depends on the product design and the number of parts used. Obviously, product design should consider spatial compatibility (Helander and Waris, 1993).

One should also consider the locations of hand tools and controls. Typically, items that belong together in task execution should be physically close.

Visual, Auditory, and Tactile Feedback

When a task has been completed, there should be visual feedback — in other words, something should look different. Sometimes in automobile assembly a piece of tape is put on top of an assembly to indicate it is finished.

An example of tactile feedback is the use of physical stop barriers. When a part is moved against a stop there is a sensation in the fingers — tactile feedback which indicates that the task was completed. Auditory feedback is helpful not only with parts but also for hand tools and controls and for hand tools operating on parts. In this case a sound is produced that indicates task completion. For example, the clicking sound of a switch or the ricketing noise of a hydraulic screwdriver indicates that the task has been completed (see also Figure 26.7).

26.7 Minimize Manipulation Time

In this section we provide examples of product design features that simplify assembly by ease of manipulation. Many of them are used for automation and have been published in DFA guidelines for DFA. They, however, apply equally well to manual assembly (Helander and Nagamachi, 1992).

Ease of Manipulation

Use a base part as product foundation and fixture. Design the product with a base part as foundation and fixture for other parts. It should be possible to assemble the other parts from one direction, preferably from above (see Figure 26.8). It is also advantageous to use fasteners which are inserted from one direction, either from the front or from above. The base part should also serve as a fixture. If this arrangement is not feasible, pins can be used so the base part can be easily positioned on a fixture as in Figure 26.8. If this is not possible, a specially designed fixture is used. To make the product easy to transport, it should have a flat bottom and a simple shape.

Use Parts That Are Easy to Grip and Don't Tangle

Improve parts handling by using parts that are easy to grip (see Figure 26.9).

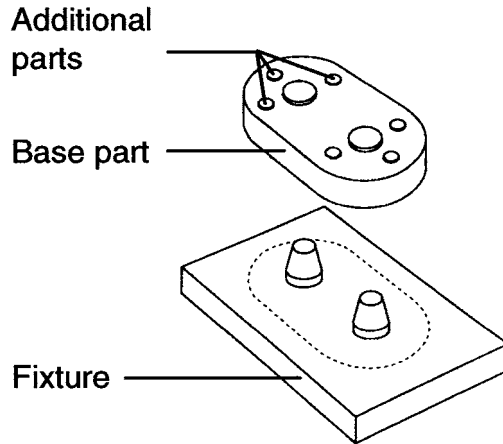

FIGURE 26.8 Provide a simple and reliable fixture for the base part. If possible, the base part should also serve as a fixture.

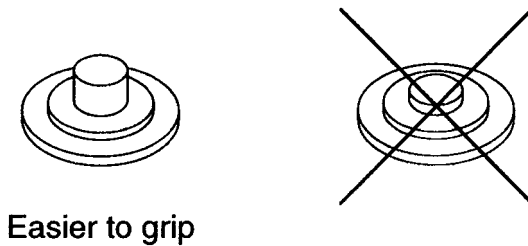

FIGURE 26.9 Improve parts handling by making parts easy to grip.

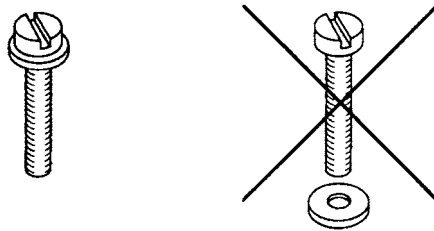

FIGURE 26.10 Do not use small parts that are difficult to handle, such as washers.

Don't Use Small Parts, such as Washers

Avoid using separate washers which increases manual handling time. This requirement, which is a necessity in robotics assembly, simplifies manual assembly as well (see Figure 26.10). The use of washers increases manual handling time. It may also make it necessary for the operator to use pinch grips, which may increase the risk for cumulative trauma disorder.

Design the Process to Enhance Grasping

Luczak (1993) presented several methods which simplify the grasping of a part to be assembled (see Figure 26.11).

This is a complementary approach. The parts are not redesigned to be easier to grasp, rather the process (of grasping) is redesigned. Process design is typically more abstract than product design and

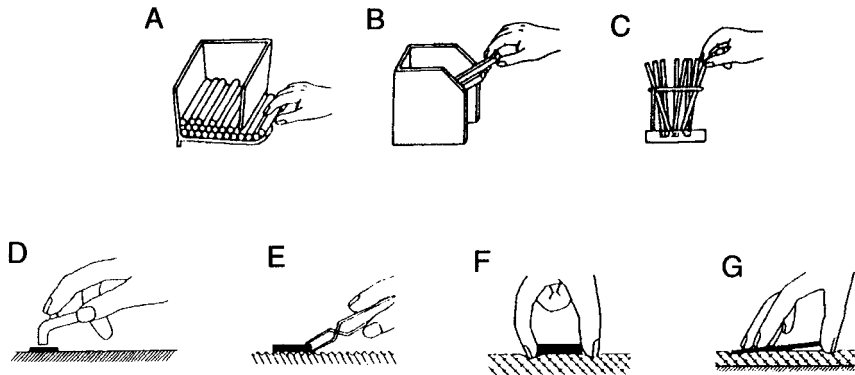

FIGURE 26.11 Gripping aids for an assembly workstation. (A) Self-feeding container. (B) Container with inclined opening. (C) A ring holder with smaller bottom diameter. (D) Use of vacuum gripper. (E) Tweezers or tongs used against a rippled table surface. (F and G) Gripping against a soft surface.

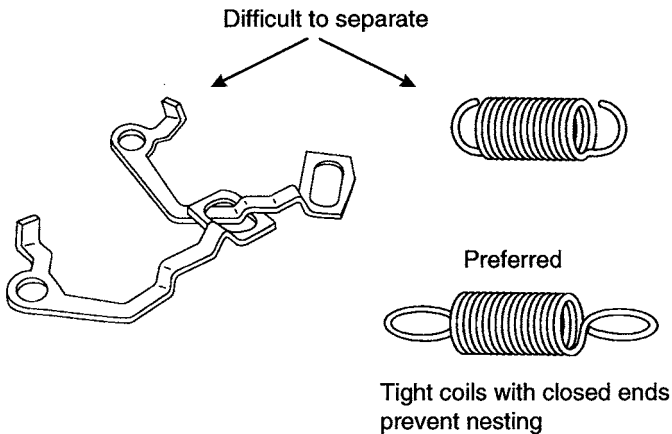

FIGURE 26.12 Avoid parts that nest or tangle.

therefore more difficult to think of and to suggest innovative solutions. In Figure 26.11 the process is redesigned for the purpose of improving the interactivity of products and processes so that manual assembly is made easier.

Avoid using flexible parts, such as wires, cables, and belts, because they are difficult to handle. Sometimes components can be plugged together in order to eliminate the use of connecting wires.

Avoid Parts that Nest or Tangle

Close open ends and make part dimensions large enough to prevent tangling. For example, use springs with closed ends rather than open ends (see Figure 26.12).

Consider the Physical Integrity of the Parts

Parts that are weak or easily bent are difficult to assemble (see Figure 26.13). These parts often cause extra work in quality control, visual inspection, and replacement. Grossmith (1992) noted that many microscope inspection tasks can be avoided if product designers choose materials that are less likely to chip and crack.

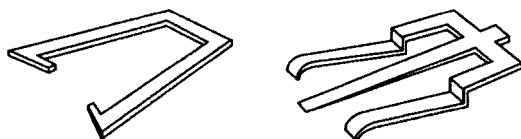

FIGURE 26.13 Avoid parts that are easily bent or parts that crack or chip.

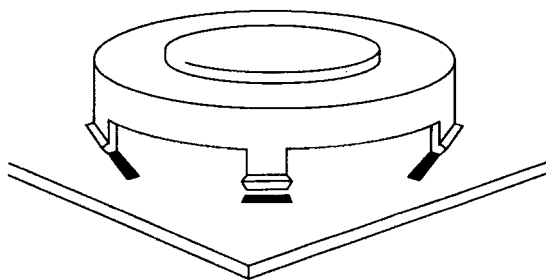

FIGURE 26.14 Use snap and insert assembly.

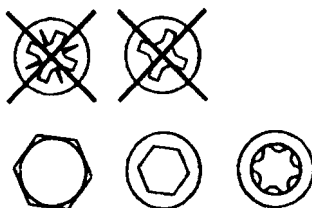

FIGURE 26.15 Use screws which do not create lifting forces on the tool. (From Willkrans, R. 1995. *Design for Easy Assembly*, IVF, publ. 95825, Gothenburg, Sweden. With permission.)

Use Fasteners That Are Easy to Assemble

If practical, avoid fasteners by using snap-and-insert assembly. Design integral fasteners and clips into parts so that no screws are required as in Figure 26.14.

If screws are used, it is better to use screws that do not create lifting forces on the tool as in Figure 26.15. Thereby the tool will not so easily disengage from the screw. Musculo-skeletal discomfort is also reduced (Cederqvist and Lindberg, 1993).

Use Physical Constraints and Affordances to Simplify Assembly.

Use self-locating parts, such as parts with chamfers, notches, and guides for self-location to simplify assembly (see Figure 26.16). The use of chamfers, for example, reduces the amount of manual precision necessary to insert the part. This is obvious from Fitts's law, since a larger target area (chamfer) reduces the time for manual handling (Fitts and Posner, 1973).

Reduce Tolerances in Part Mating

Part mating becomes easier if tolerances are reduced. For example, Figure 26.17 illustrates how a slotted hole may be used to simplify positioning and relax accuracy requirements.

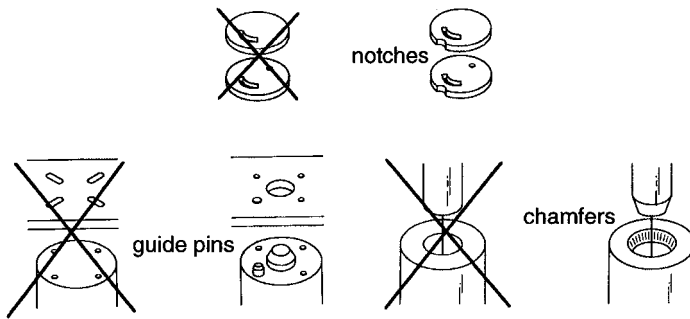

FIGURE 26.16 Facilitate assembly by using self-locating parts.

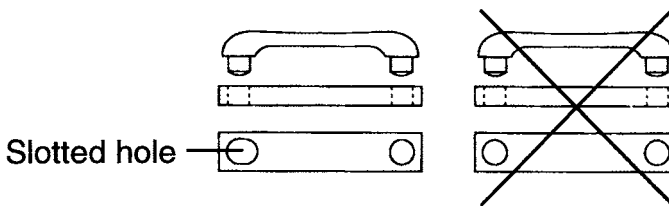

FIGURE 26.17 Reduce tolerances in part mating.

Transfer of Training

Transfer of training applies when a new product has only small modifications compared to the old product. A worker can then apply his previously acquired skills to the new product. Differences in product design and workstation layout, on the other hand, may create confusion, and assembly times can increase drastically. Product designers have a responsibility here, so they try to make the assembly of new products similar to the assembly of previous products (Shalin, Prabhu and Helander, 1996).

26.8 Discussion

This paper has presented three different principles, which can be used for design for human assembly: Boothroyd's principles, PTMS, and DHA. Boothroyd's work, the principles for design for automation (DFA), also have implications for design for human assembly (DHA). We noted in the introduction that principles for human assembly were inspired by the introduction of robots, when it became obvious that product design can be changed to fit both the requirements of automation and human assembly. The present interest in concurrent engineering makes it necessary to consider many criteria in design, such as the trade-offs between automation and human labor. In small batch manufacturing, automation will be less important and much assembly will be performed by manual labor. Yet there are manufacturing processes where automation is necessary, and for other tasks human labor is essential. These are important arguments for design engineers to comprehend and utilize principles for DHA. Yet engineers may not take an interest. The education of engineers emphasizes hardware and software design of systems, which are considered high priorities. To optimize systems performance it will be necessary for engineers to include principles of human factors engineering.

One traditional engineering tool which is informative for product design is the use of PTMS to model the time elements in assembly for alternative product design. We are not interested in the assessment of the performance of individual workers, which is what PTMS was created for, but rather as a modeling tool in engineering design. PTMS does not need an existing design for analysis, whereas DFA analyzes an existing design as a point of departure for a new design. With DFA principles, one can make more

concrete suggestions than with PTMS. This is to be expected with iterative design. PTMS broadens the scope compared to Boothroyd's principles, since PTMS will also consider workstation design parameters which affect the assembly, for example, how the layout of part bins affects the time for reaching, grasping, and moving parts.

DHA offers a much more detailed analysis, since we consider the three phases in the human information processing chain: perception, decision making, and motor response (manipulation). It is then possible to understand the requirements and capabilities of the human operator for each of the three steps, and propose human principles for product design to reduce assembly time. Visibility and visual and tactile discrimination are important to enhance perception. Visibility is of course a requirement for perception, but it is also important for decision making, since it is easier to create a mental model of an assembly and support memory. Likewise, several of the other principles in Table 26.3 have dual use; a reduction in the number of parts will reduce the time for decision making as well as assembly time. Feedback of any kind is essential to decide if the task has been finished, but feedback must, of course, first be perceived. The use of large parts will enhance visibility and facilitate assembly, and so forth.

By using the human information processing chain as a frame of reference, we can readily interpret the human requirements in DHA. The levels of abstraction in Table 26.3 can be used to derive principles, which can then be conceptualized and better interpreted in the light of our knowledge of human information processing.

Acknowledgment

Both authors assume equal responsibility for this text.

References

- Baggett, P. and Ehrenfeucht, A. 1991. Building physical and mental models in assembly tasks, *International Journal of Industrial Ergonomics*. 7:217-228.
- Boothroyd, G. 1982. *Design for Assembly Handbook*, Department of Mechanical Engineering, University of Massachusetts, Amherst, MA.
- Boothroyd, G., Dewhurst, P. and Knight, W. 1994. *Product Design for Manufacture and Assembly*, Marcel Dekker, New York, NY.
- Cederqvist, T. and Lindberg, M. 1993. Screwdrivers and their use from a Swedish construction industry perspective. *Applied Ergonomics*. 24(3):148-157.
- Chhabra, S.L. and Ahluwalia, R.S. 1990. Rules and guidelines for ease of assembly. *Proceedings of the International Ergonomics Association Conference on Human Factors in Design for Manufacturability and Process Planning*, p. 93-99. Human Factors and Ergonomics Society, Santa Monica, CA.
- Fish, L. 1993. *A Cognitive Model for Assembly*. Dissertation. State University of New York at Buffalo, Department of Industrial Engineering, Buffalo, NY.
- Fitts, P.M. and Posner, M. 1973. *Human Performance*, Prentice-Hall, Englewood Cliffs, NJ.
- Furtado, D. 1990. Principles of design for assembly. *Proceedings of the International Ergonomics Association Conference on Human Factors in Design for Manufacturability and Process Planning*, p. 147-152. Human Factors and Ergonomics Society, Santa Monica, CA.
- Gager, R. 1986 Design for productivity saves millions, *Appliance Manufacturer*, Jan. 46-51.
- Genaidy, A.M., Duggai, J.S. and Mital, A. 1990. A comparison of robot and human performances for simple assembly tasks. *International Journal of Industrial Ergonomics*, 5:73-81
- Grossmith, E.J. 1992. Product design considerations for the reduction of ergonomically related manufacturing costs, in *Design for Manufacturability. A Systems Approach to Concurrent Engineering and Ergonomics*, Eds. M.G. Helander and M. Nagamachi, Taylor & Francis, London.
- Helander, M.G. and Domas, K. 1986. Task allocation between humans and robots in manufacturing. *Material Flow*, 3:175-185.

- Helander, M.G. and Nagamachi, M. 1992. *Design for Manufacturability. A Systems Approach to Concurrent Engineering and Ergonomics*, Taylor & Francis, London.
- Helander, M.G. and Waris, J. 1993. Effect of spatial compatibility in manual assembly performance, in *Ergonomics of Manual Work*, Eds. W.S. Marras, W. Karwowski, J.L. Smith and L. Pacholski, p. 421-424, Taylor & Francis, London
- Holbrook, A.E.H. and Sackett, P.J. 1988. Design for assembly guidelines for product design. *Assembly Automation*. 8:202-211.
- Konz, S. 1990. Work Design: *Industrial Ergonomics*, Publishing Horizons, Worthington, OH.
- Luczak, H. 1993, *Arbeitswissenschaft*, Springer-Verlag, Berlin.
- Mital, A. 1991 Economics of flexible assembly automation: Influence of production and market factors, in *Economic Aspects of Advanced Production and Manufacturing Systems*, Eds. H.R. Parsei and A. Mital, Chapman & Hall, London.
- Prabhu, G.V., Helander, M.G. and Shalin, V. 1995. Cognitive implications of product structure on manual assembly performance. *International Journal of Human Factors in Manufacturing*. 5:149-161.
- Shalin, V., Prabhu, G.V. and Helander, M.G. 1996. A cognitive perspective on manual assembly. *Ergonomics*. 39:107-126.

27

Human Factors in Agile Manufacturing

27.1	Introduction	27-1
27.2	Product Specification and Automated Design.....	27-2
27.3	Product Data Management.....	27-3
27.4	Virtual Prototype Testing	27-4
27.5	Visualization	27-5
27.6	Communications	27-5
27.7	Differences between Agile and Traditional Enterprises.....	27-5
27.8	Ergonomics of the Agile Shop Floor.....	27-10
	Operator Selection and Training • Procedures • Shift Work • Human–Computer Interfaces • Safety Procedures • Shop Floor Culture	
27.9	Conclusion.....	27-12

Chris Forsythe

Sandia National Laboratories

Eric Grose

Sandia National Laboratories

27.1 Introduction

In *21st Century Manufacturing Enterprise Strategy*, Nagel and Dove¹ introduced “Agile Manufacturing” as a production paradigm that would replace mass production as the dominant industry paradigm around the globe. Since this original postulation, government and industry have championed agility, as agile manufacturing has come to be known, as the solution for reinvigorating U.S. industrial competitiveness, and substantial efforts have been devoted to developing the requisite technologies and experimenting with various implementations of agility concepts.²⁻⁵ Although it may have different manifestations across various industries, agility is commonly characterized by each of the following:

- Cycle time reduction for new product development
- Flexible and continually evolving manufacturing base
- Focus on product customization
- Reliance on information-driven manufacturing⁶
- Virtual co-location achieved through communications technologies
- Opportunistic partnering to fill market demands

In the migration from existing product development and production processes, and accompanying business practices, the greatest changes will occur with the human interfaces that exist throughout an enterprise. These interfaces will often describe the points of interaction between people and technology, but equally, if not more often, the human interfaces will be between different people, within and across enterprises, and between people and engineering, production, and businesses practices. The following sections identify human interfaces important to the realization of agility and the application of human factors to these interfaces.

27.2 Product Specification and Automated Design

Central to the concept of agility is the notion of “mass customization,” or providing products that are finely tuned to the individualized requirements of a specific customer.^{1,7} Mass customization, in a greatly simplified substantiation, is not a new concept. Pizza makers have long provided the opportunity for customers to select from alternative sizes and combinations of toppings. In contrast, agility goes well beyond providing a fixed set of alternatives from which the customer may choose, to custom fitting the product to the unique requirements of a given customer. This level of customization is demonstrated by National Bicycle and their capacity to rapidly produce a bicycle custom fit to the body dimensions of a specific customer.⁸ For many products, such as bicycles, specification of a custom product may be a simple process of matching dimensions of the product to those required by the customer. For other products, the relationship between design variations and product interfaces or product performance is considerably more complex. For example, it may be necessary for a product to function as a component of an overall system, interfacing with other components for which chemical, thermal, and other considerations must be accommodated. Similarly, complex interactions may exist between certain design attributes of a given product (e.g., weight reduction to enhance mechanical speed of operation may reduce product robustness). Where product specification goes beyond allowing the customer to choose from a fixed set of alternatives or simple matching of one or more design attributes, such as physical dimensions, designers need an interface that meaningfully represents the range of product variations, and makes the process of specifying new products from the range of variations intuitive and readily accomplished.

The set of design attributes that are varied to meet different customer requirements may be thought of as design parameters.^{5,7} The design parameters that are varied for a given product define a design parameter space within which alternative designs may be represented as points defined by their values on each of the design parameters. Thus, it may be asserted that the process of specifying a given design is really one of selecting a point (design) from within the parameter space. The first step in developing an interface by which a given product (or point design) may be specified is to define the parameter space for that product. For all but the simplest products, definition of a parameter space will require preliminary research and development to determine the range of anticipated customer applications, and identify the relationships between design parameters and performance variables, and the bounds placed on design parameters by the limitations of manufacturing processes.⁷ This preliminary work may also establish relevant cost and schedule relationships.^{5,7} Once defined, the parameter space provides the basis for the product specification interface.

A decision tree offers a simple interface by which designers work their way through a series of decisions, until the complete design specification has been attained. As certain decisions constrain the array of available design options, these constraints may be represented by the number or range of options available at specific points in the tree. A significant drawback of the decision tree concept is that it offers little to aid the recognition and appreciation of design trade-offs. Tweedie et al.⁹ have demonstrated the “Influence Explorer,” an interface that very effectively depicts design trade-offs by maintaining an ongoing graphical representation of design alternatives available, following each design decision. As design trade-offs are encountered, partially or nonoverlapping ranges of available design alternatives are shown. Furthermore, a graphical interface such as the Influence Explorer may be combined with knowledge elicitation techniques (e.g., ELK¹⁰) to assure the proper breadth and depth of information is obtained during product specification.

Once requirements are known, values must be determined for design attributes to define a concept design satisfying customer requirements. For many simple, well-understood products, the process of generating design attributes from customer requirements may be automated. Taking as an example a simple mounting plate, if interface constraints and design attributes such as weight, physical dimensions, and center of gravity are known, and environmental factors such as maximum shock, vibration, and acceleration are specified, an automated routine may be developed whereby design attributes of the mounting plate such as size and thickness, and number, size, and position of connectors are automatically

generated. A spreadsheet offers an effective interface in that the designer need only enter necessary design attributes and, based on these entries, design dimensions may be automatically generated.¹¹ Such routines may be interfaced with Computer-Aided Design (CAD) software to create electronic representations of the part, from which 3-D models may be easily derived.^{5,11}

While automated design routines may greatly streamline the design process, extensive automation of design is rarely practical or desirable.¹² In selecting facets of design for automation, design tasks that are highly detailed and time consuming, yet mundane, are prime candidates for automation.^{5,13,14} Within an agile enterprise, it is preferred that human knowledge and skills be applied to challenging aspects of product development and not wasted on routine, monotonous tasks that often require considerable skill, due to their dependence on proficiency with Computer Aided Design (CAD) software.

27.3 Product Data Management

An agile enterprise must have mechanisms in place to capture corporate knowledge and then, with each new product development, deploy that corporate knowledge to its maximum benefit. This reliance on corporate knowledge makes it essential that there be an effective interface for locating and retrieving relevant product data. Forsythe and Ashby have demonstrated an interface whereby product archives may be searched on the basis of design attributes.¹⁵ The designer may enter specific values for attributes such as voltage and use relational operators (e.g., >, <, ≤) for other attributes (e.g., minimum operating temperature, maximum sustained vibration). Given the desired combination of design attributes, the product data manager (PDM) searches through archived design files to return all designs with the specified design attributes. Where there are no known designs that meet the search criteria, using engineering judgment, the designer may relax one or more attributes to find those designs that approximate the desired characteristics. Similarly, where there is a failure to comply with precise physical dimensions, copies of design files may be obtained and appropriate modifications made. Where there is a failure to comply with performance attributes, such as environmental requirements, analysis and testing files associated with archived designs may be located and often information contained therein may provide the necessary data to determine how to modify the previous design to meet current requirements. For example, the results of thermal stress analysis may be reviewed to identify weak points in the mechanical assembly that may be redesigned to provide the necessary level of robustness.

Along with design files, and associated analysis and testing data, the PDM also provides associative links to manufacturing data, machine code, and robot assembly code.¹⁵ Manufacturing data may be used to evaluate design tolerances, and machine code and robot assembly code may be reused where no or minimal design changes have been made. Additionally, the PDM allows documentation to be associatively linked to design files, preserving a design history of each new product development effort. Although there exists nearly limitless potential to manage product data as it is generated and reuse that product data during subsequent development, significant trade-offs must be made. In particular, the reusability of product data is proportional to the extent to which meta-data or data attributes are specified. To be maximally reusable, it is necessary to provide rich descriptions of product data using numerous attributes. However, this introduces considerable overhead to the process of entering product data into the PDM, automated capture of attributes considered. Consequently, in designing the PDM interface, it is essential to weigh the value of reusing product data against the overhead incurred in entering product data.

The design of the PDM interface must also accommodate the range of disciplines that must employ the system, and the unique interests, terminology, and work processes of each of these disciplines.¹⁵ While much of the benefit derived from the PDM is attributable to having a single data repository, the need to support a diverse group of users may necessitate the development of customized interfaces for each discipline. For example, whereas the design engineer may need to search product data on the basis of specific design attributes, the test engineer may have little use for this utility, but, instead, may need to search product data on the basis of attributes describing alternative test configurations.

Beyond capturing and enabling the reuse of corporate knowledge, the PDM also accomplishes two additional objectives essential to agility. First, within a fast-paced product development environment,

much of the work of designers, manufacturing and assembly engineers, quality assurance, and others occurs in parallel.⁵ Under these conditions, numerous modes of failure exist, whereby multiple versions of a design can enter into circulation. Through strict control of read/write permissions and check-in/check-out protocols, the PDM introduces a structured process that assures all participants in the product development effort work with the latest version of design files. Second, within an agile production environment, every hour can be precious. Concurrent engineering must permeate all facets of production, since late design changes can have devastating effects on the ability to meet tight schedules. Consequently, it is important that all participants in the production process be kept aware of ongoing changes as they are made, so that there is an opportunity to affect those changes at the earliest possible point. Through automatic notification, all participants in the product development effort are alerted to design changes and provided regular status updates. After making changes to a design file, on returning the file to the PDM, e-mail is automatically sent to participants, alerting them to the changes. Both version control and automatic notification serve valuable functions enabling the tight coordination of parallel efforts by representatives from multiple disciplines; but most important, information currency is assured with minimum overhead and distractions from basic engineering activities.

27.4 Virtual Prototype Testing

During the course of design development, many questions may arise regarding the feasibility or performance of design alternatives. Traditionally, such questions would be addressed by either adopting a conservative, low-risk, but limited design strategy, or conducting time-intensive, often costly physical testing. As a result, design innovation has often been sacrificed for the sake of cost and budget concerns.

Agility incorporates virtual prototype testing, when posed with design decisions for which there may be considerable risks. Virtual prototype testing may take various forms. One example would be engineering analysis codes that using three-dimensional design models, assess characteristics such as static and shock loading, vibration, operational environment, and thermal environment. Dynamic simulations that allow functionality to be evaluated on the basis of 3-D models represent another example. In a further example, stereolithography allows design alternatives to be assessed on the basis of physical representations.

Virtual prototype testing contributes to decision processes by providing a mechanism that enables hypothesis testing. Whereas, traditionally, design has involved an inductive process, whereby design is largely an act of creation and inductive reasoning,¹⁶ and evolves through small gradations, virtual prototyping makes it possible for designers to readily apply deductive processes, generating and testing hypotheses as they seek innovative design solutions. To be effective, certain conditions must be met. First, there needs to be a rapid turnaround. From the time that a design question is posed, an answer must be available within days, if not hours. Given that the primary bottleneck encountered will likely result from the large number of CPU cycles required by some analysis routines and the availability of requisite supercomputing resources, other aspects of the virtual prototyping process must be streamlined. This includes: definition of the analysis, preparation of the analysis, and communication of results. In defining the analysis, concurrent engineering processes should emphasize a close working relationship between designers and engineering analysts, from the earliest design stages. This allows the designer to take advantage of the analyst's expertise to narrow analysis options to those most likely to yield success. Second, since the basic design representation used by the designer will be a CAD model, processes should be in place to minimize or essentially eliminate the often tiresome steps necessary to convert CAD representations into a format suitable for analysis. This may include routines for the translation of CAD representations into 3-D solid models, and from there, the generation of finite element models.⁵ Furthermore, mechanisms may need to be implemented to validate analyses prior to execution so as to avoid lost time and computing resources that may result if parameters are incorrectly defined. Finally, visualization techniques may be employed to aid in the interpretation and communication of virtual prototype testing results.

TABLE 27.1 Differences between Communications in an Agile and a Traditional Enterprise

Traditional Enterprise	Agile Enterprise
<ul style="list-style-type: none"> • Geographical Co-Location • Solitary Work • Sequential Flow of Information • Time is Negotiable • Standardization of Technology • Static Product Artifacts • Info Flow w/Org Structure • Extensive Use of Hard Media • Constant, Known, Internal Sources of Info 	<ul style="list-style-type: none"> • Geographical Separation • Collaborative Work • Parallel Flow of Information • Time is Critical • Opportunistic Use of Technology • Dynamic Product Artifacts • Info Flow w/Project Structure • Nearly Exclusive Use of Electronic Media • Diverse, often Unknown, External Info Sources

27.5 Visualization

As virtual prototype testing is employed to quickly and efficiently test design hypotheses, various visualization routines may be utilized to test and verify manufacturability and assemblability of design, prior to production. Since agility requires that products be transitioned from design to production at the earliest practical point, it is critical that steps be taken to prevent delays incurred during production. Visualization accomplishes this objective in two ways. First, it may be employed as an interface to aid in the communication of manufacturing and assemblability concerns, and second, it may be used to verify manufacturability and assemblability.

During the design process, once CAD models of part designs have been developed, Computer-Aided Manufacturing (CAM) applications may be employed to quickly determine machine processes that will be required for parts fabrication. Starting with models of material stock, animated sequences of machine tool paths may be generated to illustrate the fabrication and problems that may be introduced by different facets of the design. Such illustrations provide an interface with which manufacturing may visualize the fabrication process in performing their own assessments, but equally important, it offers an interface that allows manufacturing to effectively communicate their concerns to design engineers.

Similarly, once models of a design assembly have been developed, automated routines may be used to generate assembly plans, and using these assembly plans, provide animated illustrations of the assembly process.¹⁷ Furthermore, where robot assembly will be employed, automatically generated assembly plans may be utilized to produce animated illustrations of robot assembly operations, for evaluation of the impact of a design on robot assembly workstations.¹⁷

27.6 Communications

A substantial portion of the reductions in product development time and improvements in quality realized with agility may be attributed to the application of communications and information technologies. The previous sections have discussed several such innovations: e.g., PDM and automatic notification of design changes.

27.7 Differences Between Agile and Traditional Enterprises

Table 27.1 summarizes several of the differences between communications within an agile and a traditional enterprise. The following sections discuss the implications of each of these differences.

Geographical Separation

Within traditional product development paradigms, often a new product was developed by a single company, with team members located in a single building or complex of buildings, utilizing local suppliers

for a customer within close proximity. All of these conditions minimized the burdens faced by geographically dispersed team members, organizations, and companies. In recognition of the inefficiencies introduced by geographical separation, “co-location” has often been recommended for teams as a means of enhancing concurrent engineering.

While co-location may facilitate communication between team members, enhance awareness of ongoing developments, and reduce bottlenecks to information flow, it assumes a business model that in many ways, contradicts key premises of agility. In particular, agility recognizes that it is not practical or cost-effective for a given company to maintain all of the capabilities necessary to bring many products to market. Instead, to attain a competitive advantage, companies must focus on their core competencies. As market opportunities develop, these companies may opportunistically combine their talents with other companies who have complementary capabilities, to form a Virtual Corporation.¹ For the life-span of the product, this Virtual Corporation would remain intact, and once this life-span comes to a close, the Virtual Corporation would dissolve, with each of its constituents following its own path.

Prohibitive costs and delays would be incurred were participants within a Virtual Corporation to attempt co-location. However, co-location does offer many benefits and with the capabilities introduced by communication technologies (e-mail, voice-mail, file transfer, desktop videoconferencing, collaborative work tools, internet and web-based technologies) and information technologies (PDMs, electronic product data, translators, automated tracking), Virtual Co-location provides a mechanism to allow distant and diverse companies to collaborate in new product development.¹⁸

The technology for Virtual Co-location is available; however the technology alone is not sufficient, as the need to work with geographically distant co-workers introduces many human factors and social obstacles.¹⁹ With co-location, communication between co-workers may occur in real-time, with immediate feedback. These conditions promote a very natural and efficient exchange of information. Electronic communications are not nearly as efficient in that communication often occurs asynchronously (e.g., a sequence of voice-mail exchanges), anything more than one-to-one communications is impractical (e.g., conference calls may be burdensome due to the need for only one person to speak at a time), and compared to face-to-face interchanges, electronic communications have impoverished information content (e.g., facial and gestural expressions are either not transmitted or are poorly communicated). Furthermore, it has been reported that users are generally less satisfied collaborating using videoconferencing and related technologies, as compared to face-to-face collaboration.²⁰

An additional challenge posed by Virtual Co-location relates to the absence of familiarity between collaborators. Workers who see each other daily and interact with one another on a regular basis develop a familiarity that may greatly enhance the efficiency with which they communicate.²¹

Various techniques may be employed to overcome the challenges posed by Virtual Co-location. Desktop videoconferencing removes much of the overhead typically associated with systems that require collaborators to leave their personal work spaces for specialized facilities. By combining telephone for voice and videoconferencing for visual, the drawbacks of digital voice communications may be avoided. Systems, such as Cruiser²² and Telepresence,²³ incorporate a variety of mechanisms to aid in the day-to-day, mutual awareness of co-workers. Collaborative work tools, such as Interactive Collaborative Environments (ICE), allow sharing of work tools (e.g., CAD software) between two or more geographically separated co-workers.²⁴ An additional advantage of collaborative work tools is that whereas specialists from various disciplines have traditionally been restricted to the role of reviewers, they may readily be drawn into the design process as co-designers by simply opening a shared session in which the designer and one or more others jointly work on a CAD representation of the design. Finally, specific measures (e.g., team building exercises) may be taken to help create a sense of familiarity between co-workers who will need to work together collaboratively using electronic media.²⁵

Collaborative Work

Traditional work processes have been dominated by a pattern in which team members meet in one place to review progress, discuss current issues, and assign work to various individuals. Afterward, the group disperses and the overwhelming majority of work is accomplished by individuals, working alone, with

little or no contact between team members. This approach emphasizes solitary work, a mode of operation often greatly favored by engineers due to the lack of distractions to the sustained concentration required to perform highly analytical tasks, and the opportunity to focus on tasks, without the cognitive overhead associated with social interactions.

While solitary work is still a common mode of operation within agile enterprises, there is a substantially greater emphasis on collaborative work. This emphasis results from the need to condense the design phase of product development into a very short period of time. To shorten the design phase, two things have to happen. First, delays associated with obtaining needed information or input from specialists must be minimized. Second, if a design path is not feasible, this needs to be determined at the earliest possible point, before precious time and resources have been committed. Both of these factors point to the need for collaborative work. Through collaborative work, input from specialists may be obtained almost immediately; time is not lost providing specialists with the background and design rationale they require to contribute to design; and potential problems and concerns may be identified and resolved before investing considerably in a particular design approach.

Reluctance, sometimes bordering on aversion, to collaborative work poses a significant problem. Within this reluctance, there may be an unwillingness by designers to relinquish the power to control design through their design decisions, and inclusion or exclusion of other disciplines, and an unwillingness among representatives of specialty disciplines to accept the responsibility for the success or failure of design that goes with being a collaborator in the design process.¹⁹ A culture of solitary work may be deeply entrenched, and the skills required for productive collaborative work may need to be trained and nurtured. Consequently, large-scale measures may need to be taken to bring about the changes in corporate culture necessary to thoroughly integrate collaborative work into the product development process.

Parallel Flow of Information

A key characteristic of an agile enterprise is that information is where it is needed, when it is needed.²⁶ Therefore, an important step in the migration to agility is the elimination of information bottlenecks within the product development process. Within traditional enterprises, information often flows sequentially. Information passes from person A to person B to person C to person D, instead of flowing to all four at once. Consequently, the transmission of information is slowed, with it often being irrelevant by the time it reaches individuals late in the routing scheme. Likewise, as information is re-transmitted by different individuals, it may often be corrupted, either intentionally or nonintentionally. Furthermore, power is often derived from withholding information, resulting in information being withheld for the benefit of a few, but to the detriment of many.

Agility introduces a transition from sequential to parallel information flow. One example, previously discussed, is the use of automatic notification of design changes. E-mail and voice-mail have both provided mechanisms that enable information to be easily broadcast throughout an organization. With the parallel flow of information and the accompanying ease with which information may be broadcast, concern arises that information overflow may become an unwelcome by-product of these technical innovations. Currently, available mechanisms for filtering incoming information are, at best, partially effective. This results from their reliance on either keyword-based sorting routines or sender-assigned prioritization. With either approach, their effectiveness is directly proportional to the effectiveness with which users can either select an effective set of keywords or deploy a prioritization scheme. In neither case is there evidence that users are particularly effective.

All of the approaches discussed in the previous paragraph rely on a push-model of information distribution, information is pushed from a single point out along defined distributions. An alternative that alleviates some of the problems of information overload is to apply a pull-model, in which information is made available at a single or multiple source points (multiple source points may be desirable when delays are likely due to heavy network traffic), and individual users download the information at their own convenience. Corporate, Web-based intranets provide an effective interface for implementing such a pull-model for information distribution within an enterprise. The primary drawback to the pull-model is that users must know the information is available in order for it to be requested. Consequently,

it becomes necessary to develop user interface concepts that allow users to quickly and efficiently review available information and of equal, if not greater importance, provide sufficient cues for the users to make their decision regarding whether the information will be of sufficient value to justify its download.

Time Criticality

The relationship among cost, schedule, and performance whereby a reduction in cost leads to an increase in schedule and/or decrease in performance is an often-cited axiom of engineering management. As evidence of this three-way relationship, schedule is often negotiated when stringent cost and, especially, performance requirements are introduced by the customer. Agility seeks to violate this axiom by applying technical, organizational, and process innovation to drastically reduce schedule, without affecting cost and if anything, improving quality (however, it may be argued that the axiom still applies since investments are required up front to attain agile capabilities). To negotiate schedule is contrary to the spirit of agility, since the general aim is invariably to produce quality, custom product as fast as possible. Therefore, in transitioning to agility, every effort should be made to identify bottlenecks in the product development process that delay new product development, and either eliminate or substantially reduce those delays.

The identification of bottlenecks in the product development process requires a systematic analysis of the sequence of events necessary to bring new product to market.¹⁸ Task analysis offers an effective analytic approach for obtaining the information needed to streamline product development. Through interviews, and review of corporate guidelines and process specifications, a detailed task analysis may be developed that illustrates the sequence of events by which product development occurs. Typically, simple qualitative assessments will yield a number of process improvements. For further process optimization, the task model of the product development process may be incorporated into a network simulation to quantitatively evaluate the elapsed time and utilization of resources throughout the process. Similarly, methods from Human Reliability Analysis²⁷ may be applied to estimate the likelihood of human error at various points throughout the process and the overall ramifications of specific human errors.

Opportunistic Use of Technology

Technology standardization is a common approach applied in the attempt to realize enterprise-wide efficiency and reductions in cost. Encouragement to pursue this approach comes from vendors, who often offer substantial price reductions for large purchases. Although, on the surface, standardization seems like a straightforward solution, it is often not conducive to agility. Within computer user communities with no or minimal corporate pressure for standardization, heterogeneity is typically the rule as different users gravitate to platforms and software applications that best meet the requirements of their jobs, skills, experience, and knowledge, and with which they are generally satisfied. Where corporations apply pressure for standardization, it has been observed that users will invariably find ways to violate the standard, and introduce nonstandard hardware and software. Likewise, users express strong, sometimes nearly religious, loyalties to their preferred computer platform and software applications, resulting in considerable discontent when efforts are undertaken to deny users their preferences for the sake of standardization. Additionally, standardization hampers the efficiency with which a company may interface with other companies, excepting the improbable case where two companies have adopted comparable standards.

For the above reasons, the agile enterprise tends not to invest monetary and human resources in standardization, but instead pursues an opportunistic approach to technology utilization. Thus, there is an acknowledgment of heterogeneity and investment in solutions that allow people to work together, despite their using different computer platforms and software applications.

Dynamic Product Artifacts

Moving at a much slower pace, the artifacts generated following traditional design approaches are generally rather static. Great emphasis is placed on developing requirements that are firm, with considerable negotiation surrounding any change, once requirements have been fixed. During early conceptualization, design concepts

may evolve fairly rapidly, but generally, acceptance of a design concept occurs fairly early, after which, there may be an extended progression from conceptual to detailed design. During this progression, there is a pervasive tendency to commit to various facets of design, and often, dissatisfaction is expressed when design team members attempt to revisit design decisions. In general, economy is sought by making design decisions early, and sticking to those design decisions, so that there is minimal effort expended on design paths that are ultimately rejected.

With agility, two factors lead to a more dynamic design process. First, design automation and reuse of product data reduce much of the pressure to push forward the beginning of detailed design development, allowing greater freedom to explore alternative design concepts. Second, virtual prototype testing makes it practical to explore innovative design concepts that otherwise would have been too risky to invest the time and resources. Consequently, in the conceptual design phase, a given product design may undergo numerous permutations, but once a design has been accepted, fabrication may begin almost immediately.

However, with an agile enterprise, there is no less concern for time and resources being wasted on unproductive design paths. Thus, during conceptual development, when design is in rapid flux, the design team must function as a coordinated unit, moving to apply the appropriate resources, but carefully steering and gauging those resources to maximize the return on investment. To function in such a manner requires that members of the design team have an ongoing situation awareness of the design progression, the efforts of their colleagues, and, as needs arise, that they must fill an anticipation of those needs, so that they may move quickly and effectively to provide the needed inputs to the process.

Information Flows in Accordance with Project Structure

As stated previously, information is often synonymous with power and may be used as currency within the social dynamics of an organization. To the detriment of the organization, information may not flow along paths that are most expedient and productive, but follow paths defined by organizational or other political structures. For example, it is not uncommon for Engineer A to inform his superior that assistance is needed from Engineer B, who then contacts Engineer B's superior about securing the services of Engineer B. An agile enterprise cannot afford the inefficiency of such an exchange, but instead, would encourage direct communication between Engineers A and B. To supersede politically defined paths of communication, an enterprise must instill a culture wherein there is sufficient empowerment of workers to enable direct lines of communication. Likewise, embodied within this culture is an openness and willingness to share information that far surpasses that found within the vast majority of traditional enterprises.²⁶

Electronic Media

While it may not be practical for an enterprise to eliminate all paper transactions and become truly paperless, there are countless efficiencies that may be gained from eliminating paper exchanges. All facets of the enterprise may be affected. Administrative functions may be streamlined through providing open access to corporate data (e.g., financial records, procurement processes, property management). Human Resource functions may be brought on-line through open access to employee benefits, vacation balances, and to the extent allowed by confidentiality, personnel records. Policies, Handbooks, Guides, and similar corporate documents may be made widely accessible through electronic media, achieving the added benefit of assuring that all employees have the most current versions.

Whereas traditional enterprises see extensive exchange of paper between workers in technical positions (e.g., memos, reports, schedules, etc.), most of these exchanges could be easily accomplished through electronic media. For example, e-mail may be employed for most correspondence. Similarly, Web-based intranets enable the posting of most documents, so that those interested may readily view the contents, and if sufficiently interested, download or print the document.

Applied to product development, electronic media enable a near-seamless progression from concept to finished deliverable. Hand-drawn sketches may be transitioned into CAD models. These CAD models

may be converted to true 3-D representations, suitable for generation of finite element models on which virtual prototype testing may be conducted.⁵ Similarly, CAD models may serve as a basis for developing machine tool paths, from which machine code may be derived. Furthermore, 3-D representations may be used to generate assembly plans and from there, robot code for the final assembly. In each of these cases, through the use of electronic media combined with various translation, conversion, and automation routines, design progresses through the various stages of product development seamlessly, without the laborious activities associated with developing hard media and converting from hard media to either another form of hard media or electronic media.

Diverse, Often Unknown, External Information Sources

With traditional enterprises, information sources remained relatively constant from project to project. The same engineering groups, with mostly the same personnel, relied on the same support groups, similarly, with mostly the same personnel. Although obtainable information may have been limited to the capabilities and resources of the people providing information, there was constancy and familiarity. Within Virtual Corporations, personnel will vary from project to project, as will the information sources that are utilized. Familiarity of project personnel was discussed in an earlier section. With regard to variability of information sources, several concerns arise.

With the agile enterprise, there are more plentiful and richer sources of relevant information than has ever been the case. This information may be internally derived, such as corporate archives, or externally derived, such as public or commercial databases. The first problem concerns the filtering of available information to locate relevant data. Numerous utilities have been offered for searching large information spaces. However, most of these employ keyword-type searches, and although Boolean operators may be used to define relatively sophisticated search conditions, skills are required that exceed those of the vast majority of users. Furthermore, the effectiveness of such interfaces hinges on the user's ability to define successful search parameters, a task that is often difficult for even skilled information retrieval specialists. The second problem relates to the presentation of search results, a problem that is exacerbated by the inadequacy of interfaces for search definition. With most currently available utilities, search results are presented as a list of hits that may be ordered with regard to the incidence and placement of keywords, and may provide a brief excerpt. Given the investment of time associated with retrieving and reviewing each returned item, such an interface is highly inefficient for extracting answers to specific questions. However, as illustrated by the TileBars²⁸ interface, noteworthy progress has been made with regard to interface concepts for display of search results and similar progress may be anticipated for interfaces to aid in extracting information, once source documents have been located and retrieved.

27.8 Ergonomics of the Agile Shop Floor

Most discussions of agile manufacturing focus on its impact on design and business operations. The view of agile manufacturing from the shop floor is quite different from that of a product designer, manager, or administrator.

Human errors during production can be tremendously costly and will be more so as production runs grow smaller and more customized. The actual cost of human error would be useful to know; unfortunately it is difficult to gather this information. There are several reasons for this. First, there is a stigma associated with error, such that neither technicians nor supervisors are eager to admit or discuss their mistakes. Second, at some level in a company, there may be an urgent desire to understand and contain costs, but there is little reward for making such information public. Third, even industries that are well suited to capture the cost of human error on the factory floor are not very good at doing this. In the semiconductor industry, for example, the lack of standardized human-computer interfaces in semiconductor factories costs millions in "mis-processing" errors. Even though there exist formal organizations in this industry whose sole purpose is to produce and promote industry standards, to date this problem has largely gone unaddressed.²⁹

The causes of human error on the production floor are numerous. First, the agile manufacturing paradigm, by its nature, assumes rapid response to customer demands. Agility is characterized by a remarkable confluence of people, skills, materials, facilities, and equipment to produce a product as quickly as possible. The dominant reality on the factory floor, therefore, is often that the production schedule drives everything. This is an environment highly prone to produce numerous human errors. The frenetic atmosphere that accompanies agile manufacturing is an over-arching factor that constrains every decision, pushing everyone at all levels away from optimal solutions to merely pragmatic ones. Some of the most potent sources of error in an agile manufacturing environment are discussed below. They are mentioned briefly here, although much has been written about each.

Operator Selection and Training

Successful manufacturing requires operators who bring basic skills to the job. These people are also specially trained to operate particular pieces of equipment. The operator selection process ranges from informal, where an experienced operator might take on an apprentice who seems to “have his wits about him,” to formal, where minimum scores are necessary on performance tests to be considered for a job. In any case, by some process, people are chosen to work on the factory floor.

Regarding training, one of the most important determinants of success is that the training accurately represents the actual performance situation. Therefore, hands-on training to a criterion level of performance is essential for classroom training. On-the-job training is often effective (with quality feedback), particularly in conjunction with in-class training, provided close supervision is maintained for long enough (exactly how long is specific to the task being trained). It is known, for example, that around 100 hours of flight time is a troublesome period for new pilots as they transition to a more sophisticated level of performance beyond rote performance. A similar phenomenon should be anticipated for shop floor tasks, as well.

Procedures

One of the most potent factors shaping human performance on the factory floor is written work procedures. Work is often performed, unfortunately, without written work procedures of any kind. At the least, such situations run the risk of producing substandard products. More significantly, workers may begin to disregard safety and health risks, as such risks become routine through day-to-day exposure.

Shift Work

Taking a broad definition of shift work as anything outside of 7 am to 6 pm, approximately 20 to 30% of the workforce participates in shift work.³⁰ In fact, this percentage should be higher in agile manufacturing environments because of the time pressures discussed earlier. Shift work has an inherently negative affect on human performance, because it disrupts the body’s normal biological rhythm. All things being equal, performance should be expected to suffer somewhat among shift workers, particularly on tasks that require decision-making.³¹

Human–Computer Interfaces

Software that is difficult to use promotes human errors. Most modern process machines now use computer screens as their dominant user interface. Also, procurement and planning software tools are an integral part of the modern factory. Travelers, work instructions, etc. are displayed from shop floor computers. For the most part, these interfaces have not met their potential to help operators control processes or make better decisions, though this is slowly changing. The fact is, most of these large tools are purchased on the basis of factors other than their usability, and most buyers have no way to determine the ergonomics of a user interface. If the vendor says it is user friendly, that is usually as far as it goes, if the question is even asked.

Safety Procedures

Accidents happen, and sometimes when they do, they cause damaged product, thus affecting the success of agile manufacturing. Many accidents happen because of nonconformance with published safety policies, and often management must bear some blame for this fact. It is often the case that, in the drive to meet schedule, plant management pushes priorities that send the message to the floor that safety can be compromised.

Shop Floor Culture

In any complex manufacturing enterprise, social groupings form based on educational background, status, and function. Usually, an informal caste system evolves with production technicians at the lowest level, engineers and other specialists in the middle, and management at the top. Production technicians, because they work together and often share the belief that they are under-appreciated by members of the other social groupings, tend to develop a unique shop floor culture. This is important to understand, because it can hurt or help an agile enterprise. Shop floor technicians are often very aware of ergonomically poor situations. However, as a group, typically, they are proud of their abilities and may take it as a suggestion of their own shortcomings that a situation is pronounced “error-likely.” A specialist, intent on making ergonomic improvements, must gain the trust of the technicians, being careful to give them ownership in the result.

27.9 Conclusion

It has been often reported that major technological innovations have met with unsatisfactory results due to inattention to human factors.³¹ The previous sections have summarized many of the human factors faced as enterprises migrate from traditional to agile modes of operation. Particular emphasis has been placed on the product development process, communication, and information utilization, all areas that have proven significant during agile manufacturing efforts undertaken at Sandia National Laboratories.⁵ Admittedly, some significant issues have been omitted, most notably those associated with developing an “agile workforce”,³² and sociotechnical issues³³ related to the introduction of new technologies and business practices. Furthermore, with the spectacular rate of innovative growth in information technologies, the factors identified here are likely to be amplified, while many new considerations are introduced.

Acknowledgment

This work was supported by the United States Department of Energy under Contract DE AC04-95AL85000.

References

1. Nagel, R.N. and Dove, R., *21st Century Manufacturing Enterprise Strategy*, Iacocca Institute, Lehigh University, Bethlehem, PA, 1992.
2. Shunk, D. L., Patterson, W. and Ames, J. G., A report on the results of an agile pilot project: The Nationwide Electronics Industry Sector Pilot (NEISP), in *Proc. Fifth National Agility Conference*, Boston, MA, 1996, 9.
3. Hoy, T., VanderBok, R. and Margolin, D., Manufacturing Assembly Pilot (MAP) improving supply chain performance, in *Proc. Fifth National Agility Conference*, Boston, MA, 1996, 14.
4. Kinsella, E. M., Kinsella, M. D., Swanson, E. T. and Etue, J., Size doesn't matter: How very small (30 employees) businesses used agile practices to help Whirlpool Corporation launch their state-of-the-art dryer in record time, in *Proc. Fifth National Agility Conference*, Boston, MA, 1996, 68.
5. Forsythe, C, Ashby, M. R., Diegert, K. V., Parratt, S. W., Benavides, G. L., Jones, R. E. and Longcope, D. L., *A Process for the Agile Product Realization of Electro-Mechanical Devices*, SAND Report Number 95-0536, Sandia National Laboratories, Albuquerque, NM, 1995.

6. Brost, R.C., Strip, D.R. and Eicker, P.J., The technology base for agile manufacturing, in *Proc. of the NASA Workshop on Space Operations*, Houston, TX, 1992, 522.
7. Diegert, K. V., Easterling, R. G., Ashby, M. R., Benavides, G. L., Forsythe, C., Jones, R. E., Longcope, D. L. and Parratt, S. W., Achieving agility through parameter space qualification, in *Proc. Fourth National Agility Conference*, Atlanta, GA, 1995, 331.
8. Comerford, R., The flexible factory: case studies, *IEEE Spectrum*, 30 (9), 28, 1993.
9. Tweedie, L., Spence, B., Dawkes, H. and Su, H., The Influence Explorer (video) — a tool for design, in *Proc. Human Factors in Computing Systems*, Vancouver, BC, 1996, 390.
10. Hauge, P. L. and Stauffer, L. A., ELK: A method for eliciting knowledge from customers, in *Proc. Design Theory and Methodology*, Albuquerque, NM, 1993, 73.
11. Ramaswamy, R. and Ulrich, K., A designer's spreadsheet, in *Proc. Design Theory and Methodology*, Albuquerque, NM, 1993, 105.
12. Helander, M., Models of design for concurrent engineering, in *Advances in Agile Manufacturing: Integrating Technology, Organization and People*, Kidd, P. T. and Karwowski, W., Eds., IOS Press, Washington, D.C., 1994, chap 4.
13. Nakazawa, H., Human oriented manufacturing systems, in *Advances in Agile Manufacturing: Integrating Technology, Organization and People*, Kidd, P. T. and Karwowski, W., Eds., IOS Press, Washington, D.C., 1994, chap 2.
14. Forsythe, C. and Ashby, M.R, Human factors in agile manufacturing, *Ergonomics in Design*, 4(1), 15, 1996.
15. Forsythe, C. and Ashby, M.R., User-driven product data manager system design, in *Proc. Human Factors and Ergonomics Society*, San Diego, CA, 1995, 1170.
16. Goel, V., *Sketches of Thought: A Study of the Role of Sketching in Design Problem Solving and Its Implications for the Computational Theory of Mind*, Dissertation, University of California, Berkeley, CA, 1991.
17. Jones, R.E., Ames, A.L., Calton, T. L., Kaufman, S.G., Laguna, C.A., Rebeil, J.P., Saavedra, M., Wilson, R.H. and Woods, R.O., *The Automated Assembly Team Contributions to the {A-PRIMED} Agile Manufacturing Project*, SAND Report Number 95-1340, Sandia National Laboratories, 1995.
18. Forsythe, C. and Ashby, M.R, *Developing Communications Requirements for Agile Product Realization*, SAND Report Number 94-048, Sandia National Laboratories, Albuquerque, NM, 1994.
19. Forsythe, C., Human factors in agile manufacturing: a brief overview with emphasis on communications and information infrastructure, *International Journal of Human Factors in Manufacturing*, 1997, 3-10.
20. Olson, J.S., Olson, G.M. and Meader, D.K., What mix of video and audio is useful for small groups doing remote real-time design work? in *Proc. CHI 96 Human Factors in Computing Systems*, Vancouver, BC, 1996, 362.
21. Krause, R. M. and Fussell, S. R., Mutual knowledge and communication effectiveness, in *Intellectual Teamwork*, Erlbaum, Hillsdale NJ, 1990, 111.
22. Rosenberg, J., Kraut, R.E., Gomez, L. and Buzzard, C.A., Multimedia communications for users, *IEEE Communications*, 1992, 20.
23. Buxton, W.A.S., Telepresence: integrating shared task and person spaces, in *Proc. Graphic Interface 92*, Vancouver, BC, 1992, 11.
24. Ashby, M.R. and Lin, H.W., Interactive Collaborative Environments (ICE): platform independent X application sharing and multi-media over wide area networks at Sandia National Laboratories. in *Proc. Fifth International Symposium on Robotics and Manufacturing*. Maui, HI, 1994.
25. Forsythe, C. and Ashby, M.R., Ramping up for agility: development of a concurrent engineering communications infrastructure, in *Proc. Fifth National Agility Conference*, Boston MA, 1996, 1062.
26. Goldman, S. and Preiss, K., *21st Century Manufacturing Enterprise Strategy. Volume 2. Infrastructure*, Lehigh University, Bethlehem, PA, 1992.
27. Gertman, D.I. and Blackman, H.S. *Human Reliability and Safety Analysis Data Handbook*, John Wiley, New York, 1994.

28. Hearst, M.A., TileBars: visualization of term distribution information in full text information access, in *Proc. CHI 96 Human Factors in Computing Systems*, Vancouver, BC, 1996, 59.
29. I. Miller, D.P. and Whitehurst, H.O., *Preventing User-Hostile Interfaces in IC-Fab Equipment: Ergonomic Approaches for Preventing Ten Frequent User-Interface Problems*, Sematech Technology Transfer Report #92091299A-ENG, Sandia National Laboratories, Albuquerque, NM, 1992.
30. Monk, T.M. and Folkard, S., *Making Shift Work Tolerable*, Taylor & Francis, London, 1992.
31. Mitton, R. and McLoughlin, I., "A lack of fit?" the adoption of Japanese style manufacturing techniques in Britain, in *Advances in Agile Manufacturing: Integrating Technology, Organization and People*, Kidd, P. T. and Karwowski, W., Eds., IOS Press, Washington, D.C., 1994, chap 11.
32. Plonka, F.E., Developing a lean and agile workforce, *International Journal of Human Factors in Manufacturing*, 1997, 11-20.
33. Baba, M.L. and Mejabi, O., Advances in Socio-technical systems integration: object-oriented simulation modeling for joint optimization of social and technical subsystems, *International Journal of Human Factors in Manufacturing*, 1997, 37-61.

28

Occupational Safety in Robotics

Mansour Rahimi
University of Southern California

28.1	Introduction	28-1
28.2	Robot Accidents and Safety Analysis.....	28-2
28.3	Risk Zones for Stationary Robots.....	28-4
28.4	Robotic Safety Standards.....	28-5

28.1 Introduction

The robotics industry is expecting a doubling in total revenues between 1994 and 2001 (*Robotics World*, 1995). Even though the annual growth rate is expected to average 9.6% for all types of robots, the percent of growth will be substantial in material handling (28.6%), welding (25.7%), and material application (17.2%) by the year 2001. It is expected that the new business is likely to come from the implementation of long-term, customer-based strategies rather than from the aggressive marketing that took place in the market's infancy during the 1980s. According to McAlinden (1995), the world now uses more than 0.5 million robots. The robotics market analysts believe that such an increase in robotic applications will only be sustained by the ability of robot designers and producers to diversify outside the traditional automotive industry into nonautomotive areas such as: food/beverage and consumer products, pharmaceuticals, computer and consumer electronics, and telecommunications. Also, a paradigm shift has also been noticed in the use of robots from an individual robot cell application to a broader integration into the overall manufacturing system including product and process flow integration, generating 20% of revenues in 1994.

This sharp increase in the use of robotic systems in the past three years has renewed interest in the occupational safety aspects of these sophisticated machines. The following two incidents highlight the potential *hazards* that a computer-controlled robot may pose to people who work with (and around) these machines. These incidents occurred in a robotics laboratory and are directly quoted from a news bulletin at RISKS@SRI-CSL.ARPA. "In the first incident, a 68000 board in our system failed and caused the processor to jump to (of all places) a robot move routine. We were all standing around the *emergency stop* button looking at a terminal, and Jeff and Talia got to the button within a few milliseconds of hearing the crunching noise which marked the premature demise of a small jack belonging to the lab. With our sensor mounted on the *end-effector* as it was, it could have been a lot worse if we had been further from a kill button." The second incident was described as "Some drive motor cards in the Cincinnati-Milacron box failed and joints 5 and 6 began jerking around randomly. Again, the kill button was nearby ... It could have been any other joint — including the base or the shoulder. And someone could have been standing next to it. We do that all the time. It can and does happen. Watch yourselves around robots."

TABLE 28.1 Some Causes of Robot-Related Accidents

Design and Engineering Factors	
Robot system failures (mechanical, electrical, etc.)	
Peripheral machine malfunctions	
Inadvertent robot movement	
Software design and control malfunctions	
Failure to halt all robot movements	
Unexpected starts and halts	
Gripper design problems	
Improper design of control panel and its functions	
Inadvertent contact with start buttons and other switches	
Unreliability of the existing robot safety devices	
Excessive robot arm speed	
Existence of other sources of hazards (e.g., chemical, noise)	
Behavioral and Organizational Factors	
Worker entering danger zone of a halted robot for:	
trouble-shooting	
repair	
testing	
maintenance	
teaching	
Unauthorized entry into general robot work area	
Inappropriate robot start-up procedure	
Inappropriate work-piece adjustment and repositioning	
Inappropriate robot teaching mode and maintenance procedures	
Inappropriate change of tooling	
Worker unaware of robot's programmed (unpredictable) movement	
Intentional disabling of safety devices	
Improper lockout/tagout procedure	
Lack of targeted safety training for managers, engineers, and operators	

28.2 Robot Accidents and Safety Analysis

Statistics on robotic accidents and injuries are spurious and somewhat unreliable. Robot manufacturers and *users* seldom publish any relevant robot safety and health related information. Similarly, mandated federal and state accident reporting systems do not contain a significant number of accidents labeled as robot injuries. However, due to the nature of robots and the unpredictability of their motion sequences, some robot injuries may be severe with major disruptions in the company's operation. For example, a death caused by a robot resulted in a \$10 million lawsuit and the closure of an automotive plant. The only significant robot injury data sources and analyses have been from Backstrom and Harms-Ringdahl (1983), NIOSH (1984), and Sugimoto (1987).

The type of injuries from robots may be classified as direct impact (e.g., cuts, lacerations, crushing), electrocutions, airborne contaminants (e.g., welding gases, acid fumes, irritants, systemic poisons), hazardous material (e.g., process chemicals), nonionizing and ionizing radiation, high temperature and fires, noise, and biohazards (for a description of each hazard see Brauer, 1990). This chapter deals with hazards from stationary (nonmobile) production robots only.

Since some robot injuries may be serious, a number of hazard analysis techniques have been suggested to assess the hazardous conditions of a robotic system. A robot hazard analysis technique was introduced by Rahimi (1986) using the concept of energy *barrier* analysis. This study introduced the sources of robot hazards into two categories listed in Table 28.1. The study suggested a five-step approach to minimize the robotic system hazards:

- a. Improving mechanical reliability and hardware component design of robotic systems.
- b. Incorporating software safety controls for all phases of robot operations.
- c. Developing a robot *presence-sensing* capability to detect human proximity.
- d. Incorporating ergonomic design considerations for human–robot workstation layout and operations.
- e. Using effective safety training systems for individuals associated with robot operation, testing, and maintenance.

In another study, Seward, Bradley, and Margrave (1994) present a safety life cycle model which involves a two-step analysis process. Step 1 uses the data from five input variables: robot physical characteristics, robot goal specification, environmental considerations, safety criteria, and safety regulations and constraints. The risk analysis in Step 1 produces the functional control system specifications and safe and unsafe states of the robotic system. Then the outcomes from Step 1 are inputted into Step 2, analysis of control system specification, which produces any revisions to the current functional control system specification, specific safety requirements, and information requirements, and robot control interfaces with other machines and tools. In order to perform specific safety analyses in Step 1, Seward et al. (1994) suggest a number of techniques regularly used in system safety analysis (see also Rahimi, 1995). The following is a short description of some of these techniques.

Preliminary Hazard Analysis. This simple technique is usually used as the first step to prepare for more detailed analysis. It is an organized way of collecting crude data on system components and their hazardous characteristics. The purpose is to generate a list of hazards inherent in the system. A good starting point is to generate the list based on the sources of potentially hazardous *energy sources* in the system.

Failure Mode, Effects, and Criticality Analysis. Unlike PHA, which lists hazards in the overall system, FMECA analyzes the components of the system and all of the possible failures that can occur in each component. In this analysis, each item's function must be determined. Once this is done, the causes and effects of the failure of the components are indicated. Then, the criticality factor for each failure is determined, and a quantified severity rating is given to the factor. Since the frequency of each potential occurrence is also an important factor, a risk assessment matrix can be used to codify the risk assignment (see Rahimi, 1995). A team of experts can then use this information to redesign robot work cell components or configurations to reduce the criticality ratings that are high or unacceptable.

Hazard and Operability Study. HAZOP is a systematic study of the hazards in a complex system. The system operation is broken down into a set of nodes. Each node contains information on the procedure or specific machines and is then interconnected logically with other nodes in the system. A team of specialists is formed who systematically question every aspect of every node of a system and its operation using a set of key "guide words" (e.g., more, less, as well as). Using these guide words on every node will determine the possible deviations from the planned operation which may cause hazardous conditions. Each deviation is then considered in turn to establish how it is caused and what the consequences are. Unrealistic causes and trivial consequences are ignored. Important causes and consequences are examined at a later stage to establish how they can be eliminated or reduced to an acceptable level.

Fault Tree Analysis. FTA is a top-down or deductive reasoning approach to the elements of a chain of events which leads to an undesired event (e.g., accident, injury). These events are linked by an event tree structure (pyramid style) to the top undesired event using logic connections such as AND or OR functional interpretations. There are four main types of events in any fault tree: (a) a basic event which is the final event in the fault tree, initiating the failure process as a root cause, (b) a fault event which is considered to be the in-between event (not an end event), (c) a normal event which is an existing event which may or may not contribute to the fault propagation, and (d) an undeveloped event which requires more investigation because of its complexity or lack of analytical data. For example, in its simplest form, a robotic injury may be linked to a software control failure and a mechanical stop switch failure. A fault tree can be constructed in which an AND gate connects these two failures, leading to the possibility of such injury. Probabilities of robot injuries can also be studied using quantitative FTA for specific robot installations (Rahimi and Roland, 1989).

28.3 Risk Zones for Stationary Robots

Robot workstations are temporally and spatially dynamic. Work spaces within a robot workstation can be defined and modified based on the speed of the robot arm (e.g., see Karwowski and Rahimi, 1991), number and size of the robot tool exchange mechanisms, variabilities in the part and workpiece feeders and extractors, design of the conveyor systems, cooperation with the adjacent robots, and the most variable of all these elements, the operator's behavior. Therefore, allocating risk (danger) zones to a robot work zone becomes a major determinant of the overall safety of a robot workstation. One can take a sophisticated approach of mathematically formulating and predicting the probability of operator collision in the vicinity of a stationary robot workstation (Giusti and Tucci, 1994). Since robot workstations are highly flexible, the use of such time-consuming mathematical computations on actual factory floors may be impractical. A more practical approach is to follow a simple heuristic to determine robot danger zones and possible means of protecting workers, machines, and workpieces around robots. Each zone and a generic approach to its *safeguarding* is presented here.

1. *Adjacent to the Workstation.* Workers may walk around the general vicinity of a robot for a variety of reasons. A hazard prevention approach is to attract the worker's attention by appropriately designed robot warning signs and robot arm color coding.

2. *Approaching the Workstation.* The worker is still at a distance from the robot actual work zone. Therefore, there is no need for a robot controller action, except a flashing yellow warning light which can be seen from all different locations surrounding the robot.

3. *Zone 3 (envelope).* This working zone is inside the robot work envelope plus any hazardous area within the zone caused by operation of peripheral machines and work-piece handling devices. This zone is usually marked by perimeter fencing, fixed and removable *barriers* and gates, modular hand rails, woven wire partitions, in addition to safety sensors (e.g., pressure sensitive mats, photoelectrics). Entering this zone should also trigger warning buzzers, yellow flashing lights, and/or red lights. The robot speed of motion should also be adjusted to reduce potential impact hazards.

4. *Zone 2 (restricted envelope).* This zone encompasses all points where the robot arm and its associated equipment can travel in a three-dimensional space. (**Note:** majority of everyday robot operations do not extend the robot arm at its maximum distance.) In addition to red flashing lights and a warning buzzer, this zone should contain both pressure mats and light curtains. The robot control routines should be designed to freeze the arm. However, such an action should not create other dangers to the intruding worker, such as release of workpiece, or release of other environmental hazards. The control reactivation should allow normal production once the worker leaves this zone.

5. *Zone 1 (operating envelope).* This zone contains the immediate proximity to the robot arm, gripper mechanisms, actual piece being handled, and other sources of hazardous energy associated with the robot work cell. Intrusion into this zone should place the robot into an emergency stop and activate all warning lights and buzzers at their maximum capacity. To prevent severe impact injuries, the robot arm should have proximity and/or touch sensors with a *fail-safe* release mechanism. A formal restart procedure is necessary to resume the operation. Safeguarding this zone becomes a formidable task if a robot end-effector is cooperating with a human worker to perform a specific task. In cases where multiple human-robot work tables are being used for production (e.g., a shift workstation), robot controlled light curtains may be recommended. The light curtain limiting switch is turned on when the robot approaches the work table to perform its task routine, leaving the other work table free for the human worker to operate.

A word of caution is that each robot work-cell is different in terms of its design and the layout of its associated machinery and equipment. Each workstation design must be carefully studied for a comprehensive robot safety analysis. The next section briefly discusses the minimum requirements (standards) for robot safety.

28.4 Robotic Safety Standards

Countries with large populations of robots (i.e., United States, Japan, United Kingdom, Germany, France, Russia) have developed regulations, codes, and standards to govern their robot safety practices. In many respects, these documents differ in their formats and contents. In the United States, a voluntary standard has been produced by the American National Standards Institute with cooperation from Robotics Industries Association (ANSI/RIA, 1992). As of now, a mandatory U.S. federal standard specifically designed for robotic systems has not been developed. However, the general machine guarding section of the Occupational Safety and Health Administration, General Industry document (OSHA 29CFR1910-212) can be applied to robotic safeguarding. This clause states that: "... One or more methods of machine guarding shall be provided to protect the operator and other employees in the machine area from hazards such as those created by point of operation, in-going nip points, rotating parts, flying chips, and sparks. Examples of guarding methods are: barrier guards, two-hand tripping devices, electronic safety devices, etc." Therefore, it is the duty of every robot user to protect the workers from potential robot hazards. The means by which such protection can be assessed should be accomplished by careful analysis of the robotic workstation and application of relevant concepts such as the ones stated in the ANSI/RIA standard. Table 28.2 is a selected (partial) list of items in this standard. The original section numbers have been kept for ease of reference. For a discussion of the standards from other countries, the reader is referred to a publication by the International Labor Office (ILO, 1989). The ILO document also contains a comparison table as a cross reference checklist of standards from the six countries mentioned above. As mentioned earlier, following these standards appears to constitute only minimum requirements for the safety of workers around industrial robots. Also, these standards are not designed for a myriad of other robot applications such as construction, health care, mobile robots, etc. Figure 28.1 is presented to demonstrate the robot danger zones and the various safeguarding devices used in a typical robot installation. Figure 28.2 is presented to illustrate the concept of a human-robot cooperative work-cell and a solution to protect workers from possible injuries.

Defining Terms

- Awareness device or signal:** A device that by means of audible sound or visible light warns a person of an approaching or present hazard.
- Barrier:** A physical means of separating persons from the restricted envelope (space) where a danger may be present.
- Emergency stop:** The operation of a circuit using hardware-based components that overrides all other robot controls, removes drive power from the robot actuators, and causes all moving parts to stop.
- End-effector:** An accessory device or tool specifically designed for attachment to the robot wrist or tool mounting plate to enable the robot to perform its intended task. Examples may include gripper, spot weld gun, arc weld gun, spray paint gun, or any other application tools.
- Energy source:** Any electrical, mechanical, hydraulic, pneumatic, chemical, thermal, potential, kinetic, or other source of energy.
- Envelope (space), maximum:** The volume of space encompassing the maximum designed movements of all robot parts including the end-effector, workpiece, and attachments.
- Fail-safe:** A mechanism by which any failure of the robot components will place the robot into a safe or zero energy state.
- Hazard:** A condition that is likely to cause personal harm or damage to equipment.
- Interlock:** An arrangement whereby the operation of one control or mechanism allows or prevents the operation of another.

TABLE 28.2 A Partial List of Items Found in the U.S. ANSI/RIA R15.06 Voluntary Standard

ANSI/RIA Section Numbers and Section Title	
4.2	Hazard to personnel
4.2.1	Moving parts
4.2.2	Component malfunction
4.2.3	Sources of energy
4.2.4	Stored energy
4.2.5	Electromagnetic interference, radio frequency interference, and electrostatic discharge
4.3	Movement without drive power
4.4	Actuating controls
4.4.1	Protection from unintended operation
4.4.2	Status indication
4.4.3	Labeling
4.4.4	Remotely located controls
4.5	Emergency stop
4.6	Pendant
4.6.1	Automatic
4.6.2	Motion control
4.6.3	Pendant emergency stop
4.6.4	Single point of control
4.6.5	Initiated motion
4.7	Attended continuous operation
4.8	Slow speed control
4.9	Mechanical stops
4.10	Provisions for lifting
4.11	Electrical connectors
4.12	Hoses
4.13	Power loss or change
4.14	Failures
4.15	Required information
5	Installation of robots and robot systems
5.1	Installation specification
5.2	Grounding requirement
5.3	Power requirements
5.4	Control location
5.5	Robot system clearance
5.6	Power disconnect
5.7	Limiting devices
5.8	Environmental conditions
5.9	Associated equipment shutdown
5.10	Precautionary labels
5.11	Restricted envelope (space) identification
5.12	Dynamic restricted envelope
5.13	Robot system emergency stop
5.14	End-effector power loss/change
6	Safeguarding personnel
6.1	Responsibility
6.1.1	Risk assessment
6.1.2	Stages of development
6.2	Clearance
6.3	Safeguarding devices
6.3.1	Limiting devices
6.3.1.1	Mechanical limiting devices
6.3.1.2	Nonmechanical limiting devices
6.3.2	Presence-sensing safeguarding devices
6.3.2.1	Component failure
6.3.2.2	Ambient factors
6.3.2.3	Resumption of robot motion
6.3.2.4	Muting

TABLE 28.2 (continued) A Partial List of Items Found in the U.S. ANSI/RIA R15.06 Voluntary Standard

6.3.3	Barrier
6.4	Awareness devices
6.4.1	Perimeter guarding
6.4.2	Awareness barrier
6.4.3	Awareness signal
6.4.3.1	Failure to reach intended location signal
6.5	Safeguarding the teacher
6.6	Safeguarding the operator
6.7	Safeguarding during attended continuous operation
6.8	Safeguarding maintenance and repair personnel
7	Maintenance of robots and robot systems
8	Testing and start-up of robots and robot systems
8.1	Interim safeguarding
8.2	Restricted envelope (space)
8.3	Manufacturers' instructions
8.4	Initial start-up procedure
9	Safety training of personnel
9.1	Training requirements
9.2	Training program content
9.3	Retraining requirements

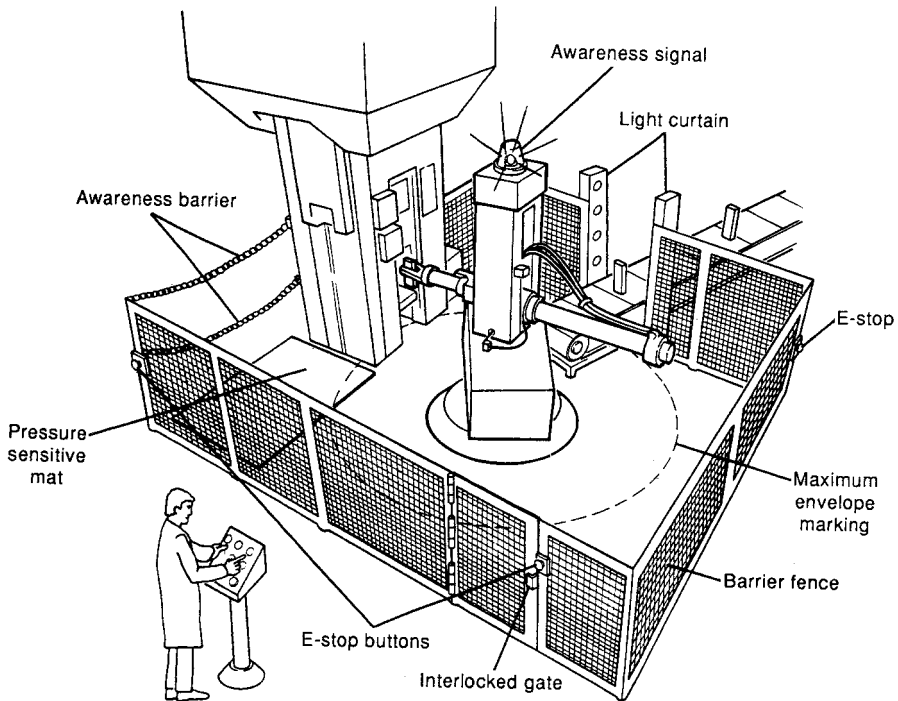

FIGURE 28.1 A schematic of a robotic workstation. This illustration includes a cylindrical robot, a conveyor belt feeding parts to the robot, an associated machine working on the workpiece, an operator with a computer control panel, and a typical array of safeguarding devices for worker protection in all zones of the workstation. (From *American National Standard for Industrial Robots and Robot Systems — Safety Requirements*. ANSI/RIA R15.06-1992, New York. With permission.)

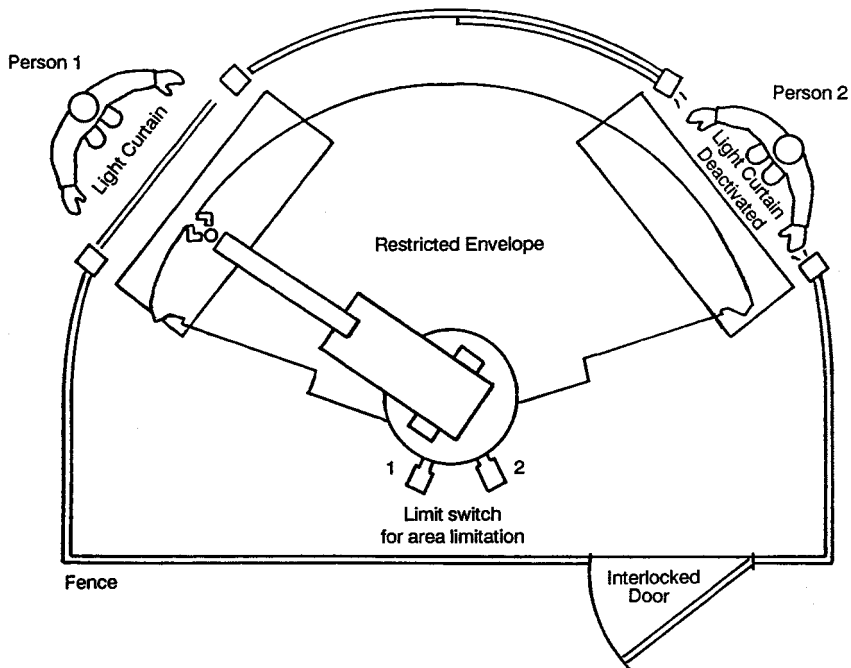

FIGURE 28.2 A schematic of a dynamic restricted human-robot cooperative workstation. The hazards for this cooperative workstation can be reduced by providing a robot controlled two-limit switch assembly. Each limit switch activates a light curtain where the robot arm is moving into for its routine task, while the other limit switch is deactivated allowing the second worker to perform the necessary tasks. (From *American National Standard for Industrial Robots and Robot Systems — Safety Requirements*. ANSI/RIA R15.06-1992, New York. With permission.)

Lockout/tagout: A procedure to ensure that the robot and its associated equipment are stopped, isolated from all potentially hazardous energy sources, and locked out or tagged out before any employees can enter the robot danger zones to perform any servicing or maintenance activities. This procedure is needed to prevent any unexpected energization or start-up of the robot or release of stored energy which could cause injury.

Operating envelope (space): That portion of the restricted envelope (space) that is actually used by the robot while performing its programmed motions.

Pendant: Any portable control device, including teach pendants, that permits an operator to control the robot from within the restricted envelope (space) of the robot.

Perimeter guarding: A rigid fence-like structure that surrounds the restricted envelope (space) of a system of one or more robots and may have entry openings for process equipment, material, and/or personnel authorized to operate or maintain the robot system.

Presence-sensing safeguarding device: A device designed, constructed, and installed to create a sensing field or area to detect an intrusion into such field or area by personnel, robots, or other objects.

Restricted envelope (space): That portion of the maximum envelope to which a robot is restricted by limiting devices. The maximum distance that the robot can travel after the limiting device is actuated defines the boundaries of the restricted envelope (space) of the robot.

Safeguard: A barrier guard, device, or safety procedure designed for the protection of personnel.

Slow speed control: A mode of robot motion control where the velocity of the robot is limited to allow persons sufficient time to either withdraw from hazardous motion or stop the robot.

Teach mode: The control state that allows the generation and storage of positional data points effected by moving the robot arm through a path of intended motions.

User: A company, business, or person who uses robots, or who contracts, hires, or is responsible for the personnel associated with the robot operation.

Other Defining Terms

The following terms are important concepts that are frequently used in other robot safety literature. Due to space limitations, they were not used in this chapter.

Attended continuous operation: The time when robots are performing production tasks at a speed no greater than slow speed through attended program execution.

Automatic mode: The robot state in which automatic operation can be initiated.

Awareness barrier: Physical and visual means that warn a person of an approaching or present hazard.

Control device: Any piece of control hardware providing a means for human intervention in the control of a robot system, such as an emergency stop or a selector switch.

Control program: The inherent set of control instructions that define the capabilities, actions, and responses of the robot system. This program is usually not intended to be modified by the end user.

Limiting switch: A device that restricts the maximum envelope (space) by stopping or causing to stop all robot motion and which is independent of the control program and the application programs.

Muting: The deactivation of a presence-sensing safeguarding device by design during a portion of the robot cycle or during noncyclic activities such as teaching mode.

References

- American National Standards for Industrial Robots and Robot Systems — Safety Requirements.* ANSI/RIA R15.06-1992, American National Standards Institute, New York, NY.
- Backstrom, T. and Harms-Ringdahl, L. 1983. A statistical study on control systems and accidents at work. *Proceedings of the International Seminar on Occupational Accidents*, Stockholm, Sweden, 312-328.
- Brauer, R.L. 1990. *Safety and Health for Engineers.* Van Nostrand Reinhold, New York, NY.
- Giusti, R. and Tucci, M. 1994. Improving active accident prevention in robotized manufacturing plants. *The International Journal of Robotics Research*, 13(4): 334-342.
- International Labor Office, 1989. *Safety in the Use of Industrial Robots.* Occupational Safety and Health Series No. 60, Geneva, Switzerland.
- Karwowski, W. and Rahimi, M. 1991. Worker perception of safe speed and idle condition in simulated monitoring of two industrial robots. *Ergonomics*, 34(5), 531-546.
- McAlinden, J.J. 1995. Using robotics as an occupational health and safety control strategy. *Industrial Robot*, 22(1): 14-17.
- National Institute for Occupational Safety and Health, 1984. *Request for Assistance in Preventing the Injury of Workers by Robots.* Publication No. 85-103, NIOSH Publications Dissemination, DSDTT, Cincinnati, OH: U.S. Government Printing Office.
- Rahimi, M. 1986. System Safety for Robots: An energy barrier analysis. *Journal of Safety Science*. 8: 127-138.
- Rahimi, M. 1995. Hazard identification and control, in *The Engineering Handbook*, Ed. R.C. Dorf, P. 1897-1903. CRC Press, Boca Raton, FL.
- Rahimi, M. and Roland, H.E. 1989. A quantitative fault tree analysis for safety of human-robot interactions. *Proceedings of the 9th International System Safety Conference*, Long Beach, CA, 236-240.
- Robotics World, 1995. News of the Industry, 13(4): 8.
- Seward, D.W., Bradley, D.A., and Margrave, F.W. 1994. Hazard analysis techniques for mobile construction robots, in *Automation and Robotics in Construction XI*, Ed. D.A. Chamberlain, p. 35-42. Elsevier Science B.V., Amsterdam, Netherlands.
- Sugimoto, N. 1987. Subjects and problems of robot safety technology, in *Occupational Health and Safety in Automation and Robotics*, Ed. K. Noro, p. 175-183.

For Further Information

Publications

Proceedings of the Robotic Industries Association: Robot Safety Conference
Proceedings of the British Robot Association Annual Conferences
Proceedings of the International Seminar on Safety in Advanced Manufacturing
Proceedings of the Robots (x) Conference
Proceedings of the System Safety Conference
Proceedings of the Annual Reliability and Maintainability Symposia
Proceedings of the International Conference on Robotics and Factories of the Future
Proceedings of the IEEE International Conference on Robotics and Automation
Proceedings of the Annual Meeting of the Human Factors and Ergonomics Society
Proceedings of the Robot (x) Conference of the Society of Manufacturing Engineers
Proceedings of the International Conference on Human Factors in Manufacturing
Proceedings of the International Conference on Human Aspects of Advanced Manufacturing and Hybrid Automation
Safety, Reliability, and Human Factors in Robotic Systems (Van Nostrand Reinhold)
Human-Robot Interaction (Taylor & Francis)
Robot Safety (Springer-Verlag)
Occupational Health and Safety in Automation and Robotics (Taylor & Francis)
International Encyclopedia of Robotics (Wiley Interscience)
Handbook of Industrial Robotics (John Wiley)
Safety in the Use of Industrial Robots (International Labor Office)
National Safety News
Robotics World
The Industrial Robot
Robotics Today
Professional Safety
Journal of Safety Science
IEEE Transactions on Industry Applications
IEEE Transactions on Automatic Control
The International Journal of Robotics Research
Robotics Engineering
Robotics Age
Plant Maintenance
Plant Engineering
Ergonomics
International Journal of Industrial Ergonomics
Behavior and Information Technology

Organizations

Robotic Industries Association

Subcommittee R15.06 on Safety
 900 Victors Way/P.O. Box 3724
 Ann Arbor, Michigan 48106

Japan Industrial Robot Association (JIRA)

Kikai Shinko Kaikan Building
 3-5-8 Shiba-kown
 Minato-ku
 Tokyo 105, JAPAN

British Robot Association

35-39 High Street
Kempston Bedford MK42 7BT
United Kingdom

Fraunhofer Institute of Manufacturing

Engineering and Automation
Nobelstrasse 12
7000 Stuttgart 80
Germany

29

Ergonomics Issues in Mining

29.1	Introduction.....	29-1
29.2	Epidemiology of Work-Related Musculoskeletal Disorders (WMSDs) in Mining.....	29-2
29.3	Characteristics of the Underground Mining Workforce.....	29-3
	Demographics • Anthropometry • Strength Characteristics of Miners • Aerobic Capacity	
29.4	Demands of Physical Work in Underground Mining.....	29-5
	Daily Energy Expenditure of Miners • Energy Expenditure for Specific Mining Tasks • Effects of Posture on Metabolic Cost • Manual Materials Handling in Restricted Postures • Effects of Restricted Postures on Strength • Psychophysically Acceptable Loads in Restricted Postures • Biomechanics of Restricted Postures • Intra-abdominal Pressure (IAP) • Biomechanical Modeling	
29.5	Summary of Physical Work in Restricted Postures.....	29-10
29.6	Heat Stress.....	29-11
29.7	Equipment and Tool Design.....	29-12
	Mobile Underground Equipment Design Visibility • Whole-Body Vibration • Seating Design • Illumination • Control Design • Maintainability Design • Ergonomics Design Guidelines	
29.8	Hand Tool Design.....	29-17
29.9	Personal Protective Equipment.....	29-17
29.10	Status of Knowledge and Unresolved Issues.....	29-17

Sean Gallagher

*National Institute for Occupational
Safety and Health*

29.1 Introduction

It was not too long ago that coal and ore from underground mines were shoveled or manually loaded onto carts drawn by horse or mule (Sanders and Peay, 1988). As recently as the mid-1950s, almost a third of all coal produced in the U.S. was still hand-loaded. In the years prior to the introduction of mechanization, mining was truly backbreaking work. The principal tools of the miner were the pick and shovel, powered solely by raw muscle. Figure 29.1 illustrates a common task of the underground miner of this period: undercutting a coal face in preparation for blasting. As shown in Figure 29.1, this task was performed while the miner was lying on his side, using a pick to hew the coal and a shovel to support the body. Miners could spend three to six hours undercutting a coal face, using their picks to make a one meter deep horizontal incision at the base of the mineral seam.



FIGURE 29.1 Miners undercutting a coal face prior to mechanization. (From National Archives. With permission.)

Advances in mechanization in the second half of the 20th century have greatly reduced physical demands on the mine worker. Even so, mining remains among the most physically demanding occupations. While the overall magnitude of physical work performed by the miner has been reduced, many unique physical and environmental demands remain. For example, miners may have to deal with restricted workspace, less than desirable illumination, muddy or wet floor conditions, high levels of whole-body vibration, and considerable heavy lifting. Of the stressors listed above, the most demanding environmental characteristic of underground mines is undoubtedly the limited vertical workspace in which many miners must function. The impact of this single factor on human-centered design is extraordinary. The significant injury experience in the mining industry is undoubtedly the consequence of the multiplicity of risk factors present in this environment.

29.2 Epidemiology of Work-Related Musculoskeletal Disorders (WMSDs) in Mining

There is compelling evidence that work-related musculoskeletal disorders (WMSDs) affect mineworkers to a greater degree than workers in other industries (Lockshin et al., 1969). For example, studies have shown that miners experience more disability from knee and back pain (Lawrence, 1955; Lawrence and Aitken-Swan, 1952), more absenteeism (Duthie and Anderson, 1962), more osteoarthritis (Kellgren and Lawrence, 1952; Schlomka et al., 1955), and more disk degeneration (Kellgren and Lawrence, 1952) than comparison industrial populations. Back injuries emerge as a particularly serious problem in mining. A study by Klein et al. (1984) reported that the mining industry had the second highest incidence ratio for back injuries (1.5 claims/100 workers), trailing only the construction industry (1.6 claims/100 workers). Such injuries are consistently the single leading cause of lost-time injuries in U.S. coal mines (Peay, 1983), an experience shared by their international counterparts (Leigh et al., 1991). These injuries typically result from overexertion during the performance of manual materials handling tasks (Peters, 1983).

Manual handling of heavy materials is a pervasive activity in mining, and has been identified as a major contributing factor to sprain and strain injuries (Peay, 1983). The combination of heavy lifting and punishing environmental constraints has been linked to spinal changes in some studies. Lawrence (1955) examined British coal miners to identify factors related to degenerative disk changes, and found that injury, duration of heavy lifting, duration of *stooping*, and exposure to wet mine conditions were

the factors most associated with spinal changes. Another study investigating spinal changes in miners was reported by MacDonald et al. (1984). These investigators used ultrasound to measure the spinal canal diameter of 204 coal miners and found that those with the greatest morbidity had significantly narrower spinal canals. The study by Lawrence (1955) and other evidence suggests that the seam height of the mine has a marked influence on the incidence of low back disorders. In general, compensation claims appear to be highest in seam heights of 0.9 to 1.8 meters (where stooping is prevalent). Claims are slightly lower in seams less than 0.9 meters (where kneeling and crawling predominate), and are substantially reduced when the seam height is greater than 1.8 meters. The finding of increased low back claims in conditions where stooping predominates is in concert with other evidence relating non-neutral trunk postures to low back disorders (Punnett et al., 1991). It is not surprising, given the physical demands and environmental constraints, that a field survey performed by the National Institute for Occupational Safety and Health (NIOSH) found that exposure to ergonomic hazards for miners was high compared to nonmining industries (Winn and Biersner, 1992).

While back injuries are more frequent in mining than in other industries, upper extremity CTDs do not appear as severe. This should not be too surprising since mining does not typically require highly repetitive or forceful exertions by the hands. As a result, the incidence rate of carpal tunnel syndrome is relatively small in mining (Hudock and Keran, 1992); however, it must be noted that a steady increase in the number of reported cases has been observed in recent years (MSHA, 1991). It is not clear whether this increase is due to changes in workplace factors (i.e., increasing use of remote controls or repetitive exertions in roof bolter's tasks), or is a reporting artifact resulting from increased media attention given the disorder during this period.

29.3 Characteristics of the Underground Mining Workforce

Demographics

In 1986, the U.S. Bureau of Mines conducted a probability sample survey, the Mining Industry Population Survey (MIPS), to assess demographic characteristics of the United States mining workforces (Butani and Bartholomew, 1988a, 1988b). While the MIPS is by now somewhat dated, it remains our most recent look at the U.S. mining population, and contains several notable demographic findings. One finding that stands out is the almost exclusive dominance of male workers in the coal mining workforce. Ninety-eight percent of the coal workforce is male, and of the 2% that are female, only half work underground. Almost as dramatic is the dominance of Caucasians, comprising 94% of the total coal workforce. The cultural makeup of metal and nonmetal mines was a bit more varied, with whites, blacks, and Hispanics representing 82, 7, and 8% of the workforce, respectively. The difference in cultural makeup between coal and metal/nonmetal mines may be largely the result of the geographic location of the various types of mines. At the time of the survey, the average age of the coal workforce was 39; however, recent anecdotal evidence suggests that the mean age of the coal miners is now well into the 40s. Thus, ergonomics researchers and industry committees must consider the physical and cognitive effects of an aging workforce when carrying out ergonomics interventions.

Anthropometry

Physical characteristics of the underground mining population have been reported by several authors (Moss, 1934; Gary et al., 1955; Humphreys and Lind 1962, Ayoub et al., 1981b; Ayoub et al. 1984; Gallagher and Hamrick, 1992). By far the most in-depth studies (in terms of measures taken and sample size) are those by Ayoub and colleagues (Ayoub et al., 1981; Ayoub et al. 1984). These authors collected a battery of 42 anthropometric measurements for two major segments of the mining population: (1) low coal miners, and (2) non-low coal miners. Data for each of these populations were compared with those of other occupational groups to detect whether significant differences were evident. Comparison of the anthropometry of low coal miners vs. comparison industrial groups showed that miners were heavier,

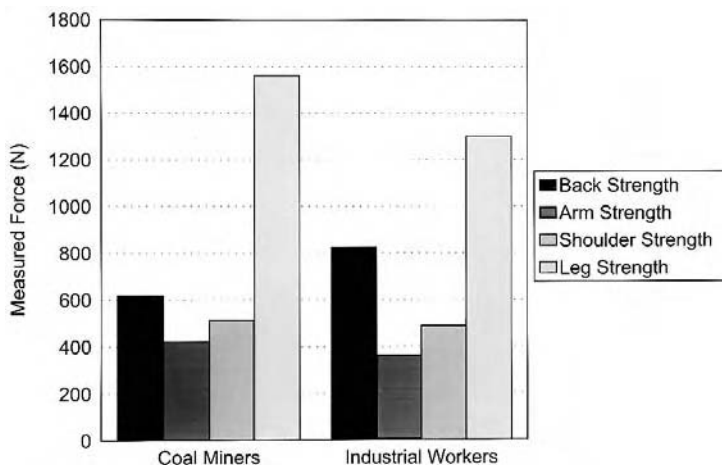

FIGURE 29.2 Comparison of strength measurements between low-seam coal miners and a traditional industrial population. (From Ayoub, M. M., Bethea, N. J., Bobo, M., Burford, C. L., Caddel, K., Intaranont, K., Morrissey, S., and Selan, J. 1981a. *Mining in Low Coal. Volume 1: Biomechanics and Work Physiology*. Final Report — U.S. Bureau of Mines Contract No. HO3087022. Texas Tech University, Lubbock, TX.)

and exhibited a related increase in the circumferences of the torso, arms, and legs (Ayoub et al., 1981b). Male low coal miners were also somewhat heavier than miners not working in low coal; however, the opposite trend was observed with female miners. Females working in non-low coal were also larger in all measures of circumference. This difference may be attributed to tasks performed, and varied geographical and ethnic makeups of the two groups.

Strength Characteristics of Miners

Various measures of isometric strength of underground miners were also obtained by Ayoub et al. (1981a) and Ayoub et al. (1984). These included back strength, shoulder strength, arm strength, sitting leg strength and standing leg strength. When compared with a sample of industrial workers (Ayoub et al., 1978), low-seam coal miners were found to have significantly lower back strength, but much higher leg strength (Figure 29.2). The authors ascribed the decrease in back strength to unspecified factors related to the postures imposed by the low-seam environment. Indeed, there is evidence to support this position. Low coal miners may be obliged to work in a stooping posture for extended periods. In this posture, the spine is largely supported by ligaments and other passive tissues, “sparing” the use of the back muscles. Studies of lifting in the stooping posture suggest that the gluteal muscles and hamstrings provide a large share of the forces in this position (Gallagher et al., 1988). The results of Ayoub et al. (1981a) may be due to a relative deconditioning of back muscles when stooping (due to relative inaction), and an increased reliance on the leg and hip musculature to perform underground work tasks (producing an increase in leg strength).

Aerobic Capacity

Several studies have investigated the maximal aerobic power of underground miners, using estimation techniques (Ayoub et al., 1981; Ayoub et al., 1984) or direct measurement (Kamon and Bernard, 1975; Kamon, Doyle, and Kovac, 1983). Most studies appear to agree that underground miners are inclined to have lower than average aerobic capacity compared with population norms and to comparison groups. The trend is evident for both genders (Ayoub et al., 1981a; Ayoub et al., 1984), and might be related to the finding, reported above, that underground miners exhibit increased body weight when compared with other groups. Kamon and Bernard (1975) found a steeper drop in maximal oxygen uptake and

heart rate with age in miners than in other published data. However, it should be noted that other data have not shown as steep a decline (Ayoub et al., 1984).

29.4 Demands of Physical Work in Underground Mining

Imagine arriving at work one day to find that the ceiling of your workplace had been inexplicably lowered to 120 cm (approximately 4 ft.) above the floor. The impact of this restriction in workspace on the ability to perform normal work functions becomes immediately apparent. What once were routine tasks (for example, simply walking down the hall) suddenly become enormously demanding. Instead of walking erect, one is forced to walk fully bent over at the waist. Imagine further that part of your job for the day required considerable manual handling of heavy materials, for example, lifting or carrying 23-kg bags from one end of the hall to the other. As this scenario is contemplated, one can begin to get a picture of the unique physical demands that are present in the coal mining environment. As difficult as it may be to believe, the environmental restrictions described above might seem luxurious to some miners. Occasionally, miners perform physical work in vertical space restrictions so severe that crawling is not even possible. While this represents an extreme case, it is not at all uncommon for the mine to be no higher than 1.2 meters. In fact, about half of all coal mines in the U.S. fit this category. As will be discussed in this section, the physiological and biomechanical demands of doing manual work in such an environment are much greater than if this constraint were not present.

Daily Energy Expenditure of Miners

Before mechanization, the energy expenditure of underground coal miners remained relatively high throughout the workday. A study by Moss (1934) showed that the average daily energy expenditure for a coal miner before mechanization was approximately 4500 kilocalories per day. Rest periods were not of sufficient length to bring the oxygen consumption back down to a normal resting level. Modern mining, on the other hand, is characterized by short bursts of high energy expenditure tasks, interspersed with periods of rest or lower energy tasks. Figure 29.3 illustrates the ventilation volume and oxygen uptake for a roof bolter helper in a low-seam environment (Ayoub et al. 1981a). As can be seen in this figure, the roof bolting cycle contains periods where the energy expenditure is greater than 2 liters/min, and other periods where recovery is possible. The introduction of more frequent rest breaks from increased mining mechanization appears to be reflected in the reduction in shift energy expenditure of the coal miner. Depending on the specific job title of the miner, shift energy expenditures for miners in the late 1970s were found to range between 2100 and 2800 kcals (Ayoub et al., 1981a). However, it should be noted that these values are still at or above proposed maximum permissible limits for daily energy output for men (Banister and Brown, 1968; NIOSH, 1981).

Energy Expenditure for Specific Mining Tasks

Several studies have examined the energy expenditure of performing specific underground mining tasks (Ayoub et al., 1981a; Ayoub et al., 1984; Durnin and Passmore, 1967; Moss, 1934; Gary et al., 1955). Table 29.1 provides a summary of energy expenditure data for mining tasks from these sources. As can be seen from this table, many mining tasks fit into the category of heavy work (5.0 to 7.5 kcals/min), or very heavy work (7.5 to 10.0 kcals/min), based on the classification suggested by Astrand and Rodahl (1977). The table presented here is not exhaustive. Additional data on energy expenditure requirements for mining tasks are available (Durnin and Passmore, 1967; Ayoub et al., 1984).

Effects of Posture on Metabolic Cost

The posture adopted in the performance of a work task has a decided influence on the metabolic demands incurred by an individual. Nowhere is this more evident than in the evaluation of metabolic demands of working in constricted mining workspace (Moss, 1934; Bedford and Warner, 1955; Humphreys and

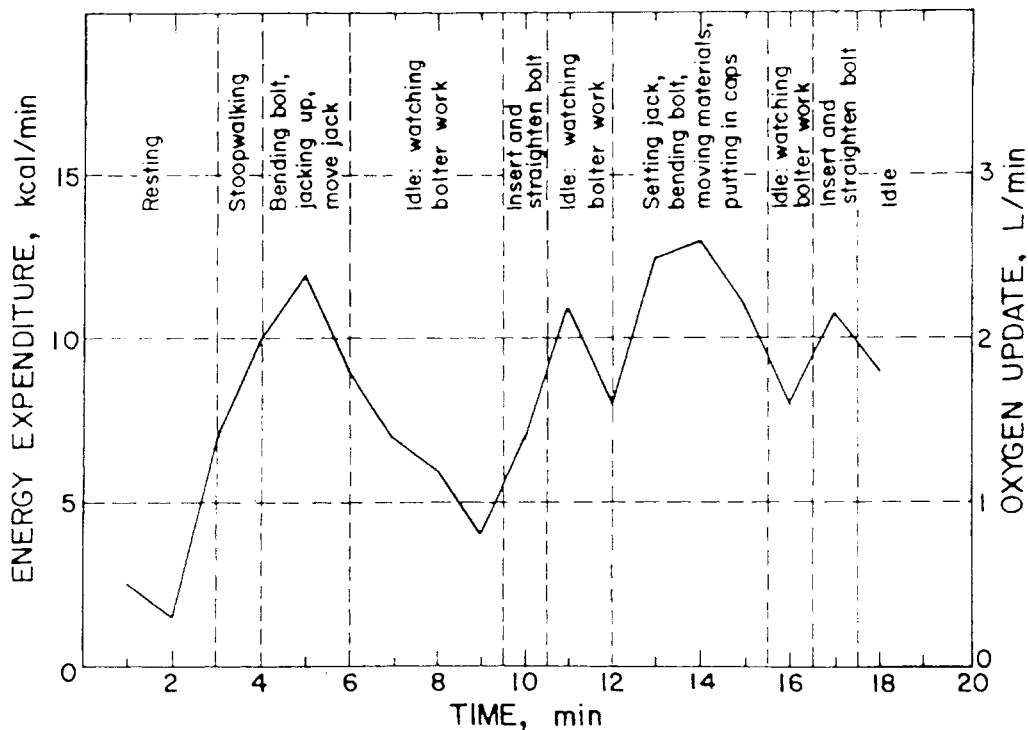

FIGURE 29.3 Energy expenditure and activity profile for a roof bolter helper. (From Ayoub, M. M., Bethea, N. J., Bobo, M., Burford, C. L., Caddel, K., Intaranont, K., Morrissey, S., and Selan, J. 1981a. *Mining in Low Coal. Volume 1: Biomechanics and Work Physiology*. Final Report — U.S. Bureau of Mines Contract No. HO3087022. Texas Tech University, Lubbock, TX.)

TABLE 29.1 Energy Expenditure for Selected Mining Tasks

Activity	Mean Energy Expenditure (kcal/min)	Standard Deviation	Range
Shoveling Coal			
Durnin and Passmore (1967)	7.0	—	5.1–9.4
Ayoub et al. (1981)	9.3	3.0	—
Garry et al. (1955)	6.9	0.9	—
Erecting Roof Supports	5.7	—	4.2–10.1
Helping			
Low Coal (Ayoub et al., 1981)	7.2	1.7	—
Non-Low Coal (Ayoub et al., 1984)	5.7	2.1	—
Roof Bolting			
Low Coal (Ayoub et al., 1981)	4.9	1.5	—
Non-Low Coal (Ayoub et al., 1984)	5.6	1.5	—
Timbering			
Ayoub et al. (1981)	6.0	2.4	—
Garry et al. (1955)	5.7	1.5	—
Humphreys and Lind (1952)	6.0	—	—
Scaling Roof (Ayoub et al., 1984)	8.5	—	—
Rock Dusting (Ayoub et al., 1984)	7.6	—	—
Moving Cables (Ayoub et al., 1984)	7.1	—	—
Jackleg Drilling (Ayoub et al., 1984)	7.1	—	—
Machine Maintenance (Ayoub et al., 1984)	6.2	—	—
Track Maintenance (Ayoub et al., 1984)	7.2	—	—

TABLE 29.2 Physiological Cost of Erect Walking, Stoopwalking, and Crawling

Task	Sex	Heart rate (beats/min)	Ventilation volume (L/min)	Percent work capacity	Oxygen uptake (ml × kg ⁻¹ × min ⁻¹)
Normal Walk	Male	89.2 (5.4)	10.6 (0.4)	10.9 (0.9)	5.0 (0.9)
	Female	89.7 (3.6)	9.6 (0.7)	11.6 (2.2)	4.4 (0.6)
90% Stoopwalk	Male	96.0 (9.3)	12.8 (0.9)	12.5 (2.0)	5.7 (1.4)
	Female	107.5 (6.8)	12.4 (1.8)	15.3 (2.9)	5.8 (0.4)
80% Stoopwalk	Male	86.8 (15.8)	13.9 (1.8)	14.7 (2.3)	6.8 (1.5)
	Female	92.0 (12.7)	12.0 (0.6)	15.2 (2.2)	5.8 (0.2)
70% Stoopwalk	Male	82.2 (7.2)	13.2 (1.7)	15.1 (4.1)	6.8 (1.5)
	Female	89.9 (11.1)	11.0 (1.2)	15.7 (3.5)	6.0 (1.0)
60% Stoopwalk	Male	88.5 (7.2)	17.0 (2.3)	18.1 (1.4)	8.3 (1.0)
	Female	100.5 (21.6)	16.2 (5.3)	21.3 (5.0)	8.1 (1.8)
Crawling	Male	81.3 (11.3)	12.5 (1.3)	15.5 (2.3)	7.0 (0.5)
	Female	87.4 (7.8)	10.3 (1.0)	14.8 (2.7)	5.7 (1.8)

Numbers in parentheses represent the standard deviation.

Source: Ayoub, M. M., Bethea, N. J., Bobo, M., Burford, C. L., Caddel, K., Intaranont, K., Morrissey, S., and Selan, J. 1981a. *Mining in Low Coal. Volume 1: Biomechanics and Work Physiology*. Final Report — U.S. Bureau of Mines Contract No. HO3087022. Texas Tech University, Lubbock, TX.

Lind, 1962; Ayoub et al., 1981; Morrissey et al., 1985). Moss (1934) examined the physiological cost associated with normal walking, a “half-stoop” (80% of full stature), a “full-stoop” (60% of full stature), and walking on “all-fours” (50% of full stature) for eight experienced mining subjects. His finding showed that the half-stoop, full-stoop, and all-fours conditions increased the metabolic demands of walking 3.5 mph by 21, 65, and 73%, respectively. Similar trends were shown by Humphreys and Lind (1962), while the data from Bedford and Warner (1955) showed much higher increases in metabolic cost with *stoopwalking*. The most thorough experiment of the effects of stoopwalking and crawling was done by Ayoub et al. (1981a) and also reported by Morrissey et al. (1985). This study illustrated a progressive trend toward increasing metabolic cost as stooping becomes more severe (Table 29.2). Not only is the metabolic cost increased as stooping becomes more severe, the maximum speed attainable by subjects is reduced, particularly in stoopwalking at 60% stature and in crawling tests.

The metabolic cost of manual materials handling in restricted postures (stooping and kneeling) has also been studied (Gallagher and Bobick, 1988; Gallagher et al., 1988; Gallagher and Unger, 1990; Gallagher, 1991; Freivalds and Bise, 1991; Gallagher and Hamrick, 1992). These studies suggest that the metabolic cost of manual materials handling is not predominantly influenced by posture, but by an interaction between the posture adopted and the task being performed. For example, the kneeling posture is more costly than stooping when a lateral transfer of materials is done (Gallagher and Bobick, 1988; Gallagher et al., 1988; Gallagher and Unger, 1990). However, other studies have illustrated that kneeling can be more economical when the task requires increased vertical load displacement (Gallagher, 1991; Freivalds and Bise, 1991; Gallagher and Hamrick, 1992). A study of shoveling tasks in different postures by Morrissey et al. (1983) found no difference in energy expenditure in standing, stooping, and kneeling postures; however, only five subjects participated in this study and it may suffer from a lack of sufficient power to detect differences.

Manual Materials Handling in Restricted Postures

Mining is essentially an exercise in materials handling, some of which has been automated (especially the revenue-producing mineral extraction and transport segment), but much of which has not (movement of mining supplies, maintenance work, etc.). The amount of manual work that must be done in underground mines would be demanding enough without imposing restrictions in vertical workspace. As discussed below, such restrictions influence human strength capabilities, psychophysically acceptable workloads, and lifting biomechanics.

Effects of Restricted Postures on Strength

Studies examining static or dynamic strength capabilities in unusual or restricted postures are relatively rare. Haselgrave et al. (1987) reported results of isometric strength tests in kneeling vs. standing postures. These authors reported that lateral exertions were weaker when kneeling; however, pushing forces were equivalent in both postures. Pulling and lifting forces in the kneeling posture exceeded those in the standing position, by 25 and 44%, respectively. Results obtained by Gallagher (1989) were similar; however, this author reported higher pushing forces when kneeling on two knees than when standing. This study also studied a maximum upward push (with the force exerted upon a lifting handle at eye height), for which strength was not dependent on posture.

A study by Gallagher (1997) investigated trunk extension strength and electromyography of eight trunk muscles in standing and kneeling postures. Findings of this study showed that trunk extension strength is reduced by 16% in the kneeling posture in comparison with standing. However, normalized trunk muscle EMG was not significantly different between the two postures. Gallagher (1997) speculated that the reduction in trunk extension strength in the kneeling posture may be the result of a reduced capability to perform a strong rotation of the pelvis when the kneeling posture is adopted.

Psychophysically Acceptable Loads in Restricted Postures

Several studies of psychophysical lifting capacity in restricted postures have been done. Ayoub et al. (1987) reported psychophysical limits for a variety of unusual lifting postures including kneeling, sitting, lying down, and others. These data were collected with the assumption that atypical postures would be used only infrequently, for example, a one-time lift. Unfortunately, such postures may be used by miners for more prolonged bouts of manual lifting. As a result, the U.S. Bureau of Mines has examined the lifting capacity of underground miners in a variety of postures and vertical space constraints for tasks of longer duration (Gallagher et al., 1988; Gallagher and Unger, 1990; Gallagher, 1991; Gallagher and Hamrick, 1992). These investigators particularly wanted to quantify lifting capacity in the two most common postures used for lifting in *low-seam mines* — stooping and kneeling on both knees (Bobick, 1987). Results of these studies showed a significant decrease in lifting capacity in the kneeling posture, ranging from 8 to 18% (Gallagher et al., 1988; Gallagher and Unger, 1990; Gallagher, 1991; Gallagher and Hamrick, 1992). This deficit may be due to restrictions in the forces provided by the powerful hip and leg musculature in the kneeling posture, as compared with standing or stooping. In the stooping posture, the hamstrings and gluteal muscles appeared to provide a great deal of the force for the lifting tasks. Subjects consistently identified these muscle groups as those most sore after periods of lifting in the stooping posture (Gallagher et al., 1988). However, the effects of posture can be overridden by other MMH variables. For example, lack of a good handhold may reduce the acceptable load to a point that the differences related to posture are no longer evident (Gallagher and Hamrick, 1992).

A surprising, and somewhat disturbing, result of these studies is that psychophysically acceptable loads in prolonged stooping were generally on par with that achieved in the unencumbered standing position (Gallagher and Hamrick, 1992). Given the association of trunk flexion and incidence of low back disorders (Punnett et al., 1991), one would envision reduced load acceptability in this posture. However, as Snook (1985) has noted previously, the psychophysical approach does not seem sensitive to bending and twisting motions often associated with low back pain. Results of psychophysical studies in restricted postures seem to confirm this assessment. Further, these studies raise the issue of what drives subjective assessments of acceptable loads. Such assessments might be largely based on strength capabilities and physiological workload, rather than responses to the strain experienced by the low back. It may be advisable to base lifting limits for the stooping posture on biomechanical parameters, rather than relying on psychophysical estimates.

Biomechanics of Restricted Postures

Several methodologies have been employed to evaluate the biomechanical strain experienced during manual work in restricted postures. These have included use of intra-abdominal pressure (IAP),

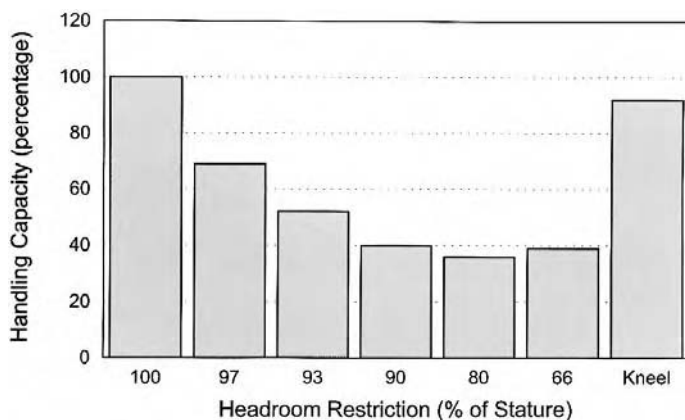

FIGURE 29.4 Handling capacity for stooping (percentages of full stature) and kneeling postures according to the IAP criterion. (From Ridd, J.E. 1985. Spatial restraints and intra-abdominal pressure. *Ergonomics*, 28(1): 149-166. With permission.)

electromyography (EMG), and estimations of L_5 - S_1 moments. Because of their unique features, the restricted postures employed in underground mining have been found to present challenges to many traditional biomechanical models. As discussed in the following sections, there are often serious concerns whether certain ergonomic models are valid tools for the analysis of atypical postures.

Intra-abdominal Pressure (IAP)

Evaluation of spinal loading using the IAP criterion has been described by several authors (Davis and Troup, 1966; Davis and Ridd, 1981; Ridd, 1985; Sims and Graveling, 1988). Ridd (1985) found an almost linear decrement in lifting capacity with progressively lower vertical workspace up to 90% of stature, after which the decrement began to level off (Figure 29.4). At standing positions ranging from 66 to 90% of stature, the decrease in lifting capacity was 60%, according to the IAP criterion. The kneeling posture was found to incur only an 8% decrease in lifting capacity where the space restriction was equivalent to 75% of stature, according to Davis and Ridd (1981). Ridd (1985) also described the effects of asymmetric lifting activities on IAP. There was some indication that lifting asymmetrically is less stressful than sagittal plane activities in restricted postures. This result is in accord with psychophysical data showing that subjects were willing to accept greater loads asymmetrically in restricted postures (Gallagher, 1991). The reason may be that sagittal plane motions are precisely those most inhibited by vertical space constraints. Asymmetric motions are less affected by this restriction, leading to increased lifting capacity and decreased IAP responses.

There is currently much controversy regarding the role of IAP in spinal biomechanics. The original belief that IAP reduces the compressive loading on the lumbar spine has been disputed recently by many authors (Grillner et al., 1978; McGill and Norman, 1985; Nachemson et al., 1986). A particular concern is that the increase in IAP requires higher abdominal muscle activity, resulting in an additional compression penalty on the lumbar spine. Furthermore, the IAP does not always appear to respond to situations where spinal loading is known to be high, for example, when the spine is loaded asymmetrically (Andersson, 1982). In fact, IAP does not always produce consistent results with flexed postures (Sims and Graveling, 1988). At any rate, our understanding of the role of IAP in spinal biomechanics seems far from complete. As a result, some have recommended caution in using this mechanism to establish safe handling limits (Andersson, 1982; Ayoub and Mital, 1989).

Biomechanical Modeling

As mentioned previously, the robustness of many traditional biomechanical models may be put to the test in the analysis of atypical postures. As an example, while the spinal muscles provide the majority of

lumbar support when the trunk is erect or moderately flexed, the spine employs a distinct “passive” mechanism of support when the trunk is fully flexed (Floyd and Silver, 1951; Floyd and Silver, 1955; Silver, 1954). While progress has been made in our understanding of this passive loading in recent years (Dolan et al., 1994), there remains a great deal to learn about this spinal support mechanism. Similarly, the kneeling posture is atypical of the type of lifting posture for which many biomechanical models have been formulated, most of which assume the feet constitute the base of support. Adopting a kneeling position changes a great deal regarding lifting biomechanics, for example, reducing leg muscle contributions to the lift. This may result in an increased agonist role for the erectors spinae.

An analysis reported by Gallagher and Unger (1988) illustrates some typical problems encountered with use of traditional biomechanical models in the analysis of restricted postures. These authors used the optimization model developed by Schultz and Andersson (1981) to estimate the compressive and shear loading in stooping and kneeling positions. The validity of this model in restricted postures was suspect, as model estimates of muscle forces contradicted EMG responses in the two postures. The analysis done in this study was admittedly beyond the scope of the validation performed by Schultz et al. (1982), where the most severe trunk flexion angle was 30 degrees. However, this example points out the problems run into repeatedly by the author. Many models available simply have not been validated for the analysis of unusual or atypical lifting postures.

Similar problems exist with the use of EMG-assisted biomechanical models with restricted postures (Gallagher et al., 1994). EMG-assisted models are greatly advancing our knowledge of trunk muscle responses and loading on the lumbar spine to manual materials handling activities (Marras and Sommerich, 1991a; Marras and Sommerich, 1991b). However, such models are generally valid under conditions where trunk muscles are the structures called upon to provide a restorative moment. However, the reliance on passive mechanisms (as opposed to muscles) in the stooping posture makes it less amenable to such an approach. Use of an EMG-assisted model to evaluate restricted postures has uncovered complex muscle recruitment patterns (Gallagher et al., 1994); however, the issue of the passive component, estimated to account for 16 to 31% of the extensor moment in full flexion (Dolan et al., 1994) still needs to be resolved when using EMG-assisted models in the stooping posture.

A recent study of the mining task of handling heavy electrical cables examined the estimated peak L5-S1 moments resulting from hanging the cable under a variety of postures and vertical space limitations (Gallagher et al., 1995). The major finding of this study was that the peak moment when hanging cable was more highly related to the restriction in vertical space than to the posture employed. As can be seen in Figure 29.5, the greater the restriction in vertical space, the higher the peak moment experienced by the subject. It should be noted that this trend is evident even in the face of a contrary trend. That is to say, the higher the cable is lifted off the ground, the more weight is handled. Thus, lower moments were experienced with greater vertical space, though more weight was lifted under these conditions. Contrasts examining differences in peak moment in stooping and kneeling postures showed no difference in peak loading between these postures.

29.5 Summary of Physical Work in Restricted Postures

From the literature reviewed above, we can begin to develop an understanding of the stresses associated with working in restricted postures. Clearly, working in such postures exacts many tolls, including increased metabolic demands, decreased lifting capacity, and increased loading on the lumbar spine. What should also be clear, however, are some limitations of the parameters that we rely upon to provide insight regarding physical capabilities of workers. As discussed above, some of our parameters may disagree about which posture has the greatest limitation in handling capacity. If one were to look only at IAP data, we would conclude that handling capacity is only slightly reduced when kneeling. A different conclusion is reached when the psychophysical approach is used. Similarly, examination of the stooping posture using psychophysics may not suggest a deficit in acceptable workloads compared with standing, whereas biomechanical measures display increased strain on the low back. Clearly, reliance on only one measure or technique may not be sufficient to develop a full appreciation of the capabilities and/or

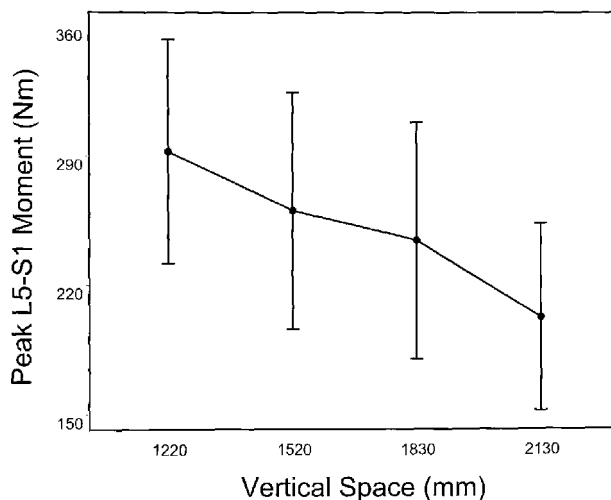

FIGURE 29.5 Relationship between vertical space restrictions and peak moment experienced during a cable hanging task. (From Gallagher, S., Hamrick, C.A., Cornelius, K., and Redfern, M. 1995. "Peak L5-S1 Moments Associated with a Cable Hanging Task," Poster Presentation at the 39th Annual Meeting of the Human Factors and Ergonomics Society Conference, San Diego, CA, October 9-13 1995.)

limitations associated with a particular working position. Examining a variety of measures, on the other hand, appears to help develop a better understanding of the multivariate stressors that workers experience, and may also point out the strengths and limitations of our own analysis techniques.

29.6 Heat Stress

Mining has long figured prominently among occupations routinely exposed to high heat stress (Martinson, 1977). This is particularly true for *deep mines* (for example, South African gold mines), mines sunk in hot countries, or in mines situated along zones where high heat flow from the earth occurs (Misaqi, 1991). Medical experts recognize that exposure to hot, humid conditions is both unhealthy and unproductive. Figure 29.6 illustrates the decreasing productivity of mineworkers loading mine cars and drilling rock as the ambient temperature is increased. Of course, many serious health problems are associated with heat exposure, including heat cramps, heat exhaustion, and heat stroke. The latter condition can often lead to death. However, heat stress can also have a significant impact on safety even below levels that may cause actual physical harm (Hancock and Vercruyssen, 1988). With even moderate heat exposure, workers may ignore unsafe working conditions, have decreased dexterity, coordination and cognitive ability, and are more apt to act emotionally. This may lead to rash acts by people performing hazardous jobs.

A great deal of our knowledge of the effects of heat stress, and on methods to control these effects, may be credited to the Human Sciences Laboratory of the Chamber of Mines of South Africa (Wyndham et al., 1973). In the 1920s, as the gold mines in the Witwatersrand were sunk to depths greater than 1800 meters, virgin rock temperatures continued to climb, and the ambient wet bulb temperatures in the mine began to exceed 30 degrees C. Heat stroke became an alarming problem; in 1930 alone, 27 deaths from heat stroke occurred. This rash of deaths prompted an intensive period of research, resulting in several control measures to protect mineworkers against the adverse effects of physical work in high heat and humidity conditions. These included better acclimatization to heat, recognition of heat intolerant individuals, definition of safe heat stress limits, and adaptation of microclimate cooling systems for use in the gold mining industry. Of these, the most important advances were in the field of heat acclimatization (Strydom, 1966). Initially, the acclimatization regimen was accomplished over a 12- to 14-day period by exposing miners to cooler production areas of the mine and progressing them to the hotter production

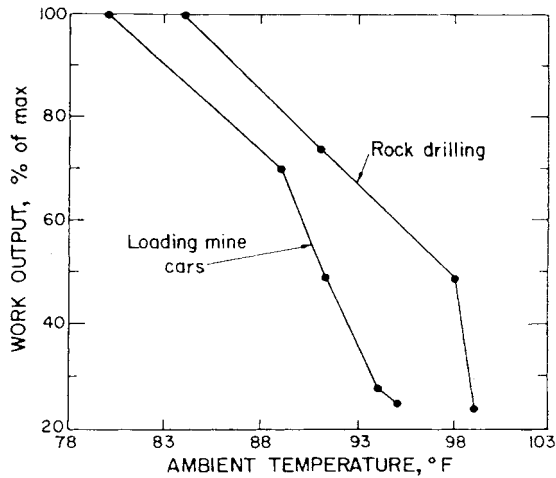

FIGURE 29.6 Effects of ambient temperature on miners' capacity to load mine cars and drill rock. (From Misaqi, F. L. 1984. *Heat Stress in Mining*. Safety Pamphlet No. 6, Mine Safety and Health Administration, Beckley, WV.)

areas. However, the laboratory continued to refine the procedure and ultimately initiated an 8-day regimen where workers were acclimatized by bench-stepping at a workload of 1 liter O₂/min in environmental chambers set at a wet bulb temperature of 32° C. This procedure has been very successful in controlling the incidence of heat-related illnesses.

29.7 Equipment and Tool Design

Environmental conditions in underground mines not only affect the physical capabilities of underground workers, they also have a profound impact on the design of underground equipment and tools. For example, the restricted spaces in coal mines present a huge challenge for developing appropriately designed operator compartments and/or workstations. Underground mobile equipment may be so low profile that operators must lie completely down on their sides or back to operate the machine. This presents extreme problems for visibility and operator fatigue. Furthermore, mobile underground equipment may not have sufficient vertical space to provide systems for shock absorption, leading to serious whole-body vibration exposure. Add to this the problems of seating in mobile underground equipment. Often, seating consists of a steel seat welded to the frame of the vehicle. Illumination is also a critical design issue in underground mines, which are wholly dependent on artificial lighting systems. Other issues of concern include the design of hand tools and personal protective equipment used by miners.

Mobile Underground Equipment Design

Development of ergonomically designed operator compartments and workstations for underground mining equipment is an imposing task. The interaction of the confined space of the mine and the massive equipment required to mine the coal often results in operator compartments cramped and poorly designed. It is common to find operator compartments less than 76 cm in height and less than 61 cm wide. Visibility is almost inevitably influenced by the cramped conditions, often requiring the operator to lean out of the cab, which may expose him to hazards. Illumination systems in these confined spaces often cause the operator to be exposed to disability glare, further restricting visibility. In many cases, controls are designed and/or placed awkwardly. This increases the chance that controls may be improperly activated (or not activated at all) in emergencies. This is clearly a recipe for disaster (Conway and Unger, 1988). Fortunately, a great deal of international attention has been focused on the ergonomics of operator compartment and workstation design during the last 25 years. Major findings of this research are reported below.

Visibility

In the early 1980s, the U.S. Bureau of Mines sponsored research to learn critical visibility requirements for three common varieties of mobile underground equipment: shuttle cars, continuous miners, and scoops (Sanders and Kelley, 1981). Structured interviews and task analytic procedures were employed to evaluate the required visual information to perform tasks such as loading, hauling, or dumping. From this analysis, specific points were identified that must be visible to satisfy visibility requirements. These points, called visual attention locations (or VALs), were defined with reference to generic machine locations. For example, machine operators must be able to view a point on the ground sufficiently far away to stop their vehicle to avoid collision. The results of this VAL research have recently been incorporated into a computerized analysis package. Visibility analysis is automated to determine, for example, the relative visibility rating for a 5th percentile female or a 95th percentile male operator. This allows the designer easily to manipulate and optimize the visibility design of the operator's compartment, without the need to build expensive and time-consuming mockups.

Whole-Body Vibration

A study of mobile underground equipment operators in the early 1980s indicated that between 33 and 39% of operators are exposed to levels of whole-body vibration exceeding the ISO fatigue-decreased proficiency level (Remington et al., 1984). Between 7 and 14% were exposed to levels exceeding the ISO exposure limit. Other tests have been reported that miners may experience nearly 35% of the ISO 8-hour exposure limit simply riding for the 30 minutes it takes to get to the working face of the mine (Love et al., 1992). The effects of whole-body vibration have been studied in several Bureau of Mines experiments. A study by Bobick et al. (1988) examined the effects of 30 minutes of random whole-body vibration typical of a mine haulage vehicle on several measures, including back strength, dexterity, stature, heart rate, blood pressure, and subjective discomfort. Vibration was found to increase HR and BP, and discomfort ratings, but had no influence on back strength, stature, or dexterity. A subsequent study (Bobick et al., 1989) showed no compromise of back muscle strength or endurance related to short-term vibration exposure. These authors suggest that the lack of effect on back strength suggests that the low back pain associated with whole-body vibration may depend on postural and mechanical effects rather than any change in the function of the back musculature. The effects of WBV exposure on postural stability have also been investigated (Cornelius et al., 1994). Balance seemed unaffected by short-term exposure to whole-body vibration.

Seating Design

There is an increasing awareness in the mining industry of the importance of providing appropriate seating for operators of underground mobile equipment. This is no doubt due to the sequelae of exposure to whole-body vibration. While this awareness is slowly infiltrating the industry, many seating designs for underground equipment currently remain relatively primitive. In fact, even some of the latest mining equipment provides only a bent steel plate bolted to the machine frame as the only means of operator support (Love et al., 1992). When this situation is combined with the inability to provide shock absorption systems (again, due to lack of sufficient clearance to dissipate the energy), the effects should become apparent. The restricted headroom in many underground mines provides additional challenges for the equipment designer. In very low mines, equipment operators may have to lie down to run mobile equipment. When conditions are not quite as severe, the operator may have to assume a reclining position that affects visibility. Given the problems enumerated above, it is not surprising that past attempts at improving seating by equipment manufacturers have not met with a great deal of success.

The goals for seating design in underground mobile equipment are similar to those in other applications: provide a stable position from which to control the machine, provide some isolation from vibration and jolting, and reduce the risk of postural fatigue (McPhee, 1993; Collier et al., 1986). There have been guidelines put forth for the design of seating in underground equipment for various seam heights (Collier

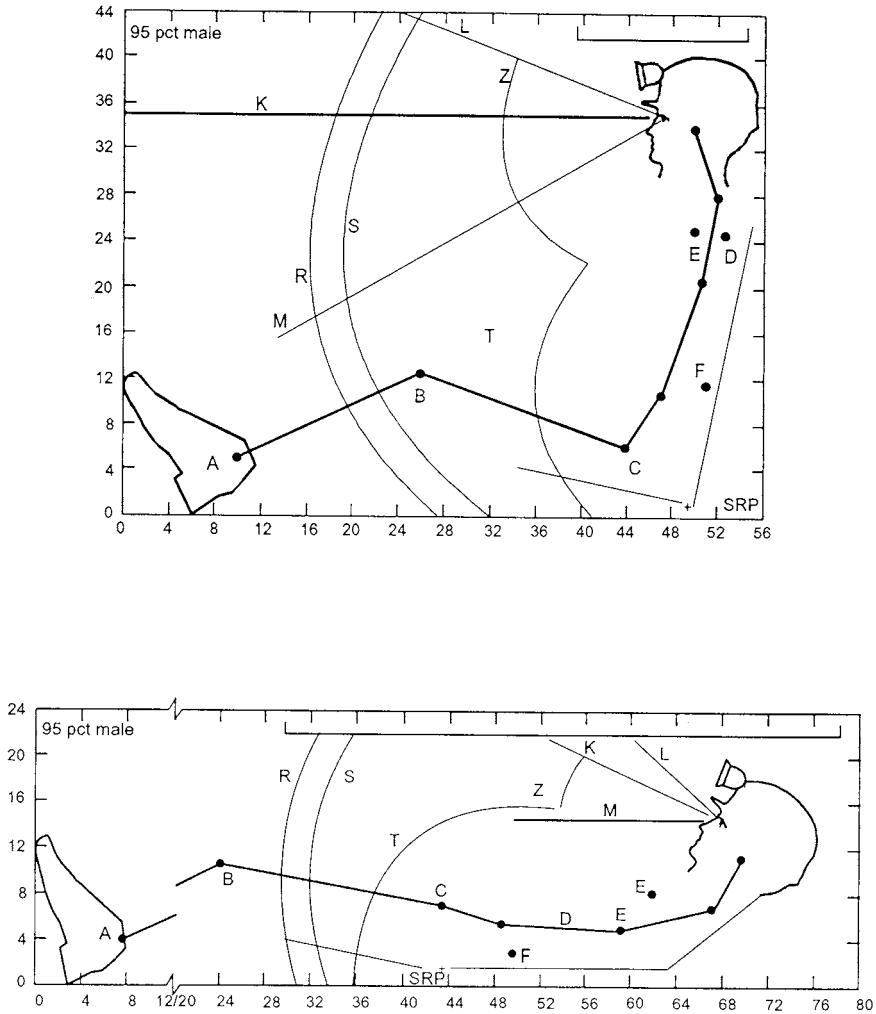

FIGURE 29.7 Seating space envelopes for 95th percentile miners in 107 cm (top) and 56 cm (bottom) cab heights. (From Canyon Research Group Inc. 1982. *Human Factors Design Guidelines for Personnel Carriers*, 37 pp., Canyon Research Group, Westlake Village, CA.)

et al., 1986; Mason, 1992; Canyon Research Group, Inc., 1982). Figure 29.7 illustrates the effects of vertical space restrictions on seating envelopes for the 95th percentile miner for two cabs: 107 and 56 cm in height (Canyon Research Group, Inc., 1982). Comparison of the two cabs clearly illustrates the increased cab length, reduced reach envelopes, and restricted field of vision associated with a reclined seating posture. Collier et al. (1986) present three design options for underground equipment seating. These included “normal” seating (for canopies > 1460 mm, of roof clearances > 1610 mm), a version with an increased backrest angle for canopies between 1440 and 1460 mm, and a “constant eye-height” option for canopies between 1135 and 1285 mm. A special consideration for mining equipment seating is the provision of sufficient space so that the operator’s *caplamp battery* and *self-contained self-rescuer (SCSR)* can be worn on the belt. An example of such a design is provided in Figure 29.8 (McPhee, 1993).

Illumination

Proper design of illumination systems is a critical issue in the mining environment. In fact, underground mines (and surface nighttime operations) are often completely dependent upon artificial lighting systems.

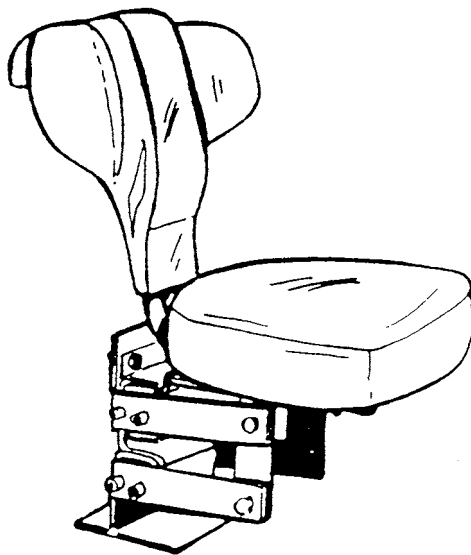

FIGURE 29.8 A prototype mining operator's seat developed using ergonomics principles and operator feedback. Note cutouts in the seatback, accommodating belt-worn personal protective equipment. (From McPhee, B. 1993. *Ergonomics for the Control of Sprains and Strains in Mining*. 36 pp., Handbook published by the National Occupational Health and Safety Commission (Worksafe Australia), Sydney. With permission.)

As humans receive the bulk of their information visually, the quantity and quality of illumination provided by lighting systems are extremely important for safety, productivity, and morale of the mining workforce (Sanders and Peay, 1988). Part 75.1719 of the Code of Federal Regulations discusses illumination requirements for different areas of underground mines, along with electrical standards, and other requirements to increase visibility in the mine environment (Lewis, 1986). The primary illumination standard states that underground equipment at the working face must provide *luminance* of at least 0.06 foot-Lamberts on the coal face. The illumination required to provide 0.06 foot-Lamberts (two footcandles) is adequate for most mining tasks, but is not so bright that severe adaptation problems will occur when the miner must go into darker areas of the mine (Lewis, 1986).

Presently, laboratory mockups are a major part of the process lighting equipment manufacturers (LEMs) must go through to design an approved underground machine-mounted illumination system. Moreover, when a lighting system is modified by using different *luminaires* within an existing configuration or by changing a luminaire's location or orientation, additional laboratory measurements may be necessary to approve the system. The U.S. Bureau of Mines, aware of the difficulties described above, has developed a PC-based computer model that will enable users to easily design, alter, and evaluate underground machine-mounted illumination systems without having to build a mockup or prototypes. A new method of modeling illumination provided by underground mobile equipment luminaires has been developed as part of this model (Gallagher et al., 1996). The Mine Safety and Health Administration has recently authorized the use of this computer model in the certification of mobile underground equipment illumination systems.

Control Design

An analysis of underground mining fatalities for the years 1972 and 1979 indicated that more than 7% of mining fatalities in underground coal mining during that period were associated with improper design of controls. The number of nonfatal injuries caused by poor control design remains unknown; however, it is safe to assume that this number is also substantial (Sanders and Peay, 1988). More recently, a spate of injuries among roof bolter operators also implicated control design as a contributing factor. A typical problem observed in mining equipment is lack of control standardization (Helander et al., 1980). An

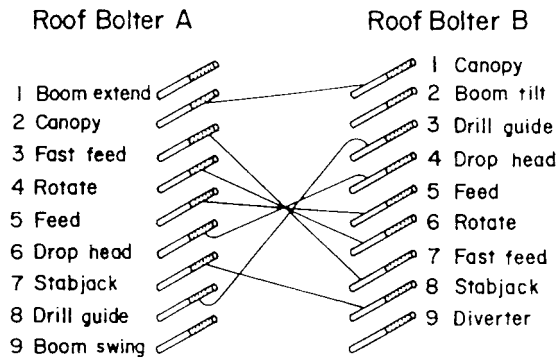

FIGURE 29.9 Different arrangements of roof bolter controls from the same manufacturer. (From Helander, M., Conway, E.J., Elliott, W., and Curtin, R. 1980. *Standardization of Controls for Roof Bolter Machines. Phase I. Human Factors Engineering Analysis* (contract HO292007, Canyon Research Group Inc.). Bureau of Mines PFR 170-82, NTIS PB 83-119149, 192 pp.)

example is provided in Figure 29.9. This figure depicts two varying arrangements of roof bolter controls, both coming from the same manufacturer. It is not an uncommon occurrence to have machines with different control arrangements working in the same mine, but perhaps in different *working sections*. If a worker who usually works on roof bolter A is suddenly called upon to fill in on roof bolter B, the risk of improper control activation is greatly increased. Many similar situations may be cited. Unfortunately, this is not an area where a great deal of progress has been made in mining. It is important that human factors design principles be considered in the design of new equipment, and, what is more important, that mines insist on good human factors design in their procurement process.

Maintainability Design

In the early days of mining automation, equipment consisted of relatively simple machines that could be easily maintained using simple hand tools. These have since been replaced by increasingly powerful and complex mining systems (Conway and Unger, 1991). The demands on the maintenance function have increased concomitantly. Unfortunately, little regard is given in the design of this equipment for ease of maintenance and serviceability. The following problems are most frequently observed in mining equipment (Long, 1983): (1) poor access to machine parts or areas for routine maintenance tasks, (2) inadequate access openings to reach parts needing repair or replacement, (3) need to remove or dismantle ancillary components to gain access to the failed unit, (4) inadequate provisions for safe handling of heavy or large parts, and (5) inadequate tools to perform required maintenance tasks. As a result of such design deficiencies, relatively simple maintenance tasks are turned into complex, time-consuming procedures. Recently, some recommendations for improving the maintainability design of mining equipment have been published (Conway and Unger, 1991). These recommendations contain both maintainability engineering information for equipment manufacturers and a buyer's guide for the evaluation of the maintainability design of mining equipment.

Ergonomics Design Guidelines

Some mining operations now require ergonomics evaluations to be performed on major items of underground equipment prior to their purchase (Mason, 1992). This is a positive development in terms of implementing ergonomics in mining, but also demands that appropriate design information be provided to engineers, designers, and purchasers of this equipment. In the late 1980s and early 1990s, a number of ergonomics design handbooks were developed for specific pieces of underground machinery (Canyon

Research Group, 1982; Collier et al., 1986; Mason, 1992). An effort to develop a generalized ergonomics measurement tool resulted in the Bretby Operability Index (Mason, 1992). This index provides a means through which an initial ergonomics screening of new equipment can be performed. Areas requiring a more detailed assessment can be quickly identified, so that ergonomists can focus developing recommendations in these areas.

29.8 Hand Tool Design

Most analyses indicate that hand tools are involved with between 7 and 10% of all nonfatal lost-days accidents in the mining industry (Marras et al., 1988a, 1988b; Sanders and Peay, 1988). Most of these injuries (approximately 75% or more) are associated with nonpowered hand tools. Many traditional hand tools are used in the mining industry. Of these, hammers, wrenches, and knives are most commonly implicated in accidents (Sanders and Peay, 1988). However, there are many specialty tools used for specific mining tasks, for example, the *scaling bar* or the *jack leg drill*. Many of these specialty tools also appear to have very high frequency and severity rates associated with them (Marras et al., 1988a, 1988b). The types of injuries associated with mining hand tools are most often struck-by and overexertion. There is some indication that the awkward postures observed in low-seam coal mines may contribute to both types of injuries. Research in this area has resulted in recommended design changes that may be useful in improving handtool design (Marras and Lavender, 1988). As an example, a counterbalanced scaling bar was developed which was found to significantly reduce compressive forces on the spine compared with the conventional scaling bar (Marras and Lavender, 1991).

29.9 Personal Protective Equipment

In response to the multiplicity of mining hazards, miners are equipped with an extensive array of personal protective equipment (PPE) (Sanders et al., 1981). This equipment includes (at a minimum) ear protection, safety glasses, respirator, hard hat, cap lamp and battery, mining belt, overalls, gloves, safety boots, self-rescue device, and in low-seam mines, knee pads. Unfortunately, much of this equipment has not received proper consideration with regard to ergonomics nor the unique environmental conditions present underground. However, in the past 15 years, a number of studies have been performed to address issues pertaining to miners' PPE. This research has resulted in the development of an improved slip-resistant tread design for mining boots, improved overall designs with retro reflective materials for increased detectability, and improved knee pad designs (Sanders et al., 1981).

Another item of PPE that is currently generating some controversy is the introduction of belt-worn self-contained self rescuers (SCSRs). These devices are heavier than the *filter self rescuers (FSRs)* they replaced, but have the benefit of immediately providing the miner with an hour's worth of oxygen to escape a mine fire. The FSRs worn previously were lighter; however, they were not protective from all noxious gases produced by a mine fire and still required the user to don another device before escape was possible. Some miners feel the new devices are too heavy and cumbersome, and are resisting the change. Research is currently under way to examine methods of improving the ergonomics design of these devices.

29.10 Status of Knowledge and Unresolved Issues

Our knowledge of ergonomics issues in mining has increased a tremendous amount over the last two decades. However, we would be sadly mistaken if we were to imply that all (or even a sizable portion) of the relevant issues were resolved. There remains much to be learned and surely some to be discarded from what we believe we know presently. The following list discusses some of the most important unresolved issues, in the author's mind, that need to be addressed:

1. Ergonomics research in mining has far outstripped its implementation by the industry. While there have been significant ergonomics success stories in mining, by and large effective mining ergonomics committees are relatively rare. How can we improve the dissemination of ergonomics information and facilitate the development of committees in this industry, particularly among smaller mines with limited resources?
2. The unique stresses of working in restricted postures do not appear to be well-addressed by many of our current ergonomics models. As we continue to develop our knowledge of the ergonomics and biomechanics of traditional industrial tasks, it is important not to limit our research too narrowly. We should continue to broaden the applicability of our models to atypical postures and unusual situations. This process would undoubtedly provide us with better insight into the adaptive mechanisms used by the body, and may well spawn new ergonomics and biomechanics paradigms.
3. Recent years have seen a rapid growth in the development of new mining technologies. However, human-centered design principles have often been neglected in the design and implementation of new equipment and new technologies (Randolph and Love, 1991). Increased technology transfer efforts must be focused on the manufacturing sector of the mining industry, so that equipment can be designed to facilitate increased productivity, decreased risk of accidents, and improved worker satisfaction and comfort.

Defining Terms

Caplamp: The lamp worn by a miner on his safety hat or cap for illumination purposes. The caplamp is powered by a rechargeable battery worn on the miner's belt.

Deep mine: A mine where the coal or mineral deposit is at a depth exceeding 915 m (3000 ft). Some gold mines have been sunk to depths exceeding 3050 m (10,000 ft).

Filter self-rescuer (FSR): A protective device, worn on the miner's belt, to be worn in the event of a mine fire or explosion. This unit protects the miner from the potentially lethal effects of carbon monoxide inhalation.

Jack leg drill: A percussive type of automatically rotated rock drill that is worked by compressed air. This drill has a supporting bar (leg) that allows the drill to be used to drill into vertical mineral faces.

Low-seam mine: In general, a mine where the mineral seam is less than 1.2 m (4 feet) in thickness.

Luminaire: A complete lighting unit. These are mounted on underground mobile equipment to ensure compliance with mine lighting regulations.

Luminance: The luminous intensity of a surface in a given direction per unit of surface area.

Roof bolter: In bituminous coal mining, a machine used to drill holes and install bolts into the roof of the mine to prevent rock and slate falls. The term may also refer to the operator of this machine.

Scaling bar: A barlike implement used to remove loose rock from the roof of the mine in order to prevent this rock from falling unexpectedly and injuring a worker.

Self-contained self-rescuer (SCSR): A self-sufficient breathing apparatus which provides respiratory protection in oxygen-deficient or highly toxic atmospheres. In contrast to the filter self-rescuer (which only provides protection from carbon monoxide), this unit isolates the wearer's lungs completely from the toxic atmosphere.

Stoop: A working posture involving bending the trunk forward and down, sometimes simultaneously bending the knees, commonly used in the cramped spaces in underground coal mines.

Stoopwalking: Walking in a stoop posture.

Working section: The area of the mine where the coal, ore, or mineral is being mined.

References

- Andersson, G.B.J. 1982. Measurement of loads on the lumbar spine, in *Symposium on Idiopathic Low Back Pain*. p. 220-251, Mosby, St. Louis.
- Astrand, P.O. and Rodahl, K. 1977. *Textbook of Work Physiology*, McGraw-Hill Book Company, New York, NY.
- Ayoub, M.M. and Mital, A. 1989. *Manual Materials Handling*. Taylor and Francis, London.
- Ayoub, M.M., Bethea, N.J., Deivanayagam, S., Asfour, S.S., Bakken, G.M., Liles, P., Mital, A., and Sherif, M. 1978. Determination and modeling of lifting capacity. Final report, Grant #5R010H-0054502, HEW, NIOSH. Texas Tech University, Lubbock, TX.
- Ayoub, M. M., Bethea, N. J., Bobo, M., Burford, C. L., Caddel, K., Intaranont, K., Morrissey, S., and Selan, J. 1981a. *Mining in Low Coal. Volume 1: Biomechanics and Work Physiology*. Final Report — U.S. Bureau of Mines Contract No. HO3087022. Texas Tech University, Lubbock, TX.
- Ayoub, M. M., Bethea, N. J., Bobo, M., Burford, C. L., Caddel, K., Intaranont, K., Morrissey, S., and Selan, J. 1981b. *Mining in Low Coal. Volume II: Anthropometry*. Final Report — U.S. Bureau of Mines Contract No. HO3087022. Texas Tech University, Lubbock, TX.
- Ayoub, M. M., Selan, J.L., Burford, C. L., Intaranont, K., Rao, H.P.R., Smith, J.L., Caddel, D.K., Bobo, W.M., and Bethea, N.J. 1984. *Biomechanical and Work Physiology Study in Underground Mining Excluding Low Coal*. Final Report — U.S. Bureau of Mines Contract No. JO308058. Texas Tech University, Lubbock, TX.
- Ayoub, M.M., Smith, J.L., Selan, J.L., Chen, H.C., Lee, Y.H., Kim, H.K., and Fernandez, J.E. 1987. Manual materials handling in unusual postures. Technical Report, Department of Industrial Engineering, Texas Tech University, Lubbock, TX.
- Banister, E.W. and Brown, S.R. 1968. The relative energy requirements of physical activity. Chapter 10 in *Exercise Physiology* Academic Press, Inc., New York, NY.
- Bedford, T. and Warner, C.G. 1955. The energy expended while working in stooping postures. *Br. J. Ind. Med.* 12: 290-295.
- Bobick, T. G. 1987. Analyses of materials-handling systems in underground low-coal mines, in *Proceedings of Bureau of Mines Technology Transfer Seminar, Bureau of Mines Information Circular 9145*, p. 13-20, U.S. Bureau of Mines, Pittsburgh, PA.
- Bobick, T. G., Gallagher, S., and Unger, R.L. 1988. Pilot subject evaluation of whole-body vibration from an underground mine haulage vehicle, in *Trends in Ergonomics/Human Factors V*, Ed. F. Aghazadeh, p. 521-528. Elsevier Science Publishing Co., Amsterdam.
- Bobick, T.G., Gallagher, S., and Unger, R.L. 1989. Effects of random whole-body vibration on back strength and back endurance, in *Advances in Industrial Ergonomics and Safety I*, Ed. A. Mital, p. 537-544. Taylor and Francis, London.
- Butani, S.J. and Bartholomew, A.M. 1988a. Characterization of the 1986 coal mining workforce. *Bureau of Mines Information Circular 9192*, 57 pp., U.S. Bureau of Mines, Minneapolis, MN.
- Butani, S.J. and Bartholomew, A.M. 1988b. Characterization of the 1986 metal and nonmetal mining workforce. *Bureau of Mines Information Circular 9193*, 49 pp. U.S. Bureau of Mines, Minneapolis, MN.
- Canyon Research Group Inc. 1982. *Human Factors Design Guidelines for Personnel Carriers*, 37 pp., Canyon Research Group, Westlake Village, CA.
- Collier, S.G., Chan, W.L., Mason, S., and Pethick, A.J. 1986. *Ergonomic Design Handbook for Continuous Miners*. 128 pp., Institute of Occupational Medicine, Edinburgh, Scotland.
- Conway, K. and Unger, R.L. 1991. Ergonomic guidelines for designing and maintaining underground coal mining equipment, in *Workspace Equipment and Tool Design*, Ed. A. Mital and W. Karwowski, p. 279-302. Elsevier Sciences Publishing Co., Amsterdam.
- Cornelius, K.M., Redfern, M.S., and Steiner, L.J. 1994. Postural stability after whole-body vibration exposure. *Int. J. Ind. Ergon.* 13(4): 343-352.

- Davis, P.R. and Troup, J.D.G., 1966. Effects on the trunk of erecting pit props at different working heights. *Ergonomics*. 9(6): 475-484.
- Davis, P.R. and Ridd, J.E. 1981. The effect of restricted headroom on acceptable lifting capacity. *Ergonomics*. 24: 239.
- Dolan, P., Mannon, A.F., and Adams, M.A. 1994. Passive tissues help the back muscles to generate extensor moments during lifting. *J. Biomech.* 27(8): 1077-1085.
- Durnin, J.V.G.A. and Passmore, R. 1967. *Energy, Work, and Leisure*. London: Heinemann Educational Books, Ltd., 166 pp.
- Duthie, J.J.R. and Anderson, M.A.D. 1962. Social and economic effects of rheumatic disease. *Arch. Environ. Health*, 4: 511-518.
- Floyd, W.F. and Silver, P.H.S. 1951. Function of the erector spinae in flexion of the trunk. *Lancet*, Jan 20: 133-138.
- Floyd, W.F. and Silver, P.H.S. 1955. The function of the erector spinae muscles in certain movements and postures in man. *J. Physiol.*, 129: 184-203.
- Freivalds, A. and Bise, C.J. 1991. Metabolic analysis of support personnel in low-seam coal mines. *Int. J. Ind. Ergon.*, 8(2): 147-155.
- Gallagher, S. 1989. Isometric pushing, pulling, and lifting strengths in three postures. *Proceedings of the Human Factors Society 33rd Annual Meeting*, pp. 637-640, Human Factors Society, Santa Monica, CA.
- Gallagher, S. 1991. Acceptable weights and physiological costs of performing combined manual handling tasks in restricted postures. *Ergonomics*. 34(7):939-952.
- Gallagher, S. 1997. Trunk extension strength and trunk muscle activity in standing and kneeling postures. *Spine*. 22(16): 1864-1872.
- Gallagher, S. and Bobick, T.G. 1988. Effects of Posture on the Metabolic Expenditure Required to Lift a 50-Pound Box, in *Trends in Ergonomics/Human Factors V*, Ed. F. Aghazadeh, p. 927-934, Elsevier Science Publishing Co., Amsterdam.
- Gallagher, S. and Unger, R.L. 1988. A biomechanical analysis of manual materials handling tasks in restricted working postures. *Proceedings of the Human Factors Society 32nd Annual Meeting*, p. 670-674, Human Factors Society: Santa Monica, CA.
- Gallagher, S. and Unger, R.L. 1990. Lifting in four restricted lifting conditions. *Appl. Ergon.* 21(3):237-245.
- Gallagher, S. and Hamrick, C.A. 1991. The kyphotic lumbar spine: Issues in the analysis of the stresses in stooped lifting. *Int. J. Ind. Ergon.* 8:33-47.
- Gallagher, S. and Hamrick, C.A. 1992. Acceptable workloads for three common mining materials. *Ergonomics*. 35(9):1013-1031.
- Gallagher, S., Marras, W.S., and Bobick, T.G. 1988. Lifting in stooped and kneeling postures: Effects on lifting capacity, metabolic costs, and electromyography at eight trunk muscles. *Int. J. Ind. Ergon.* 3(1):65-76.
- Gallagher, S., Hamrick, C.A., Love, A.C., and Marras, W.S. 1994. Dynamic biomechanical modeling of symmetric and asymmetric lifting tasks in restricted postures, *Ergonomics*. 37(8): 1289-1310.
- Gallagher, S., Hamrick, C.A., Cornelius, K., and Redfern, M. 1995. "Peak L5-S1 Moments Associated with a Cable Hanging Task," Poster Presentation at the 39th Annual Meeting of the Human Factors and Ergonomics Society Conference, San Diego, CA, October 9-13 1995.
- Gallagher, S., Mayton, A.G., Unger, R.L., Hamrick, C.A., and Sonier, P. 1996. Computer Design/Evaluation Tool for Illuminating Underground Coal Mining Equipment. *J. Illum. Eng. Soc.* 25(1): 3-12.
- Gary, R.C., Passmore, R., Warnock, G.M., and Durnin, J.V.G.A. 1955. Studies on expenditure of energy and consumption of food by miners and clerks, Fife, Scotland 1952. Medical Research Council Special Report Series.
- Grillner, S.J., Nilsson, J., and Thorstensson, A. 1978. Intra-abdominal pressure changes during natural movements in man. *Acta Physiol. Scand.* 103: 275-283.
- Hamrick, C.A, Cornelius, K.M., Rossi, E.W., and Unger, R.L. 1993. Appropriate ingress/egress dimensions for mobile underground mining equipment. *Int. J. Ind. Ergon.* 11:13-18.

- Hancock, P.A., and Vercruyssen, M. 1988. Limits of behavioral efficiency for workers in heat stress. *Int. J. Ind. Ergon.* 3(2): 149-158.
- Haselgrave, C.M., Tracy, M., and Corlett, E.N. 1987. Biomechanical effects of force exertions while kneeling. Paper in *Proceedings of the 31st Annual Meeting of the Human Factors Society*, p. 318-322, Human Factors Society, Santa Monica, CA.
- Helander, M., Conway, E.J., Elliott, W., and Curtin, R. 1980. *Standardization of Controls for Roof Bolter Machines. Phase I. Human Factors Engineering Analysis* (contract HO292007, Canyon Research Group Inc.). Bureau of Mines PFR 170-82, NTIS PB 83-119149, 192 pp.
- Hudock, S.D. and Keran, C.M. 1992. Risk profile of cumulative trauma disorders of the arm and hand in the U.S. mining industry. *Information Circular 9319*, p. 1-5, U.S. Bureau of Mines, Minneapolis, MN.
- Humphreys, P.W. and Lind, A.R. 1962. The energy expenditure of coal-miners at work. *Br. J. Ind. Med.*, 19: 264-275.
- Kamon, E. and Bernard, T. 1975. *Physiological Responses of Coal Miners to Emergency*. Annual Technical Report, Grant No. GO-115006, The Noll Laboratory for Human Performance Research, The Pennsylvania State University, University Park, PA.
- Kamon, E. Doyle, D., and Kovac, J. 1983. The oxygen cost of an escape from an underground coal mine. *Am. Ind. Hyg Assoc. J.* 44(7): 552-555.
- Kellgren, J.H. and Lawrence, J.S. 1952. Rheumatism in coal miners. Part II. X-ray study. *Br. J. Ind. Med.* 9: 197-207.
- Klein, B.P., Jensen, R.C., and Sanderson, L.M. 1984. Assessment of workers' compensation claims for back strains/sprains. *J. Occ. Med.* 26(6):443-448.
- Lawrence, J.S. 1955. Rheumatism in coal miners. Part III. Occupational factors. *Br. J. Ind. Med.* 12: 249-261.
- Lawrence, J.S. and Aitken-Swan, J. 1952. Rheumatism in miners. I. Rheumatic complaints. *Br. J. Ind. Med.* 9: 1-18.
- Leigh, J., Mulder, H.B., Want, G.V., Farnsworth, N.P., and Morgan, G.G. 1991. Sprain/strain back injuries in New South Wales underground coal mining. *Safety Sci.* 14:35-42.
- Lewis, W.H. 1986. *Underground Coal Mine Lighting Handbook* (In two parts: 1. Background and 2. Application) USBM, IC 9074, 1986, 42 and 89 pp., U.S. Bureau of Mines, Pittsburgh, PA.
- Lockshin, M.D., Higgins, I.T.T., Higgins, M.W., Dodge, H.J., and Canale N. 1969. Rheumatism in mining communities in Marion County, West Virginia. *Am. J. Epidemiology* 90(1):17-29.
- Long, D.A. 1983. Solving the problem of getting on and off large surface mining equipment. Paper in *Bureau of Mines Information Circular 8947*, pp. 3-16, U.S. Bureau of Mines, Minneapolis, MN.
- Love, A.C., Unger, R.L., Bobick, T.G., and Fowkes, R.S. 1992. *A Summary of Current Bureau Research into the Effects of Whole-Body Vibration and Shock on Operators of Underground Mobile Equipment*, U.S. Bureau of Mines Report of Investigations 9439, p. 1-15, Pittsburgh, PA.
- MacDonald, E.B., Porter, R., Hibbert, C., and Hart, J. 1984. The Relationship Between Spinal Canal Diameter and Back Pain in Coal Miners. *J. Occ. Med.* 26(1): 23-28.
- Marras, W.S. and Lavender, S. 1988. *An Analysis of Hand Tool Injuries in the Underground Mining Industries*. U.S. Bureau of Mines Final Report JO348043, 234 pp. The Ohio State University, Columbus, OH.
- Marras, W.S., Lavender, S., Bobick, T., Rockwell, T., and Lundquist, R. 1988. Risks of hand tool injury in U.S. underground mining from 1978 through 1983, Part II: Metal-nonmetal mining. *J. Safety Res.*, 19(3):115-124.
- Marras, W.S., Bobick, T.G., Lavender, S.A., Rockwell, T.H., and Lundquist, R.L. 1988. Risks of hand tool injury in U.S. underground mining from 1978 through 1983: Part I: Coal mining. *J. Safety Res.*, 19(2):71-85.
- Marras, W.S. and Lavender S. 1991. The effects of method of use, tool design, and roof height on trunk muscle activities during underground scaling bar use. *Ergonomics.* 34(2):221-232.
- Marras, W.S. and Sommerich, C.M. 1991a. A three dimensional motion model of loads on the lumbar spine: I. model structure, *Human Factors.* 33, 123-138.

- Marras, W.S. and Sommerich, C.M. 1991b. A three dimensional motion model of loads on the lumbar spine: II. model validation. *Human Factors*. 33, 139-150.
- Martinson, M.J. 1977. Heat stress in Witswatersrand gold mines. *J. Occ. Acc.* 1:171-193.
- Mason, S. 1992. Improving the ergonomics of British Coal's mining machinery. *Appl. Ergon.* 23(4):233-242.
- McGill, S.M. and Norman, R.W. 1987. Reassessment of the role of intraabdominal pressure in spinal compression. *Ergonomics*. 30(11): 1565-1588.
- McPhee, B. 1993. Ergonomics for the control of sprains and strains in mining. Handbook published by the National Occupational Health and Safety Commission (Worksafe Australia), 36 pp.
- Misaqi, F.L. 1984. *Heat Stress in Mining*. Safety Pamphlet No. 6, Mine Safety and Health Administration, Beckley, WV.
- Morrissey, S., Bethea, N.J., and Ayoub, M.M. 1983. Task demands for shoveling in non-erect postures. *Ergonomics*. 27: 847-853.
- Morrissey, S.J., George, C.E, and Ayoub, M.M. 1985. Metabolic costs of stoopwalking and crawling. *Appl. Ergon.*, 16(2): 99-102.
- Moss, K.N. 1934. The energy output of coal miners during work. *Trans. Inst. Min. Eng.* 189: 132-149.
- MSHA 1991. *Carpal Tunnel Syndrome*. Safety Manual No. 23, Mine Safety and Health Administration, Beckley, WV.
- Nachemson, A.L., Andersson, G.B.J., and Schultz, A.B. 1986. Valsalva maneuver biomechanics: effects on lumbar trunk loads of elevated intraabdominal pressure. *Spine*. 11(5): 476-479.
- NIOSH 1981. *Work Practices Guide for Manual Lifting*. NIOSH publication 81-122, NTIS PB 82-178948, 183 pp.
- Peay, J.M. 1983. Introduction. Paper in *Back Injuries. Bureau of Mines Information Circular 8948*, p. 2, U.S. Bureau of Mines, Pittsburgh, PA.
- Peters, R.H. 1983. Activities and objects most commonly associated with underground coal miners' back injuries. Paper in *Back Injuries. Bureau of Mines Information Circular 8948*, p. 22-31, U.S. Bureau of Mines, Pittsburgh, PA.
- Punnett, L., Fine, L.J., Keyserling, W.M., Herrin, G.D., and Chaffin, D.B. 1991. Back disorders and nonneutral trunk postures of automobile assembly workers. *Scand. J. Work Environ. Health*. 17: 337-346.
- Randolph, R.F. and Love A.C. 1991. Ergonomics in mining: Human factors and organizational research on high-technology mining. *Appl. Occ. Environ. Hyg.* 6(7):577-580.
- Remington, P.J., Andersen, D.A., and Alakel, M.N. 1984. *Assessment of Whole-Body Vibration Levels of Coal Miners. Volume II: Whole-Body Vibration Exposure of Underground Coal Mining Machine Operators* (contract JO308045, Bolt, Beranek, and Newman, Inc.). Bureau of Mines OFR 1B-87, NTIS PB 87-144119, 114 pp.
- Ridd, J.E. 1985. Spatial restraints and intra-abdominal pressure. *Ergonomics*. 28(1): 149-166.
- Sanders, M.S. and Kelley, G.R. 1981. *Visual Attention Locations for Operating Continuous Miners, Shuttle Cars, and Scoops. Volume I* (contract JO387213) Bureau of Mines OFR 29(1)-82, NTIS PB 82-187964, 142 pp.
- Sanders, M.S. and Peay, J.M. 1988. *Human Factors in Mining*. U.S. Bureau of Mines Information Circular 9182, U.S. Bureau of Mines, Pittsburgh, PA.
- Sanders, M.S., Peay, J., and Bobick, T.G. 1981. Research on the development of personal protective equipment for underground mines. Paper in *Bureau of Mines Information Circular 8866*, p. 70-83, U.S. Bureau of Mines, Pittsburgh, PA.
- Schlomka, G., Schroter, G., and Ocherwal, A. 1955. Uber derbedeutung der berufkischer Belastung fur die entsehung der degenerativen Gelenkleiden. *Z. Gesamte Inn Med.* 10:993-999.
- Schultz, A.B. and Andersson, G.B.J. 1981. Analysis of loads on the lumbar spine. *Spine*. 6(1): 76-82.
- Schultz, A., Andersson, G., Ortengren, R., Haderspeck, K., and Nachemson, A. 1982. Loads on the lumbar spine: Validation of a biomechanical analysis by measurements of intradiscal pressures and myoelectric signals. *J. Bone Joint Surg.* 64A(5): 713-720.

- Silver, P.H. 1954. Direct observations of changes in tension in the supraspinous and interspinous ligaments during flexion and extension of the vertebral column in man. *J. Anat.* 88: 550-551.
- Sims, M.T. and Graveling, R.A. 1988. Manual handling of supplies in free and restricted headroom. *Appl Ergon.* 19(4): 289-292.
- Snook, S.H. 1985. Psychophysical considerations in permissible loads. *Ergonomics.* 28(1): 327-330.
- Strydom, N.B. 1966. The need for acclimatising labourers for underground work. *J. Mine Vent. Soc. S. Afr.* 19: 124-125.
- Winn, F.J. and Biersner, R.J. 1992. "Exposure probabilities to ergonomic hazards among miners." Poster presented at 36th Annual Meeting of the Human Factors Society, Atlanta, GA, October 12-16, 1992.
- Wyndham, C.H., Strydom, N.B. Benade, A.J.S., and Rensburg, A.J. 1973. Limiting rates of work for acclimatization at high wet bulb temperatures. *J. Appl. Physiol.* 35: 454.

For Further Information

An excellent source of information pertaining to ergonomics in mining is the text *Human Factors in Mining* by Sanders and Peay. This text is becoming a bit dated (it was published in 1988); however, it remains among the most comprehensive treatments available.

30

Risk Assessment and Safety Management in Industry

30.1	Who Performs the Activities within the Scope of Risk Assessment and Management?.....	30-3
30.2	Provision of Information for Assessors.....	30-4
30.3	Selection of Assessed System and its Definition	30-5
30.4	Identification of Hazard	30-6
30.5	Identification and Analyses of Hazardous Situations.....	30-8
30.6	When Are the Hazardous Situation Analyses Performed?	30-9
	A Particular Example of Identification and Analysis of Hazardous Situation for a Steel Plant • Description of Installations Used in the Analyzed Object	
30.7	Assessment if the Requirements of Obliging Regulations and Standards Are Fulfilled.....	30-14
30.8	Risk Evaluation	30-16
	Probability of Arise of a Negative Event • Consequence of a Negative Event • Extended Risk Definition • Information in the Framework of Risk Assessment • Procedures for Performance of the Risk Analysis	
30.9	Assessment of System Safety.....	30-21
30.10	Arrangements for Decrease or Elimination of Risk.....	30-21
	Method of Safety Arrangements Priority • Method of Adaptation of Risk Parameters and Risk Factors	
30.11	Establishment of Priorities.....	30-22
30.12	Example of Risk Assessment Methods.....	30-22
	Combined Procedures	

Juraj Sinay

Technical University of Košice

All human activities carry a risk. The risk can apply to health and safety, e.g., immediate health damage or a gradual negative impact to health due to harmful substances, or it can cause economical losses, e.g., as a result of machine failure or destruction due to fire or explosion. The aim of the activities in the field of risk management is to control, eliminate, or minimalize the possibility of the risk of death, injury, illness, or damage to technical equipment or environment. At the same time the improvement of safety conditions and health protection at work in the man–machine–environment system is also observed with

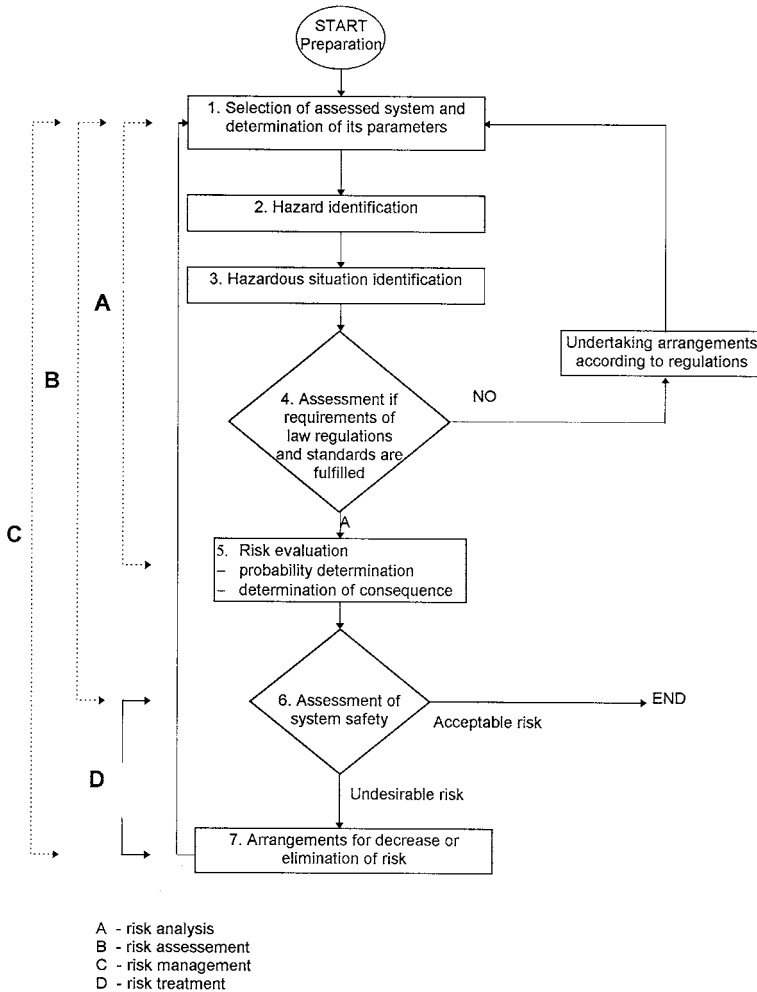

FIGURE 30.1 Risk Management scheme.

the goal to prevent economical losses due to an ineffective system of managing the work safety. There is also a legal requirement to present to inspection organs a systematic fulfillment of safety requirements according to the established legal regulations.

However, it is the task of an employer, or all the units of the man-machine-environment system, to keep the risk under control, i.e., to create conditions so that it achieves the value of an acceptable risk at most. This requires the possibility to analyze and classify risks in such a way that it is possible to carry out arrangements for their control with the aim to eliminate or minimize them, i.e., to use the activities complex from the risk management system^{1,2} (Figure 30.1). It is also possible to use simpler approaches to risk management in smaller and middle-sized companies which are shown in Reference 1.

The activities in the framework of risk management are performed in the man-machine-environment system which involves people, technological procedures, used materials, tools, machines and devices, software, fauna, and flora. Risk management mainly includes the following activities:

- Definition of the aim the analysis is performed for
- To set up the time plan and strategy of the risk assessment
- Establishing a working group and other persons who will participate in the process of risk assessment and management as well as providing their training

- To provide the essential information for risk assessment
- Description of the method used for the risk assessment
- To involve the executives in the accomplishment of the results of risk assessment and monitoring
- Installation of the risk assessment results into work organization and staff training
- To provide systematic repeated risk assessment

Risk assessments can be of different scope, content, form, method, and various procedures may be used. It depends on:

- *The purpose the analysis is to be done for.* There is one procedure when a designer evaluates the machine construction, and a different one when an operator detects that the machine in operation endangers somebody. There is a different procedure to find out the reasons for injuries, and a different one to demonstrate the accordance with safety regulations.
- *The kind of hazard and hazardous situation.* Different methods are used for chemical operations, different ones for machinery operations, different ones for special activities, e.g., chimney destruction.
- *The size of the operation, the branch of economical activity.* The larger the company, the more complex the work organization and the higher risk possibility, the more detailed will be the assessment.

The risk assessment strategy is based on the purpose of the analysis. In the framework of the strategy there is a determined proceeding for the risk assessment, definition of the assessed systems, danger detection, especially with regard to the operation site area, definition of all the operation procedures and operation activities. It is necessary to involve all the staff and other persons who might be exposed to hazard.

The time plan will put the single stages of the risk assessment into accordance as well as monitor the assigned tasks accomplishment.

30.1 Who Performs the Activities within the Scope of Risk Assessment and Management?

The performer of the activities within the scope of risk management must be a competent specialist with professional education and rich experience in the job as well as in the field of work safety. The employer might manage the risk assessment, especially if the operation is small and simple. In more complex operations, where there are more technical installations and technologies, and various activities are performed, it is necessary to assess the risks in a complex and systematic way. A group of experts from the following areas should deal with risk assessment:

- a. System analysis
- b. Theory of probability and mathematical statistics
- c. Technical areas, e.g., mechanics, material engineering, elasticity and strength, electrotechnics, nuclear technic, machine building
- d. Natural-science branches, e.g., chemistry, physics, biology
- e. Medical field, toxicology and epidemiology included
- f. Sociology, national economy branches, psychology, ergonomy
- g. Management theory

The risk assessment consists of a set of logical steps; however, its efficiency depends greatly on experience as well as decision-making skills of the assessors. Hence, the selection of these people and fulfilling the following principles are important:

- A working group is authorized to assess the risks, not only one person — thus the subjectivity of a human factor is eliminated;
- There should be an expert in the risk assessment theory as well as those who have knowledge of the operation, technology, or installation being assessed;

- It is necessary to involve the staff in risk assessment — technologists, technicians, executives, as well as employees working directly in the operation;
- It is an advantage to increase the number of external specialists since it provides an independent, professional view, free from “operation blindness”;
- From two to five coordinators should work in a working group, and other specialists will be called in according to the kind of hazard;
- It is necessary for the assessors to be qualified in their field.

They should have the ability to identify the hazard, to analyze how this hazard could endanger a man and to be capable of assessing the probability and consequence of the negative event:

- The employer should enable these people to take part in professional training not only in technical areas, but also in the methods of logical analysis, modeling, and evaluation
- Regardless of who does the risk assessment, the employer is responsible for the level of the risk assessment and assumed arrangements in every case

30.2 Provision of Information for Assessors

The persons who are to assess the risk should have the knowledge of a wide range of information, such as:

- Work organization and operation procedures;
- Machines, installations, technologies, and materials being utilized;
- Statistics, analysis, and injury accident rate;
- Sources of risk, risks already known;
- Relationship between the source of risk and its impact;
- Probability and consequence of hazards;
- Number of endangered persons, the extent of expected damages;
- Regulations, standards, and demands on safety.

This information may be obtained from the following sources:

- Technical and operation documentation of machines and technologies, organizational and technical regulations of the company, written directions and instructions, and operation procedures
- Data on injury accident and disease rate, undesirable events, failures, information on “almost accidents”
- Records from internal and external audits
- Consultations with specialists and staff
- Legislative regulations, standards, including the European ones, technical and scientific literature, instructions

Efficient risk control requires an analysis of the risk as the first step. When planning the goals that are to be achieved by a risk analysis, it is necessary to take the following activities into consideration:

- Selection of the assessed system and determination of its parameters
- Identification of hazard
- Identification of hazardous situation
- Assessment of the extent of the compliance with the law regulations
- Risk evaluation

All the stages of the technical life of the machine have to be the object of the analysis of the risk of technical systems (Figure 30.2).

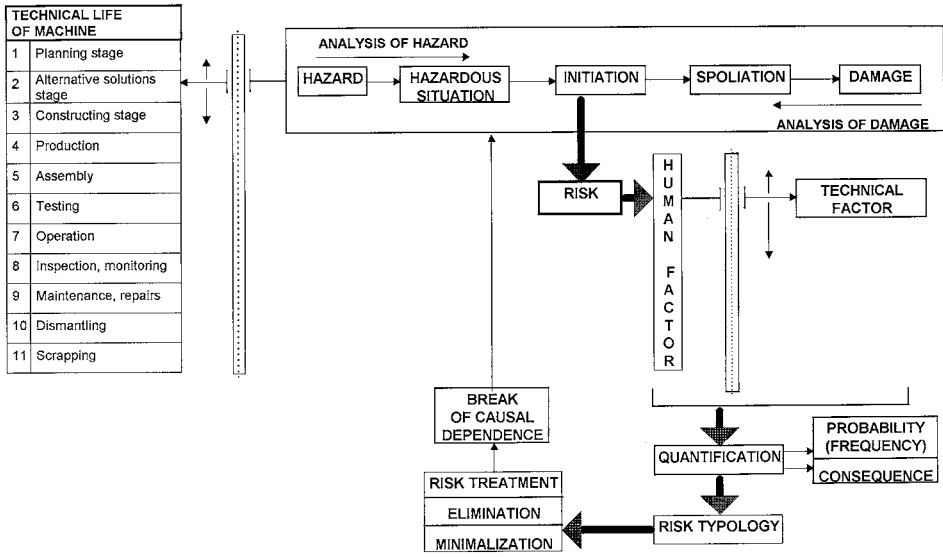

FIGURE 30.2 Scheme of analysis of technical systems risk.

- Risks at the stage of projecting and constructing
- Risks at the production stage
- Risks at the stage of assembly and dismantling
- Risks during operation
- Risk during maintenance and repairs
- Risks at re-valORIZATION of a part of the system or at its depreciation (scrapping, destruction)

Risk evaluation is the final stage of the risk analysis and it requires an analysis of probability of a negative event arising, the analysis of frequency, analysis of possible consequences, and their mutual relationship.

The procedure creates conditions for defining risk factors, i.e., the parameters that influence the probability and consequence of a negative event during the whole technical life of the installation.

It is possible to use the results of the risk analysis for the following:

- Determination of the conditions for risk acceptability
- Comparison of the risk with risks in the framework of other technologies, or activities
- Working out the proceedings for introduction of the arrangements for decrease or elimination of the risk at technical risks, e.g., by way of efficient maintenance activities
- Assessment of the efficiency of chosen arrangements for minimalization or elimination of the risk
- Preventing the rise of economic losses

The quality of the undertaken analysis requires perfect knowledge of the examined system, e.g., the machinery installations complex, or complex technology. The knowledge of the system altogether with verification of the suitability of the used kind of risk analysis enables the utilization of the results obtained from the analysis of one object with a certain level of adjustment also for similar installations or objects.

30.3 Selection of Assessed System and its Definition

The first step of the systematic risk assessment is a selection of the assessed system. The assessed system might be a machine, installation, technology, working space, working activity, used material, etc. which is to be examined. A precise definition of the assessed system will show where a hazard occurs.

There are actually two possible ways of selection:

- a. To list all the operation spaces, machines, installations, technological knots, working activities, and materials where it is possible to suppose hazard for the life and health of people. Each item of the list will be an independent assessed system where it is necessary to perform an analysis.
- b. According to the recommended general list of hazards, it is possible to find the places at the sites and in operation procedures where these hazards occur. These places will be an assessed system. For example, for the hazard of electric current, it is necessary to find out where and in what kind of activities it is possible to suppose the hazard for life and health of people. The advantage of this is that the next steps of the analysis will be the same for more assigned places — assessed systems.

In larger companies these lists could be endless; therefore, it depends on the assessors to decide where there is the highest presupposition of damage. The employees could be particularly helpful at this selection. It is necessary to take into regard not only common working processes, but also exceptional activities, (e.g., if a heavy burden is being carried up the stairs, special repairs, etc.). It is necessary to pay particular attention to dangerous substances whose undesirable impact can cause relevant losses. (A special regime is established for the prevention of major industrial breakdowns.)

Defining the assessed system, i.e., definition of its parameters, should also be a part of this step (for example, tension, speed of lifting, concentration, temperature, etc.). It is important due to the fact that in a situation when it would be necessary to take arrangements, one of the possible ways could also be the change of parameters of the assessed system that may be considered to be the risk factors.

The level of operators or users of the installation is also a part of the system characteristics. The essential thing is if the operators or users are trained, experienced, or there might appear third persons, i.e., nonprofessional people.

30.4 Identification of Hazard

If a chosen system is being assessed (e.g., machine, activity, working space), it is essential to identify the properties in this system that might cause a negative event in the form of injury, health endangering, or machine failure.

The proceeding is as follows: the assessors discuss with designers and schemers, technicians, maintenance men, executives, and workmen at the site about how they perceive the real condition of a machine during its operation, as well as what they know of particular dangers at the site and of their negative impact.

Another possibility is a systematic investigation of all the aspects of the assessed system according to the documentation, injury accident rate statistics, and other data, and to search for the dangers directly at the site.

The records on injury accidents that have already happened, as well as experience obtained from the results of the risk analyses performed in the past, can provide usable information for identification of hazard. It is necessary to realize that assessing these figures has a high level of subjectivity and therefore the identified hazards might not be the only ones that occur in the system.

The lists of kinds of hazard and hazardous situation are included in standards and manuals that might be a good tool for orientation in this field.

As for practical use, some examples of hazard can be used that apply to some working activities and situations:

- a. Working installations
 - Insufficient protection of rotating and movable parts
 - Free motion of parts or material (falling, rolling, sliding, tilting over, flying away, swinging, warping) that might strike a person
 - Motion of machines and means of transport

- Danger of fire or explosion (friction, pressure tanks)
- Capture, cutting, pulling-in, stabbing, stroke, bruising, amputation (mechanical hazardous situations)
- b. Working habits and arrangement of sites
 - Dangerous surfaces (sharp edges, corners, points, rough surfaces, slippery surfaces of outstanding parts)
 - Work in altitudes
 - Work in unsuitable position (one-sided load)
 - Limited space (work among fixed parts)
 - Stumble and slip (damp and slippery surfaces)
 - Stability of worker
 - Impact of use of OOPP
 - Working techniques and methods
 - Entrances and work in closed space
- c. Use of electricity
 - Electric switches of machines
 - Electric installation
 - Electric equipment, operating devices, isolation
 - Mobile electric equipment
 - Electric energy that might cause fire or explosion
 - Overhead electric lines
- d. Exposure to substances dangerous to health
 - Breathing-in, consumption, or absorption of dangerous substances through skin, aerosols and fine parts included
 - Use of inflammable and explosive materials
 - Oxygen shortage
 - Presence of agents
 - Reactive substances
 - Irritant substances
- e. Exposure to physical factors
 - Electromagnetic radiation (heat, X-ray, ionizing)
 - Lasers
 - Noise and ultrasound
 - Hot substances and environment
 - Cold substances and environment
 - Media under pressure (pressed air, steam, liquids)
- f. Exposure to physical factors
 - Risk of infection by micro-organisms (exo- and endotoxines)
 - Presence of allergens
- g. Factors of environment and working climate conditions
 - Unsuitable lighting
 - Unsuitable temperature, humidity, ventilation
 - Pollution, mess
- h. Relation between working place and human factor
 - Safety system depends on obtaining and processing precise information
 - Dependence on staff knowledge and skills
 - Dependence on good communication and right instructions for change of conditions
 - Consequence of supposed not complying with the safe operation procedures
 - Suitability of personal working preventatives
 - Weak motivation to work safely
 - Ergonomic factors

- i. Psychological factors
 - Working loading (intensity, monotony)
 - Site dimensions, e.g., claustrophobia, loneliness at the site
 - Impact of conflicts
 - Impact of decision-making in a stress (loading) situation
 - Low level of work management
 - Reactions in case of an emergency situation
- j. Work organization
 - Factors of working process (night work, rest, ...)
 - Management of safety and health protection at work
 - Strategy and management of maintenance, especially safety equipment
 - Providing the investigation of injury accidents and extraordinary situations
- k. Other factors
 - Dangerous acting of other persons
 - Work with animals
 - Unfavorable weather conditions
 - Changing the sites
 - Work under water, etc.

30.5 Identification and Analyses of Hazardous Situations

Once the hazards have been identified, it is necessary to determine how they can cause an injury, damage, failure — negative event. One or more hazardous situations can be derived from one hazard. When identifying hazardous situations, the assessors should consider the following aspects:

- Who might be exposed to the effect of the hazard?
Not only production staff is taken into regard, but also auxiliary and service activities — maintenance men, cleaners, workers of other firms and operations, visitors, emergency service and rescuers, excursions, etc.
- What is the reach of the hazard impact?
It is necessary to know about hazardous situation zones, as well as the hazard impact; for example, the zone of hazard in case of escape of a dangerous substance, dangerous reach space of a crane.
- Characteristics of hazard and the way of initiation, creating dangerous situations and level of protection.
Hazardous situation also depends on the parameters of the assessed system and hazard. For example, other possibilities of injury arise at higher speed. The extent of hazardous situation also depends on the level of possible protection. For example, if the hazard is electric current that is objectively present in the investigated system, it is not necessary to take the hazardous situation into consideration if the isolation of conductors is sufficient and circuit protected.

The methods for hazardous situations identification can be divided into two groups:

- a. Comparative methods — the method of questionnaires and method of catalogue pages for hazardous situations, or risk and methods based on the use of data from the past
- b. Basic methods based on the answers to “What happens if...”. It is possible to use HAZOP (Hazard and Operability Studies) and FMEA (Fault Modes and Effect Analysis).

Inductive methods use assumed course of the system behavior. These methods use combinations of possible negative events in the system and, basing on them, the result at the end of the whole process is assessed — prospective methods. The methods ETA (Event Tree Analysis) and PHA (Preliminary Hazard Analysis).

30.6 When Are the Hazardous Situation Analyses Performed?

- a. If it is necessary to obtain data for decision-making in the field of system safety
- b. If the existence of hazard in individual working systems was confirmed on the basis of various data
- c. If an obvious increase of work injuries, accidents, or failures, or occupational diseases occur at particular work places
- d. If the risk management system is to be applied

A Particular Example of Identification and Analysis of Hazardous Situations for a Steel Plant³

A great significance is attached to the determination of a hazardous situation at a site as a basis for risk evaluation. There is a duty for the employer to find the hazardous situation at the site that emerges from the European Union law No. 9, paragraph 1a, and Guidelines 89/391/EU. To comply with this requirement, it is necessary to determine the kinds of hazardous situations that are characterized by:

- Dependence on injury accidents — only hazardous situations that have already led to damage are registered
- Indirectness — coming out of the damages that have occurred, the energy that caused them is assessed
- Limitation — only the hazardous situation of direct injury and not the hazardous situation of health are taken into consideration

It is possible to determine a hazardous situation by way of analysis that is:

- Independent of the kind of negative event — the hazardous situations that have not caused any injury or material damage are traced
- Direct — coming out of the known energy, the possibilities of a negative event are assessed
- Extensive — direct injuries as well as indirect injuries (almost injuries) are taken into account

The basis for carrying out the hazardous situation analysis is as follows:

- Information on the consequences of negative events that have already occurred, e.g., injury accidents
- Information on diseases that arose during work
- Information from the staff of the site where the analysis is being done as well as information obtained by systematic assessing of the safety of machines and installations

To ensure that the activities in the framework of safety assessment and health protection are efficient, it is essential that hazardous situation analyses be oriented toward the already arisen damages, and mainly toward the operations where there is the highest level of hazard, i.e., risk. In the area of metallurgical technologies, it is the operation “Steel plant” where hazardous situation analysis has been carried out.³ Its accomplishment comes out of the following presumptions:

- Performance of a preliminary analysis
- Determination of hazardous situation on the basis of information from four companies of metallurgical industry
- Detection of hazardous situation will only be limited to normal operation; the conditions of failure will not be considered in the given example
- Information on sources of negative events will be used in hazardous situation determination

TABLE 30.1 Phases of Production Technology in the Operation of Converter Steel Plant

Main system	Converter steel plant
Subsystem	<ol style="list-style-type: none"> 1. Filling pit/pig iron mixer 2. Pig iron processing 3. Manipulation with slag 4. Steel alloying 5. Melting process — convertors 6. Steel treatment — secondary metallurgy

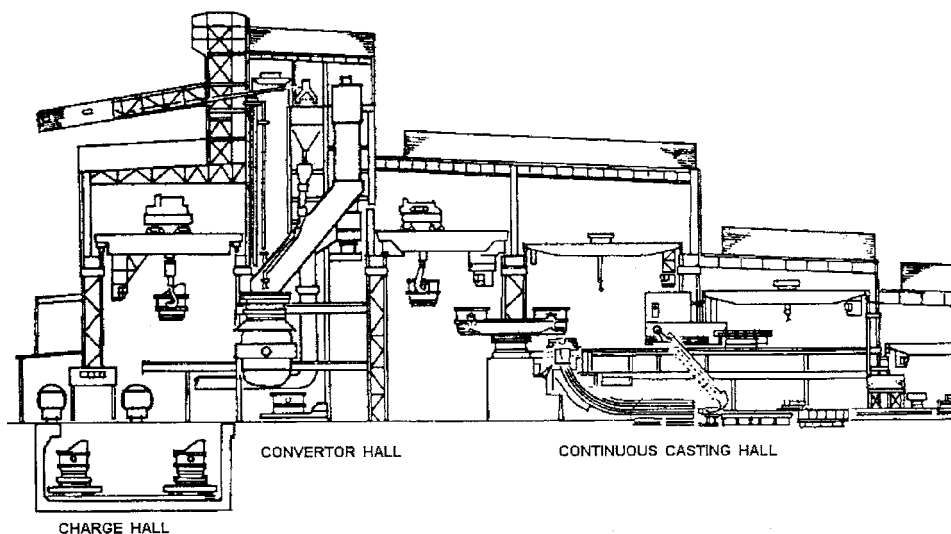

FIGURE 30.3 Converter steel plant scheme.

Description of Installations Used in the Analyzed Object

Technological installations of steel plants can be divided into the following main units:

1. Converter steel plants
2. Electric steel plants
3. Casting
4. Lining unit
5. Manipulation with slag

and at the same time the hazardous situation analysis is performed for the converter steel plant. The operation of converter steel plant can be divided into the following phases of production process (Table 30.1).

Converter Steel Plants

Using the oxidation process, steel is produced from pig iron in converter steel plants. The process of pig iron processing in a converter is preceded by its treatment. Blowing in the converter is followed by final steel treatment by means of so-called secondary metallurgy. The scheme of the production process is shown in Figure 30.3, and the course of technological process is apparent from the Figure 30.4.

Stages within the scope of carrying out the hazardous situation analysis

Hazardous situation analysis includes the following stages:

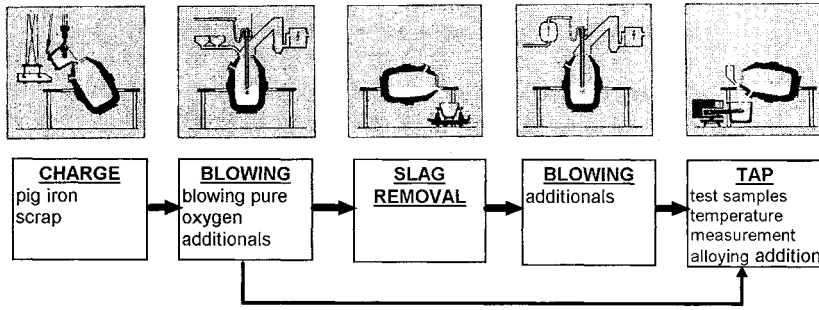

FIGURE 30.4 Scheme of blowing process.

TABLE 30.2 Form for Performing the Hazardous Situation Analysis

FORM: Hazardous situations analysis				
Production phases Main system: Subsystem:		Page: Date: Employee:		
	Production stage	Hazardous situations complex	Goal of protection	Regulations
				Arrangements

- 1st stage Determination of the production process phases — (Table 30.1).
- 2nd stage Attaching the information on hazardous situation to individual phases of production process. The information on occurred injury accidents and diseases will be attached to individual phases of production process, defined in the 1st stage, and the damages will be described.
- 3rd stage Detection of a hazardous situation — real state. The phases of production process according to the 2nd stage are investigated and they are attached to direct hazardous situations. Besides the injury accidents, the information on almost injuries is obtained, i.e., on hazardous situations that have not led to a negative event.
- 4th stage Determination of the goals of protection. The required state is derived and determined on the basis of information about the real state. The determination of the goals of protection assigns the future state of the installation safety.
- 5th stage Determination and performance of safety arrangements. Determination of arrangements is actually a decision about the kind and way of eliminating the difference between required and real state.
- 6th stage Monitoring of the impact of undertaken arrangements. The monitoring will be done by means of monitoring steps if the undertaken arrangements led to the achievement of the state required.

The form “Hazardous situation analysis in a steel plant” Hazardous situations, goals of protection and arrangements are efficiently recorded in forms, e.g., according to Table 30.2. With regard to the fact that it is a rough analysis, it is possible to use the term *hazardous situation complex* instead of the term *hazardous situation*.

TABLE 30.3 Checklist of Hazardous Situation Factors

1	Mechanic energy
1.1	Dangerous places
1.2	Rolling, frictional and tilting motions
1.3	Motions of machines and vehicles
1.4	Dangerous surfaces
1.5	Hazard of fall
2	Electric energy
2.1	Electric current
2.2	Electric and electromagnetic fields
3	Chemical energy
3.1	Hazard of fire and explosion
3.2	Dangerous substances
4	Thermal energy
4.1	Hot substances/environment
4.2	Cold substances/environment
5	Other energies/factors
6	Factors of working environment
6.1	Lighting
6.2	Climate
6.3	Noise
6.4	Mechanical vibration
6.5	Radiation
7	Physiological factors
7.1	Muscular work
7.2	Antropometrical parameters
8	Psychological factors
8.1	Receiving the information, processing, communication
8.2	Motoric habits
8.3	Knowledge and skills
8.4	Acceptance of safe behavior
8.5	Assessment of hazardous situation
9	Organizational factors
9.1	Working process factors
9.2	Team/individual work
9.3	Management/organization of work safety
10	Combined factors
	e.g., control/regulation systems

For application of the analysis results, e.g., in a group of the steel plant executives or for the representatives of trade unions, it is an advantage to also present in the form the information on the determined goals of the protection, e.g., safety regulations.

An aid is necessary for systematic hazardous situations detection that will help the elaborator distinguish the hazardous situations. A checklist from Nohl and Thiemeck⁴ should be used for this purpose (Table 30.3).

With this control sheet it is possible to examine systematically the existence of the hazardous situation factors in every phase of the production process. Using this procedure, the probability that some of the factors will not be taken into consideration is very low.

Determination of the complex of hazardous situation and defining the goals of protection

Table 30.4 shows the example of a preliminary analysis, then hazardous situation complexes are defined and goals of protection determined, and arrangements for their achievement are presented.

To determine the goals of protection, the following procedures⁶ can be used according to Meisenbach⁵ and Schneider⁶:

1. Working out the review of possible goals of protection based on:
 - Elimination of hazardous situation
 - Technical prevention of hazardous situation impacts

TABLE 30.4 Example of a Preliminary Analysis

FORM SHEET: Hazardous situation analysis

Production phases

Main system:

Converter steel plant

Subsystem:

FILLING PIT

Page: 1

Date: 04.03.1997

Worker:

Production stage	Complex of hazardous situation	Goal of protection	Regulations	Arrangements
Delivery of liquid pig iron in a tandish by railway	Railway entering steel plant hall and in the reach of it occurring: • persons • vehicles • material	Rails • keep free • entry for specified persons exclusively		Safety signs
		Test of vehicles		
		To assure • advising people • assurance of stopping before obstacles in time	Appropriate intraplant regulations and articles containing definitions of individual goals of protection	Executive instructions for railway To keep the rule “step speed” in hall
		Safety stops at the end of rail		
	Derailment of carriage at the end of rail	Fixing the carriages		Buffer gear
	Movement of laid-by carriages when loading and unloading tandish			Executive regulation for attendance
Hazard of burning due to pouring out liquid pig iron from surcharged tandish		Keeping the appointed level		Regulation of - BF operation
		Assurance of transport on rails in case of surcharged tandish	Appropriate intraplant regulations and articles containing definition of individual goals of protection	- railway transport Regulation in steel plant
		Assurance of safe distance when transferring tandish by crane		

- Prevention of or influencing the hazardous situation due to use of personal working preventatives
 - Controlling the hazardous situation by safe behavior
2. Determination of expected level of safety taking into regard the kind, consequence, and probability of possible injury
 3. Consideration of hazardous situation by safe behavior

Determination and performance of arrangements

The determination and performance of arrangements is the task of the steel plant executives taking into regard the rights of employees. When formulating decisions, the management is left to the professional standpoint of experts in the area of safety and protection of health at work. The workers of the operation being analyzed also have to be members of the teams.

The results of the preliminary “rough” analysis

When taking the phases of the production process in a converter steel plant into consideration, the hazardous situations shown in Table 30.5 are for injuries and in Table 30.6 for occupational diseases. The results do not offer the total review of all the hazardous situations in the scope of technological process, neither do they determine their extent, i.e., risks. Experts use them for directing the resulting activities in the framework of risk management.

30.7 Assessment if the Requirements of Obligatory Regulations and Standards Are Fulfilled

This step is not often included in the algorithm of risk management. It is often an obvious assumption that the assessed system complies with the safety regulations given by laws, public notices, guidelines, technical standards, etc. From experience it appears to be favorable to include this step even before the risk evaluation. Respecting the law enactments, it is possible to influence the risk parameters to a great extent. If the state is put into accordance with safety regulations in this step, it will not be necessary to take into regard the risk that these regulations deal with.

Thus, in this step the assessors compare if the given regulation, technology, space, etc. comply with the requirements of actual safety regulations and standards, but also technical documentation and instructions of the producer.

TABLE 30.5 Injuries as a Result of Hazardous Situation

HAZARDOUS SITUATIONS — INJURIES	
<i>TECHNOLOGICAL OBJECT: STEEL PLANT</i>	
<i>Main system</i>	<i>Converter steel plant</i>
<i>Subsystems</i>	<i>Complexes of hazardous situations</i>
1. Filling pit/pig iron mixer	A. Transport of liquid metal by: crane special vehicles railway charging equipment in: + tandishes + buckets <i>hazardous situation due to</i> RE sprayer hot liquid metal spilled in the hall — pouring out of tandish slag falling out of tandish effect of heat to clamping devices when transporting by crane surcharged tandishes

TABLE 30.5 (continued) Injuries as a Result of Hazardous Situation

	<ul style="list-style-type: none"> hazard of fall in area of filling pits collision between attendants and vehicles, as well as between vehicles power failure at mobile mixer during rotation
2. Pig iron treatment	<ul style="list-style-type: none"> places of pressing and cutting at output hazard of burning at sample withdrawal RE sprayer unsuitable floors for transport of additionals by means of transport concentration of humidity in buckets for slag dismounting of rinsing jet filling and storing of CaC_2 — hazard of creation of acetylene removal of sediments by hand tools and crane transport of liquid metal by crane collision between people and spatial transporters
3. Scrap unit	<ul style="list-style-type: none"> falling pieces of scrap explosives in scrap
4. Melting process converter	<ul style="list-style-type: none"> falling pieces of scrap ignition in converter due to existence of explosives or hollow bodies ignition in converter due to damp scrap or alloying addition insufficient coordination between a cranes and vectorer of converter boling in converter transport of liquid metal by crane falling sediments motion of converter and protective gates delay of reaction in converter oxygen jet cooling jet mouth suspension devices hazard of ignition and poisoning conditioned by creation of CO in combustions of converter boiler house — cooling water collision of persons and vehicles steel sprayer
5. Alloying	<ul style="list-style-type: none"> ignition at deslagging with accumulated humidity alloying additions falling down from lorry fall into deep storage tank automatic drive in of transport means collision of persons and vehicles manipulation with barrels automatic motion of conveyors objects falling down from conveyors transport of fine grain alloying additions — explosion due to dust emptying the storage vehicles
6. Additional steel treatment — desulfurization	<ul style="list-style-type: none"> steel sprayer flames — desulfurization hazard due to dust explosion hazard of ignition at uncontrollable output of desulfurization aid break of tandish in pit falling sediments dangerous anchorage of tandish at scavenging by argon transport of tandish by crane CO gas leaking spots on systems of inert gas

TABLE 30.6 Occupational Diseases as a Consequence of Hazardous Situation

HAZARDOUS SITUATION — OCCUPATIONAL DISEASES	
TECHNOLOGICAL OBJECT: STEEL PLANT	
Main system Subsystems	Converter steel plant Complexes of hazardous situations
1. Filling pit/mixer of pig iron	high temperature infrared radiation dust noise
2. Pig iron treatment	high temperature infrared radiation gases, smoke, and dust noise dangerous substances — additional
3. Scrap unit	lifting and transfer of burdens dust noise
4. Melting converter	radioactively contaminated scrap high temperature gases and smoke CO — gas radioactively contaminated scrap
5. Alloying	dust noise lifting and transfer of burdens
6. Additional steel treatment	high temperature dust and smoke creation of acetylene CaC_2 creation of CO gas

This decision block appoints another procedure in the framework of the risk analysis as follows:

- If the legislative requirements are not fulfilled, it is necessary to accomplish the arrangements according to regulations, and to check again if the parameters of the assessed system have not changed, as well as what hazard and hazardous situation it implies
- If the legislative requirements are fulfilled, a further step is taken

30.8 Risk Evaluation

The risk (R) is expressed by probability of arise (P) and at the same time consequence of a possible undesirable event (D):

$$\text{Mathematically expressed: } \mathbf{R = P \times D}$$

The sign \times expresses the function according to the kind of evaluation. It can be a matrix or product. The risk evaluation can be performed in two forms and it depends on the obtained information, potentiality of assessors, and also on the purpose of the risk assessment, kind of hazardous situations, etc. The risk evaluation can be as follows:

- **Qualitative** evaluation uses verbal expression to describe different levels of probability and consequences. It is mostly used for obtaining the general view of risks in case of a simple operation or in case of lack of figures for quantitative evaluation.
- **Semiquantitative** evaluation is a procedure in which the qualitatively described scales are attached numerical values by combination of which the level of hazardous situation is determined, and the

value of risk is determined. It is an ideal method for verification of risks at the site serving as bases for safety arrangements in operation

- **Quantitative** evaluation uses numerical values of probability (1× per 100,000 cycles, 1 injury per 100,000 employees, etc.) and of consequence of an undesirable event (value in currency, degree of health damage, political damage, ecological, etc.). It is used for precise and consistent risk evaluation, especially for machine construction, use of dangerous substances, etc.

Probability of a Negative Event

The assessors have to do an expert estimate, i.e., what is the probability of accident? It can be expressed either by proportional values: frequent, occasional, rare, or by a number expressing that the accident happens once per a certain number of events or per a time unit. In a practical life as well as in professional literature,^{7,8} the term frequency of hazardous situations or a negative event occurrence is also used. Basically, there is no difference between probability and frequency. The frequency is expressed in the form of discrete values, and it is a presupposition for determining the probability.

Probability is expressed in a more general way, e.g., in percents, and it can be functionally dependent. Frequency expresses the intensity of the hazardous situations that have been determined on the basis of the analysis of evaluated or supposed negative events. It is possible to express it by an integer, e.g., 10^{-5} means that a negative event has occurred 1× from the total number of 100,000 events.

It is favorable to determine (estimate) the probability (frequency) even in the stage of identification of hazard or hazardous situation. This procedure can be performed by:

- Using the information about events that have already happened. Using the statistical data processing, it is possible to determine the probability (frequency) of the event occurrence in the past, and then to use this information for risk assessments (evaluation, estimate) also in future analyses. This can be used for the risk evaluation of similar objects if it is possible to determine the level of similarity. This method uses the *post factum* procedure.
- The prediction of the probability value of the negative event based on some suitable methods, e.g., tree analysis. The frequency values can be determined on the basis of the figures that are defined for single components, subsystems, or whole constructions, and, at the present time, they are also worked up in a form of catalogues, e.g., NASA, DAIMLER, or for common components.⁸ In some concrete cases retrospective data are also available that can be used with the greatest degree of approaching the real values. The method is based on the *ante factum* principle.
- Use of the knowledge and experience of experts, who obtain reliable data on the probability of a negative event on the basis of questions formulated in appropriate ways.

It is possible to use particular procedures either individually or in mutual combinations. The first two procedures complete each other in a suitable way, and utilizing them in the framework of one analysis increases the statement reliability of the obtained results. In case neither of these two methods can be used, it is necessary to rely on the estimates of experts.

As for practical expression of frequency, it is possible to use, e.g., the procedure that uses “frequency,”²⁰ while the basis is the recognition that the absolute data only have a very limited statement value. It is therefore purposive to choose a base value, and to compare it with absolutely obtained values according to the relation:

$$\text{Frequency “P”} = \frac{\text{number of negative events } 10^6}{\text{total number of hours worked}} \quad (1)$$

The base value has to be linked with the number of hours worked (denominator in the formula (1)), e.g., for work at a lifting machine it is not the time from the beginning of shift that is calculated, but the truly worked hours on the lifting machine that are possible to be defined by computer of work cycles.

The factors that influence the probability of an undesirable event can be summed up into the following items:

- A. Measurable factors:
 - Length of hazard acting, time of exposure
 - System parameters (speed of machine, etc.)
 - Rapidity of the event arising
- B. Nonmeasurable factors:
 - Human factor — qualifications, attention, stress, etc.
 - Level of maintenance activities
 - Quality of control, revision, and testing activities
 - Non-failure and observance of safety arrangements
 - Ability to identify existence of hazard

The determination of the impact of particular factors on the frequency of a concrete negative event is the contents of professional discussions of assessors. At the same time the assessors consider the necessity of regarding other factors when merging the frequency into groups. The factors can depend on the kind of activity or type of technology.

Consequence of a Negative Event

An estimate of impact of a negative event on people, technical objects, and surroundings will be performed within the framework of the consequence of the negative event analysis in case it really occurs. Then the attention has to be paid to the kind of hazardous situation, as well as to the kind of human damage that might happen — light, severe, mortal injury — or to what the value of technical (material) damage would be expressed in financial units. To assess the consequences of a negative event, e.g., in the chemical industry, it is possible to use, in a suitable way, the methods of mathematical simulation that enable us to establish how many persons will be affected or what area will be contaminated. Similar models can also be used for an estimate of damage consequences in substantially simpler cases, e.g., for swinging a burden on a suspension device where using mathematical models, it is possible to determine the area to which people should be denied entry.

For the analysis of possible consequence due to damage, it is necessary to consider the following circumstances:

- a. Undesirable negative events causing damage are the base for analysis
- b. All the consequences of a negative event have to be identifiable and describable
- c. All the protective arrangements enabling reduction (minimalization) of the negative event consequences have to be taken into regard
- d. It is necessary to assign criteria that are the base for assessing the negative event consequences
- e. The existence of not only the immediate direct consequences of an event, but also of the ones that might arise as their impact later, after a certain time
- f. The possibility of secondary consequences, e.g., hazardous situation of other elements in the framework of the investigated man–machine–environment system

At the same time, the factors that influence the probability of an accident should be taken into consideration:

- A. Measurable factors
 - Kind of injury — light, severe, mortal
 - Number of endangered people
 - Financial loss also involving all the costs of the operation revival; parameters of the system (height of the site, weight of the manipulated burden, speed of motion)

- B. Nonmeasurable factors
- Relation between hazard and its effect
 - Emergency arrangements, crisis plans
 - Complexity of technology or machines

Some of the common forms of expressing the negative event consequence are as follows:

- a. Kind of injury — light, severe, mortal
- b. Financial loss expressed by a complete calculation taking into regard all the necessary costs of the revival of — defined by technical conditions — operation state
- c. Value according to the formula⁹

$$\text{Consequence "D"} = \frac{\text{Number of days of stoppage}}{\text{Total number of negative events}} \quad (2)$$

or

$$\text{Consequence "D"} = \frac{\text{Number of days of stoppage } 10^3}{\text{Real number of operation hours}} \quad (3)$$

To compare individual values, it is possible to use:

$$\text{Consequence "D"} = \frac{\Sigma \text{ real operation hours}}{\Sigma \text{ stoppage hours}} \quad (4)$$

In the scope of the assessment, the negative event consequences, i.e., assessment of arisen damage, these types of risks have to be taken into regard:

- Individual risk — impact on one person from a group
- Risks at the site — risk of health damage at work
- Risk at general public activities — impact on all persons
- Risks linked with technical objects — losses from downtime, penalties, etc.
- Risks of impact on environment — water, soil, air, fauna and flora

Extended Risk Definition

Overall risk evaluation, however, also requires consideration of other parameters characterizing the impact on the negative event. These include:

- a. Continuation of conditions for a negative event — time exposure “E” (the longer the duration of the conditions for the event, the higher probability that the event arises, and vice versa)
- b. The possibility to use protective arrangements “O” in the stage of a hazardous situation

Then, according to Reference 10, it is possible to use a so-called extended definition for the risk evaluation in the form of:

$$R = P \times D \times E \times O$$

which is a base for the use of some methods for risk evaluation, e.g., methods of net graphs.

Information in the Framework of Risk Assessment

The possibility to use an optional method of analysis and accordingly risk assessment requires data about the negative event in a form so that they are the most possibly precise and well-turned, but at the same time they have to be reproducible.

When evaluating the information on negative events, it can be stated that it is not possible to carry out the comparison of obtained information among subjects in the framework of one country as well as among states mutually. This claim can be made clear by the fact that in Germany a negative event in the form of an injury is only registered when disability is longer than 3 days. There are countries where every negative event connected to injury during working process is registered to be an injury accident. Also the definition of a severe injury is not established explicitly, and owing to this it is assessed in different ways in practical life. This fact may be made even more clear by the fact that while it is not possible to appoint particular parameters sharply at classification of probability and consequences, there is a space for subjective qualitative evaluation.

Therefore, it is recommended that the analyses in the framework of one subject (firm, company, group of citizens) are carried out by one specialist or one team of specialists. In case there is an attempt to compare several subjects, it is possible to have the analysis carried out by one independent institution where it is guaranteed that the qualitative assessment of the risk parameters will comply with particular criteria.

Risk assessment has to be performed in a comprehensible form. The statement power and boundary values of parameters have to be clearly explained and the scope of possible inaccuracies has to be defined, and all the information has to be published in a comprehensible language.

Activities risk assessment should be documented on some of the available media, the most easily by way of questionnaires or protocols that have to include the following entries:

- Title page
- Summary of the problem
- Contents
- Goal and significance of the analysis
- Limitations, presuppositions and reasoning of limitations
- Description of the system and its functional structures
- Description of the used method of risk analysis
- Results of the hazards identification
- Definition of hazardous situations
- Description of the used models (in case they have been used)
- Summary of essential information and its sources
- Risk evaluation
- Proposal of methods for risk management

In case the risk assessment is a part of a continuous process of work safety management, it has to be performed in a way that during all the technical life of a technological system, installation, or during whole period of operating, the most modern procedures will be used and current information will be at disposal, and at the same time it will be carried out after every technical or personnel change undertaken in the man–machine–environment system.

Procedures for Performance of the Risk Analysis

The following conditions are a base for selection of a method for risk analysis and assessment:

- The method has to be scientific and it has to comply with the analyzed system
- The results of the assessment have to be in a form that enables describing the risk in a comprehensible way and proposing arrangements for its minimalization
- It has to be repeatable, comprehensible, and controllable

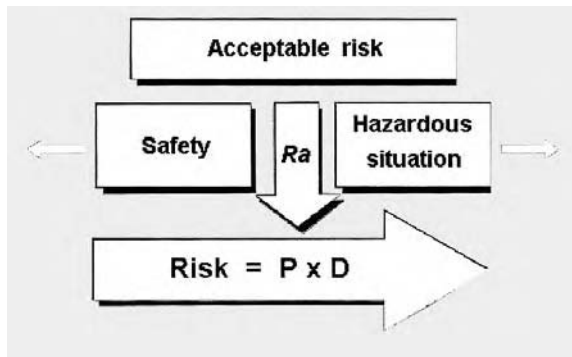

FIGURE 30.5 Significance of acceptable risk.

30.9 Assessment of System Safety

The risk assessment of a chosen system and its ranking into the scale of risks also appoints the criteria of safety of the system being assessed. It is a decision-making step (Figure 30.1, Block 6).

The criteria of the system safety evaluation and qualification of risks come out of the risk boundary value that is considered acceptable. This value is not defined precisely and it is determined by the level of science, culture of work relationships, legislative requirements, operation intensity, etc. (Figure 30.5).

Acceptable risk is understood to be a risk that the involved persons are willing to bear taking into regard all the operation as well as human conditions. The science of technical systems safety and work safety¹¹ proved there is no 100% safety in a functional system; that means there is no zero risk — it only can approach zero.

30.10 Arrangements for Decrease or Elimination of Risk

If the system safety assessment showed that the risk is higher than acceptable, or assessors came to this conclusion by a qualified estimate, it is necessary to suggest arrangements for total elimination or decrease of the risk.

The risk can to be eliminated totally if the hazard was eliminated (e.g., dangerous chemical glue would be replaced by another, harmless one), or if the hazardous situation was eliminated (people and/or technical objects would be excluded from the dangerous space). If there is a hazard in the system being assessed that induces hazardous situation with higher risk than acceptable, it is necessary to suppose that it will cause an injury or damage if no safety arrangements are assumed.

To decrease the risk it is necessary to assign safety arrangements in a careful and professional way. It depends on the invention of people who are to propose them. Two framework procedures can be presented for application in real conditions:

Method of Safety Arrangements Priority

The principle of priority is held when assuming safety arrangements. The arrangements of collective protection are assumed preferentially, and in case it is not possible to achieve it by available means, individual protection succeeds.

Another principle is that risks are decreased preferentially by design and project solutions. If the required level of safety has not been achieved, the use of safety arrangements will be suggested. If the protection is not perfect, another step is individual protection of workers and organizational arrangements. Residual risks are solved by safety instructions, operation procedures, and systems of worker training.

Method of Adaptation of Risk Parameters and Risk Factors

The use of this method is advantageous in case the systematic risk assessment has been performed and doing so it is possible to assign from the analysis what mostly influences the risk parameters (probability and consequence of a negative event) as well as the system parameters or risk factors that mostly influence the high value of risk.

The main principle of this method is the change or adjustment of risk factors so the risk is decreased. The priorities of activities system can be summed up into the following procedures:

1. Preferential limitation of risk directly at the source — elimination of danger. (If electricity is the danger in the system, the voltage 220 can be changed to 24 Volts — danger is eliminated. Accordingly, if harmful chemical substance is replaced by harmless.)
2. Possibility of change of the assessed system. (Deceleration, decrease of potential energy, introduction of protective installations, etc.)
3. Minimalization of probability of an undesirable event arising. (Reduction of exposure, attendance training, improvement of maintenance and checks, etc.)
4. Minimalization of consequences of a possible undesirable negative event. (Excluding the endangered persons, introduction of emergency arrangements, etc.)

30.11 Establishment of Priorities

The complex risk assessment will enable ranking the priorities according to importance. The systems with high risk are to be solved immediately. Possible solutions could be to stop the operation, put the machine out of operation, or temporary arrangements.

Acceptable risks should also be included in the framework of performing the arrangements; since they can be even more minimalized, working conditions as well as ambiance can be improved.

In the next step it has to be checked whether the risk would cease at the proposed arrangements. Therefore, it is necessary to carry out the procedure according to the presented algorithm, and to verify whether the residual risk is acceptable.

30.12 Example of Risk Assessment Methods

Combined Procedures

Combined methods for risk assessment consist of two independent procedures that complete each other. The first are the methods for risk identification, and the second methods for risk evaluation.

The record of causal dependence for the observed event in optional form has to include the hazard and hazardous situation description, as well as their resulting appearance — damage. Catalogue pages that are of different form are a typical representative of these procedures.

The evaluation of risk is an independent stage in the process of its assessment. There are various procedures for this purpose from the most simple methods up to complex analytic methods including detailed economic analyses. For the needs of operative risk assessment, a simple point method of risk assessment was chosen — MIL-STD 882C — System safety program requirements.¹²

When selecting the combination of identification method and risk assessment, it is necessary to consider the requirements put on the risk assessment process and further utilization of results.

Catalogue Pages

The term catalogue pages is a form of record of causal dependence for the observed group of risks. In technical practice, it is also possible to meet a term that expresses the description of a certain group of risks in a more appropriate way — cadastre of risks. Catalogue pages have to contain minimum information on the type of hazard, kind of hazardous situation, and its consequence. This information does not have a form laid down by a standard, and it is often completed with other information, e.g., what

standards and regulations concern the observed risk, in which stage of technical life of the installation the observed risk occurs. The most simple way of recording with regard to further utilization is the database record with a precisely selected structure.

Utilization and Goal

The catalogue page can be used from a construction design of the system up to liquidation of the observed system. It can be used easily by projectors, inspection workers, as well as normal operation workers. The goal of the catalogue page is to quickly distinguish possible hazards and hazardous situations in a concrete operation as well as their displays. The catalogue page is a living material, and it is necessary to complete it gradually, which is also shown in Reference 13.

The set of catalogue pages forming a compact cadastre of risks for a specific group of machines or complex technology is extensive material.

Procedure of Catalogue Page Creation

Particular steps for creating a catalogue page consist of:

- Definition of assessed system
- Definition of catalogue page structure (kind and quality of information on causal dependence)
- Definition of structure of the catalogue page record with regard to user's requirements
- Way of completing the catalogue page
- Possibility of gathering catalogue pages into groups in the form of catalogues

Figure 30.6 shows a catalogue page for the group of lifting machines — cranes where there is a type of risk identified (break of suspension device).

Primary information essential for making the catalogue pages contains inspection records, injury records as well as recommendations of producer. The problem of creating the catalogue pages is demanding in time, extent, and quality of information. It is necessary to realize that there is typization, and thus also the possibility to gather single hazards and hazardous situations into groups which reduces the number of catalogue pages.

Summary

The advantage of the catalogue page is its simple usage not demanding special knowledge, usable in all stages of technical life of the observed system. Introduction of identification enables operative interventions from the lowest control levels of the system up to the level of medium risk management. The catalogue page serves as a suitable base for risk evaluation.

Risk Assessment

For an efficient risk assessment process, it is necessary to attach a numeric value to the concrete risk. In general, risk is a function of at least two basic parameters: frequency or probability, and consequence. Other measurable factors like exposure time and possibility of prevention are functions of probability and consequence. Financial expression of consequence appears to be problematic in some systems. It mostly concerns systems with human factors. In systems with insignificant influence of human factors, the consequence can be evaluated in financial units (technical risks).

A special group of risk managers deals with the process of risk evaluation. Basic system steps to creating the system of risk assessment and next management are in standards.^{14,15} One of the partial outputs of these procedures is formation of a risk matrix. The risk matrix expresses double-parametric record of the probability and consequence category. The resulting product of combinations of probability and consequence category expressed by point value of a concrete risk is its ranking into criteria groups. The criteria group assigns the priority of intervention with the goal to minimize the existing risk.

Utilization

Point evaluation of risk can be used in the stage of primary analyses as well as in the stage of detailed analyses. The point risk evaluation in the process of operative risk management in normal operation has

CATALOGUE		Cranes: CODE	
PAGE No.			
TYPE OF RISK:	Break of suspension device		
		RISK DESCRIPTION	
TECHNICAL RISK FACTORS			CODE
- Controlling systems of lifting mechanism - Weight of burden - overloading - Quality of suspension device - obsolescence, corrosion			
ARRANGEMENTS FOR RISK TREATMENT	CODE	RESIDUAL RISK	CODE
- Prohibition of operating Regular check and maintenance of suspension device - Continuous management of speed		- Uncontrolled material damage - Human factor - Time intervals of maintenance	
HUMAN FACTOR INFLUENCE ON RISK			CODE
Craner: - performance of prohibited activity - check and maintenance in contradiction with technological regulations			
CONTIGUOUS DOCS (Norm, style, code, commendations)			CODE
STN 27 10 43 - par. 72, letter. P; par. 90 EN 292-1,2 - Mechanical risk SRE 89/ 392/ EWG - Appendix I, Chap. 1, par. 1.3.3. - Hazards due to falling burden Chap. 4, par. 4.1.2.7. - Hazards due to burdens transfer DIN 15003 - Lifting machines - Suspension devices VBG 9a - Suspension devices at lifting machines operation VDI 2414 - Hanging of burdens			

FIGURE 30.6 Catalogue page.

minor demands on theoretical knowledge, but, on the other hand, it requires perfect knowledge of the assessed technology since the assessor has to rank the probability and consequence into particular categories.

Risk Matrix

The risk matrix is formed by the combination of probability categories (Table 30.7) and consequence categories (Table 30.8). The risk matrix is shown in Table 30.9.

Risk matrices based on a simple definition of risk fulfill the following general principles:

- Risk matrix is of a line form where single lines express the level of risk
- Individual linguistic variables describing the category of defined level of statement value
- The consequence value should have the dimension of standard hour, cycles, financial dimension; by checkback it is possible to define in a more accurate way particular linguistic variables or number sets related to them

The above-described point method recognizes four levels of risk in the range of 20 points. The risk level enables us to accept concrete arrangements leading to risk minimalization.

The example of risk matrix use in the risk management process is, e.g., formation of responsibility hierarchy for the arrangements by appropriate organ and responsible worker for the risk assessment (Table 30.10).

TABLE 30.7 Probability Chart

Type	Level	Description for Event	Description Generally
frequent	A	it will probably arise often	continuously expected
probable	B	it will arise several times during life-time	frequent
occasional	C	it will arise occasionally during life-time	several times
rare	D	little probable, but possible	is expected seldom
improbable	E	almost excluded	possibly very seldom

TABLE 30.8 Chart of Consequences

Type	Category	Description
catastrophic	I	death or loss of system
critical	II	severe injury, illness, or extensive system spoliation
marginal	III	lighter injury, illness, or smaller spoliation of system
negligible	IV	less than lighter injury, negligible system failure

TABLE 30.9 Resulting Matrix of Numeric Risk Assessment

Probability/consequence	Risk Matrix			
	I Catastrophic	II Critical	III Marginal	IV Negligible
A frequent	1,00	3,00	7,00	13,00
B probable	2,00	5,00	9,00	16,00
C occasional	4,00	6,00	11,00	18,00
D rare	8,00	10,00	14,00	19,00
E improbable	12,00	15,00	17,00	20,00

Point Value	Risk Level
1–5	unacceptable
6–9	undesirable
10–17	acceptable with examinations
18–20	acceptable without examinations

TABLE 30.10 Ranking the Risk into Groups

Probability/Consequence	Risk Matrix			
	I Catastrophic	II Critical	III Marginal	IV Negligible
frequent	high risk	high risk	high risk	medium risk
probable	high risk	high risk	medium risk	low risk
occasional	high risk	high risk	medium risk	low risk
rare	high risk	medium risk	low risk	low risk
improbable	medium risk	low risk	low risk	low risk

Risk Level	Responsible Organ
high risk	main authorized person
medium risk	program authorized person
low risk	program engineer

The risk matrix can also be used for the creation of the risk rate analysis program. It is a matter of general principle that the lower the point risk value, the more necessary is detailed risk analysis.

The risk matrix can be used in the process of the proposal of acceptable risk borders. From the point of view of system safety, it is necessary to define the conditions regarded to be unacceptable, and when they occur, an intervention is necessary with the aim of minimalization of the risk to an acceptable level. In general, unacceptable conditions include:

- Failure of a elementary component, human fault, or construction characteristics that might cause an accident with critical or catastrophic relevance
- Dual failure of independent components, dual human fault, or their combination also including an incorrect command or check function that might cause a negative event with critical or catastrophic relevance
- Generation of dangerous radiations, e.g., ionizing radiation, if arrangements for protection of people or sensitive installation are not carried out
- Manipulation processes that might cause an accident to unprotected persons and installations
- Risk categories that are specified in contract as unacceptable. The other conditions are regarded as acceptable and they do not require further analysis once they are checked and verified.
- System structure that requires two or more independent human faults or failures or their combinations
- System structures that positively create fault prevention
- System structures that positively prevent spoliation of one part by another
- Limitations of system structure in operation, interaction, or linkage that precedes the failure arise
- System structures that provide improved safety factor, or they keep it at acceptable level
- System structures where energetic flows might cause a failure, e.g., valves
- System structures where a failure in one part can be temporarily tolerated since residual strength or function complies with safety conditions
- System structures where the attendance can manage a risk situation according to the assumption
- System structures bordering or checking the use of dangerous materials

The next example shows the procedure of a human risk evaluation by way of application of the point method in the man-machine-environment system represented by a lifting machine (bridge crane). A similar analysis of injuries regarding the classification of injuries can be found in Figure 30.7.

With regard to the types of risks defined in Reference 16, hazards and mechanical hazardous situations creating the risk have been analyzed in a more detailed way. Figure 30.8 presents the percentage representation of individual kinds of injuries caused by mechanical parts of the crane for particular parts of a human body.

The injury percentage does not provide a sufficient answer to the question about the height of particular risks. Only hazard and hazardous situations are sufficiently defined. The definition of consequences and their evaluation enables one to assess the height of risk.

Table 30.11 presents the categories of probability and consequence. Graphic display of particular risks is presented in Figure 30.9.

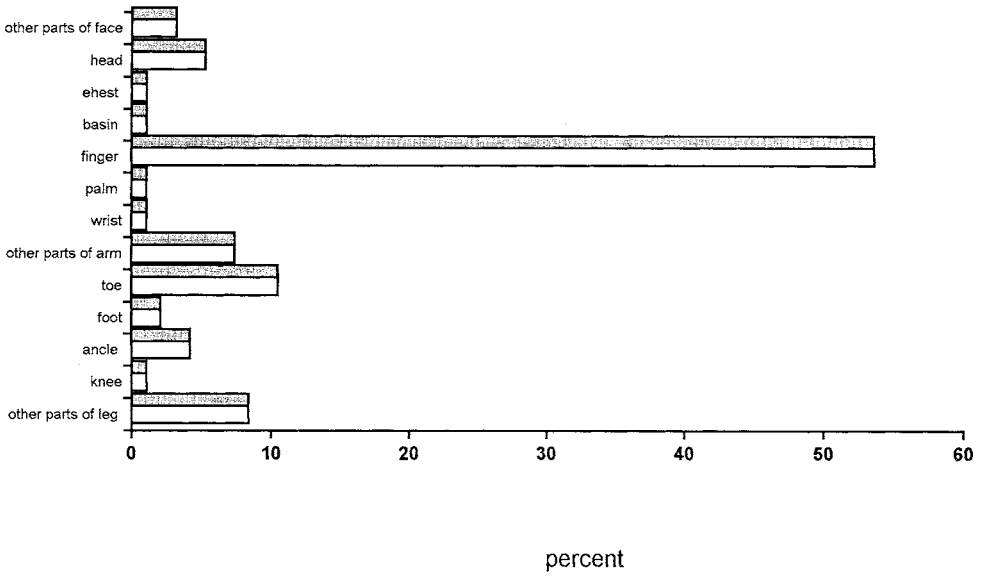

FIGURE 30.7 Analysis of risks in bridge crane operation.

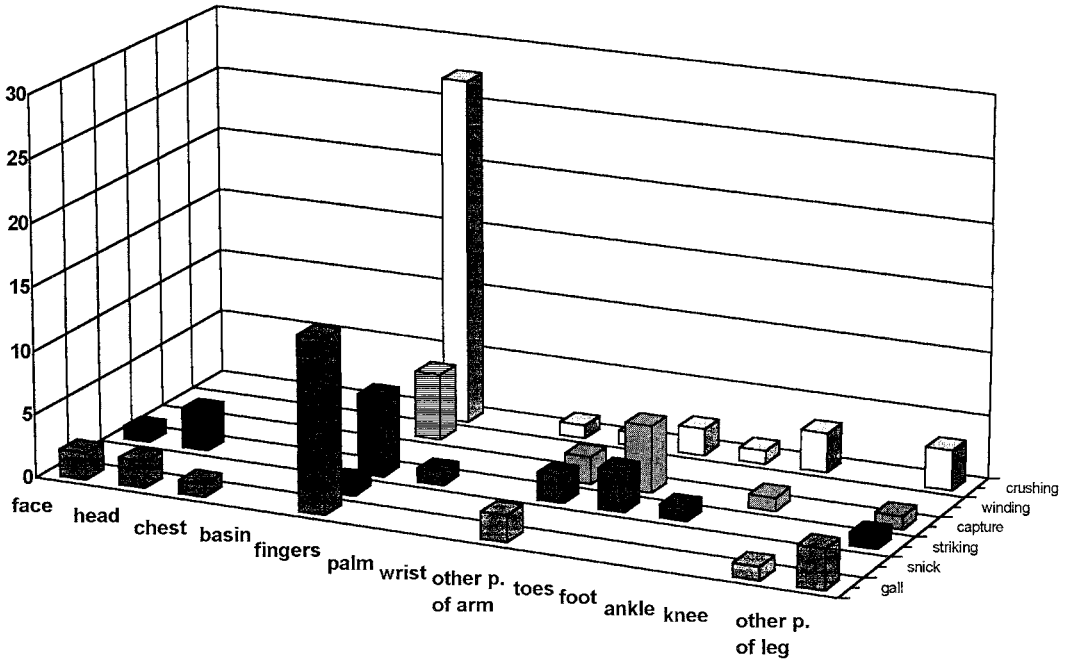
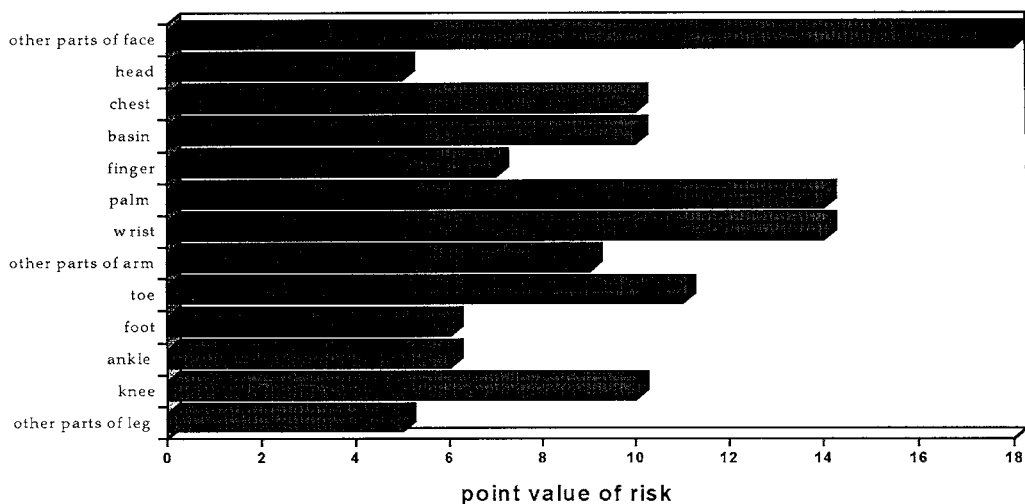

FIGURE 30.8 Injuries caused by mechanical parts of bridge crane.

TABLE 30.11 Risk Assessment

Part of Body	%	Probability Categ.	Conseq. Categ.	Point Method Point Value of Risk	Risk Level
other parts of face	3.20	C	IV	18,00	acceptable without examinations
head	5.30	B	II	5,00	unacceptable
chest	1.10	D	II	10,00	acceptable with exam.
basin	1.10	D	II	10,00	acceptable with exam.
fingers	53.70	A	III	7,00	undesirable
palm	1.10	D	III	14,00	acceptable with exam.
wrist	1.10	D	III	14,00	acceptable with exam.
other parts of arm	7.40	B	III	9,00	undesirable
toes	10.50	B	III	9,00	undesirable
foot	2.10	C	II	6,00	undesirable
ankle	4.20	C	II	6,00	undesirable
knee	1.10	D	II	10,00	acceptable with exam.
other parts of leg	8.40	B	II	5,00	unacceptable



1-5 unacceptable 10-17 acceptable with examinations
 6-9 undesirable 18-20 acceptable without examination

FIGURE 30.9 Graphic display of risk levels.

References

1. Majer, I., Sinay, J., Oravec, M., Posudzovanie rizik — východisko k účinným bezpečnostným opatreniam/slov. Výskumný a vzdelávací ústav bezpečnosti práce SR, 1997.
2. Defren, W., Qualitätsmanagement — Strategie bei der Risiko-Analyse im Maschinenbau/ger. Prednáška na konferencii A+A, 1995, Düsseldorf.
3. Hoor, M., Umsetzung einer Gefährdungsanalyse am Beispiel "Stahlwerke."/ger. *Moderne Unfallverhütung*, Heft 36, str.: 33-42 ISSN 0544-7119.
4. Nohl, J., Thiemeck, H., Durchführung von Gefährdungsanalysen -Teil/ger. Schriftenreihe der BAA, Dortmund, 1988.
5. Meisebach, J., Strategie und Praxis wirksamer Sicherheitsarbeit/ger. Papiermacher BG, Mainz, 1988.

6. Schneider, B., Motivation der Arbeitnehmer und Führungskräfte durch Ausbildung während des Übergangs der Belegschaft von Kokilen — zum Stranggiesverfahren/ger. Düsseldorf/Duisburg, 1986.
7. Merz, A.-H., Schneider, T., Bohnenblust, H., Bewertung von technischen Risiken/ger. ETH Zürich — vdf Hochschulverlag AG., 1995 ISBN 3-7281-2178-9.
8. Haibach, E., Betriebsfestigkeit/ger. VDI-Verlag Düsseldorf, 1989, ISBN 3-18-400828-2.
9. Strnad, H., Vorath, B.-J., Sicherheitsgerechtes Konstruieren/ger. Verlag TÜV Köln, 1992.
10. Kreuzkamp, F. Meffert, K., Risiken in Steuerungen — Grundlagen der Klassifizierung/ger. Moderne Unfallverhütung, 34, str.: 16-20, ISSN 0544-7119.
11. Kuhlmann, A., Einführung in die Sicherheitswissenschaft/ger. Verlag TÜV Rheinland, Köln, 1981, ISBN 3-528-08495-2.
12. Kuhlmann, A., MIL-STD 882C — System safety program requirements APR 1993, U.S.A.
13. Kuhlmann, A., STN-EN 292.1 — Bezpečnosť strojných zariadení, základné pojmy, všeobecné zásady navrhovania/slov ÚNMS SR Bratislava, Slovakia 11/96.
14. Kuhlmann, A., pr. EN 954-1 — Sicherheit von Maschinen — Sicherheits- bezogene Teile von Steuerungen, Teil 1 — Allgemeine Gestaltungsleitsätze/ger. Beuth-Verlag, Berlin, 1993.
15. Kuhlmann, A., DIN IEC 65A 123 — Funktionelle Sicherheit von elektrischen Systemen — Allgemeine Aspekte/ger. Beuth-Verlag, Berlin, 1992.

Section III Service Systems

31

Ergonomics in Health Care Organizations

31.1	Introduction	31-1
	Health Care Is a Large and Diverse Industry • Ergonomics Creeps into Health Care • Common Injuries and Illnesses	
31.2	Fundamental Concerns of Health Care Sectors	31-3
	Hospitals • Nursing Homes • Home Nursing • Dental Offices • Medical Devices and Equipment	
31.3	Ergonomics Programs in Health Care	31-7
	Example 1 • Example 2	
31.4	Elements of Ergonomics Programs in Health Care.....	31-8
31.5	Summary	31-9

Roger C. Jensen
UES, Inc.

31.1 Introduction

The methods and tools of ergonomics apply to the health care industry. This chapter provides background information on the health care industry, discusses injury and illness concerns of different industry sectors, and summarizes examples of ergonomics programs in health care. The chapter concludes with a discussion of elements of ergonomics programs in health care organizations.

Health Care Is a Large and Diverse Industry

National health care programs in many countries provide most health care through public institutions. In the United States, both public and private institutions provide health care. These health care providers include hospitals, nursing homes, home health care organizations, medical offices, and dental offices.

Health care providers are classified by the type of services provided. In the United States the Standard Industrial Classifications (SIC) for health care consists of the sectors identified in Table 31.1. Variations on the categories may be found in other countries.

Employment in the private sector health care industry makes up 10.4% of all employment in the United States.¹ Of the sectors listed in Table 31.1, hospitals employ the most people, followed by nursing and personal care facilities.

The hospital sector includes the subsectors: general medical and surgical hospitals, psychiatric hospitals, and specialty hospitals. The nursing and personal care sector includes the subsectors: skilled nursing care facilities, intermediate care facilities, and nursing and personal care facilities not elsewhere classified.

¹Based on the 1990 census of the population, U.S. Bureau of the Census. Persons employed in the health services: 9,682,684. Persons employed in all private sector establishments: 95,449,300.

TABLE 31.1 Health Care Industry Sectors in the United States

SIC Number	Description of Industry Sector
801	Offices and clinics of Doctors of Medicine
802	Offices and clinics of Dentists
803	Offices and clinics of Doctors of Osteopathy
804	Offices and clinics of Chiropractors, Optometrists, Podiatrists, and other health practitioners
805	Nursing and personal care facilities
806	Hospitals
807	Medical and dental laboratories
808	Home health care services
809	Other health and allied services

From U.S. Office of Management and Budget, Standard Industrial Classification Manual 1987. U.S. Government Printing Office, Washington, D.C.

Within the nursing and personal care sector, approximately 70% of employment is in skilled nursing care facilities. As a result, the nursing and personal care sector is often referred to as the nursing home sector.

Ergonomics Creeps into Health Care

The health care industry has been a follower, not a leader, in applying ergonomics. Applications of ergonomics to aircraft design took hold during the 1940s, and expanded significantly during the 1950s and 1960s (Grether, 1986). These applications emphasized design to enhance crew performance. Applications of ergonomics in the automobile industry initially focused on product design to improve comfort and enhance driver performance. During the 1970s, a few automobile manufacturers started applying ergonomics to production operations. Joint labor–management ergonomics programs spread throughout the automobile manufacturing companies during the 1980s (Joseph and Jimmerson, 1996). Companies that supply parts to automobile manufacturers implemented similar programs during the early 1990s. These applications addressed employee safety, health, and comfort. In contrast, the health care industry showed limited interest in ergonomics prior to the 1990s.

For many years the health care industry has been aware of a back injury problem among nurses. Throughout the 1960s and 1970s, numerous articles in nursing magazines showed widespread concern for the high incidence of sprains and strains among nurses (Jensen, Nestor, Myers, and Rattiner, 1988). The articles also reflected an apparent acceptance of the belief that low back sprains and strains occur most often while performing patient-handling tasks (Jensen, 1985). Most authors advised nurses to avoid low back injury by maintaining personal fitness and always using proper body mechanics when transferring patients. Prior to 1980, authors of articles about back pain among nurses failed to mention the ergonomics approach of changing task demands to fit the capabilities and limitations of the nurses (Jensen et al., 1988).

During the 1980s, concern about back injuries among nurses continued. Other health care occupations also started receiving attention — particularly nursing assistants who work in nursing homes (Gagnon and Lortie, 1987; Jensen, 1987) and geriatric hospitals (Lortie, 1985, 1986). Several studies were published reporting increased back injury risk with increased exposure to patient handling (Jensen, 1990a).

Common Injuries and Illnesses

Injury and illness rates provided in Table 31.2 show that the extension of concerns beyond hospitals was fully justified. The rates are for injuries and illness that resulted in an employee being unable to work for a day or more. Each rate uses the same denominator, 10,000 full-time equivalent employees working for one year. The name for this is “days-away-from-work case rate.” Rates in Table 31.2 apply to the year 1994 in the United States. Rates are not published for the sectors consisting primarily of small offices and clinics of dentists, osteopathic physicians, chiropractors, optometrists, and podiatrists – SIC 802, 803, 804.

TABLE 31.2 Rates for Days-Away-From-Work Cases in 1994 for All Industries and for Sectors of the Health Care Industry

Industry Sector	Overall Rate	Sprain & Strains	Carpal Tunnel Syndrome	Tendonitis
All industries combined	277.0	119.3	4.8	3.1
Offices and clinics of medical doctors	53.5	22.6	2.7	1.2
Nursing and personal care facilities	633.5	366.7	1.9	3.3
Hospitals	326.4	119.1	3.0	2.1
Home health care services	473.6	279.8	2.7	2.2
Other health and allied services	217.9	107.4	5.2	2.4

From U.S. Bureau of Labor Statistics. Annual Report on Workplace Injuries and Illnesses, 1994. Table 6.

The first row of data in Table 31.2 shows the 1994 rates for all industries combined. Rates for all types of injuries and illnesses, in the first column of data, indicate that the overall rate for all industries combined was 277. This rate was exceeded by nursing and personal care facilities, by hospitals, and by home health care services. For sprain and strain type injuries, the rate in nursing and personal care facilities was three times greater than for all industries combined. The rate of sprain and strain injuries in hospitals was no different from the rate for all industries combined.

For the carpal tunnel syndrome data shown in Table 31.2, the rate for all industries combined (4.8) was greater than that for each health care sector, except "Other health and allied services." The elevated rate for "Other health and allied services" was probably due to employment of large numbers of people who perform highly repetitive manual work such as medical transcribers and clerical personnel using computers to process insurance, billing, and medical records. For tendonitis, the rate for all industries combined (3.1) exceeded the rate for each of the health care sectors, except nursing and personal care facilities (3.3).

31.2 Fundamental Concerns of Health Care Sectors

The data in Table 31.2 show the large differences in days-away-from-work case rates among sectors of the health care industry. Each sector has some unique safety and health concerns. The following sections summarize some issues and literature unique to specific sectors of the health care industry.

Hospitals

Analyses of hospital injury records have identified the nursing department as a major concern. Hoover (1973) reported that of 85 lifting injuries, the nursing service contributed 43%, followed by housekeeping with 13%. Hublely-Kozey, Westers, Stanis, and Wall (1985) reported that of 171 back injuries, nursing personnel incurred 60%, and 70% of these occurred on the nursing wards. Lewy (1981) reported that nurses accounted for 59% of injuries even though they represented only one-third of the hospital workforce.

Back injuries have plagued hospital nurses for years. Nurses who suffer back injuries generally associate the injury with a patient-handling task (Jensen, 1985).

Nurses are not the only hospital employees with injuries. An analysis of injury and illness records of a large hospital in Israel found that most cases were among the housekeeping, maintenance, laundry, and catering workers (Pines, Cleghorn de Rohrmoser, and Pollak, 1985).

Nursing Homes

Sprains and strains accounted for 58% of the days-away-from-work cases in nursing and personal care sector, according to the 1994 data in Table 31.2. Sprains and strains accounted for 68% of the workers' compensation claims in nursing and personal care facilities, according to data for the year 1986 (Jensen, 1990b). The rate for sprains and strains in nursing and personal care facilities was three times that of all industries combined (Table 31.2).

Of the sprain and strain compensation claims reviewed by Jensen (1990b), 56% were for back injuries. Data in Table 31.2 indicate that the nursing and personal care sector had a lower rate of carpal tunnel syndrome than the other health care sectors, and lower than the rate for all industries. From all these data it is concluded that nursing and personal care facilities have a major problem with back sprains and strains, and comparatively little concern about carpal tunnel syndrome.

Home Nursing

Injury data from two home health care agencies were examined by Myers, Jensen, Nestor, and Rattiner (1994). They collected injury records for home health aides and a comparison group – nursing assistants and orderlies working in a large hospital. Back injury rates of the home health aides were almost three times that of the comparison group. For the home health aides, 64% of the activities associated with low back injuries involved patient handling. The specific patient handling activities that comprised the 64% were:

- Moving patient up in bed (21%)
- Helping patient in or out of bed (11%)
- Helping patient in or out of chair (9%)
- Catching patient starting to fall (9%)
- Helping patient in or out of tub (5%)
- Turning patient in bed (4%)
- Helping patient from bed (2%)
- Helping patient on or off toilet (2%)

Ergonomics has not been applied, to a significant extent, to the work of home health aides. Their needs are different from corresponding workers in institutional settings (Owen, 1996). One difference is that most beds in health care facilities are adjustable in height. Most home patients have beds that are not adjustable in height. A low bed height means the health care provider must bend more to care for the patient, and the bending means more stress on the lower back.

Patient lifting equipment for the home needs to be usable by one care provider, whereas in nursing homes, nursing assistants generally work in pairs. Some home patients have beds with insufficient space underneath for the legs of a portable hoist. Therefore, patient transfers must be performed without a hoist.

Another difference is the matter of responsibility for providing patient-lifting equipment and other patient-handling devices. The visiting care provider can bring some patient-handling devices into the home during each visit. Examples are walking belts and sliding boards. Portable patient hoists are too bulky and heavy to carry around from home to home on a daily basis. It is far more practical to have the patient lease or buy a hoist that can be kept in the home. Some home nursing organizations lease hoists to patients. By leasing, the home nursing organization controls the brands and models of hoists. In contrast, hoist selection by the patient or a family member may not consider characteristics such as difficulty of use, suitability for the patient's needs, or safety characteristics like stability.

Owen (1996) discusses a variety of devices that can be helpful for patient handling in the home. Devices discussed include: portable patient hoists, portable stand-assist lifts, transfer boards, portable commodes, chairs and cushions that lift, lift poles, riser attachment for toilet bowls, hospital type beds, and ceiling mounted hoists. Before selecting devices, the home care organization conducts a patient assessment. Part of the assessment addresses patient-handling devices that match the patient's needs. The assessment findings need to be clearly communicated to the home health aide, and the aide must be trained to properly use the patient-handling devices selected for the patient.

Dental Offices

Literature on the occupational injury and illness problems in dental offices reflects little concern about sprains and strains. There have, however, been some reports of disorders associated with maintaining awkward postures for extended periods of time, e.g., Adelman and Elsner (1982).



FIGURE 31.1

Dentists tend to work in static postures with low intensity muscle contraction. The photograph of a dentist in Figure 31.1 illustrates a working posture requiring constant tension of neck and shoulder muscles. His spine is rotated and his back muscles are tensed to maintain his head position.

In a study of postures during common dental procedures, Finsen and Christensen (1994) found that the eight dentists studied spent 82% of their time with their neck flexed more than 30 degrees, and they spent about 30% of their time working with their arms abducted more than 30 degrees. These times, however, include only direct patient care time. The periods between direct patient care allow some time for fatigued muscles to recover.

Data from several surveys indicate that dentists tend to suffer from musculoskeletal complaints (Shugars, Miller, Williams, Fishburne, and Strickland 1987; Murtomaa, 1982; Lehto, Helenius, and Alaranta, 1991). Representative findings from a survey of dentists in Denmark (Christensen and Finsen, 1994), were:

- 54% reported trouble with their neck muscles during the past year. (This 54% prevalence may be compared to prevalence rates for neck troubles in the general working population in Denmark of 49% for females and 28% for males.)
- 59% reported low back trouble
- 39% reported shoulder trouble
- 20% reported trouble with their hands

Dental hygienists have also been studied. Their work tends to involve low load, static contraction of the trapezius muscles and other muscles that hold joints in fixed position. During patient care, these periods of static contraction are interrupted occasionally with rest pauses of about one-second duration (Öberg, Karsznia, Kadefors, and Sandsjö, 1994). Figure 31.2 shows a dental hygienist working in a posture



FIGURE 31.2

that requires sustained tension of the right shoulder muscles to support her abducted arm, and neck muscles to support the weight of her head. Her left wrist is extended and in ulnar deviation while using the instrument to scale the patient's teeth.

In a survey of Danish dental hygienists, 62% reported having neck complaints during the past year and 81% reported shoulder complaints (Öberg and Öberg, 1993). Both prevalence rates were considerably greater than those of the general Danish population of working women.

Some dental hygienists develop carpal tunnel syndrome. While scaling teeth, hygienists exert force with their dominant hand, often with the wrist deviated considerably from the neutral posture. A survey of Canadian dental hygienists found that 7% had been told by a physician since starting work that they had carpal tunnel syndrome (Liss et al., 1995).

Medical Devices and Equipment

While the most widely recognized application of ergonomics in health care is for employee injury prevention, a less recognized area is for the design of medical devices. A full review of these applications is beyond the scope of this handbook, but to illustrate the range of applications, some recent ergonomics contributions are listed below. These were published in an issue of *Human Factors* – the journal of the Human Factors and Ergonomics Society.

- Design of instructions for medication (Morrow et al., 1996)
- How users cope with poorly designed computer interfaces (Obradovich and Woods, 1996)
- Adapting to new technology in the operating room (Cook and Woods, 1996)
- Accuracy of pharmacists' prescriptions as affected by ambient noise (Flynn et al., 1996)

- Evaluation of self-reporting of deficiencies in airway management (MacKensie et al., 1996)
- Task complexity in emergency medical care (Xiao et al., 1996)

31.3 Ergonomics Programs in Health Care

Application of ergonomics in health care has evolved somewhat differently from the growth patterns in other industries. Back injury programs in hospitals have traditionally been initiated by nursing departments, sometimes in conjunction with employee health and physical therapy departments. Some of these programs only applied to nursing departments.

Historically, back injury prevention programs placed considerable emphasis on instruction of nursing staff on personal physical fitness, proper techniques for manually transferring patients, and case management. Case management in these programs was a process of monitoring rehabilitation and facilitating the earliest practicable return to work of employees who suffer from back pain (Wood, 1987). Early return to work has traditionally meant accommodating a worker with lifting restrictions by temporarily omitting job duties that require lifting more than the restricted weight. These methods for controlling back injuries are not mainstream ergonomics. The process becomes ergonomics when the method for performing the lifting tasks is changed so the individual can perform it.

The introduction of a greater emphasis on changing the task demands for nurses appears to have evolved in the United Kingdom during the 1980s. Various types of patient-handling equipment were evaluated (Bell, 1984). Techniques for patient transfers were compared (Stubbs, Buckle, Hudson, and Rivers, 1983). Various surveys were conducted, e.g., Stubbs, Buckle, Hudson, Rivers, and Worringham (1983). These findings were incorporated into the second edition of *The Handling of Patients: A Guide for Nurses*, 2nd ed. (Lloyd, Tarling, Troup, and Wright, 1987). The book included traditional methods of using proper body mechanics, but it emphasized the use of patient-handling equipment. This was a major departure from the first edition and from traditional nursing instruction that only addressed proper body mechanics.

Two examples of ergonomics programs in health care are described below. They are presented in order of time.

Example 1

A paper by Aird, Nyran, and Roberts (1988) describes an ergonomics program implemented by a medium-size nursing home in Ontario, Canada. Included in the intervention program were the following:

- An assessment of each lift required for each resident, taking into account caregiver capabilities, resident characteristics, environmental factors, and the availability of patient-handling devices
- Communicating through a set of logos the proper procedure for performing specific patient transfers
- Obtaining additional lifting devices

Program evaluation was based on the number of reported back injuries associated with patient contact. In the year preceding the intervention there were three. During the year of intervention there were four. In the two years after intervention there were two back injuries reported each year. This illustrates one of the difficulties encountered when trying to evaluate effects of an injury prevention program in a workplace. Injury reports provide an obvious measure, but their occurrence is affected by factors unaccounted for by the intervention. In this instance, Aird et al. (1988) noted that the four post-intervention back injury reports consisted of two from employees regarded as discipline problems, and two reports from an employee with an underlying non-work-related injury. An important lesson learned from this intervention project was that reported back injuries are fine as one measure of intervention effectiveness, but other measures to supplement injury reports are advisable.

Example 2

Garg and Owen (1992, 1994) reported results of an ergonomic intervention program in a nursing home. The National Institute for Occupational Safety and Health sponsored the intervention to demonstrate how ergonomics could change back-stressing tasks performed by nursing assistants. As a first step Garg and Owen had the nursing assistants rate the stressfulness of their various tasks to their lower back, upper back, shoulders, and whole body. These ratings were used to identify the tasks considered most stressful. The most stressful tasks for the lower back were transfers of the nursing home residents, in both directions, between wheelchair and toilet, between wheelchair and bed, and between wheelchair and bathtub.

Before starting the intervention, an ergonomic evaluation of the work performed by the nursing assistants was completed (Garg, Owen, and Carlson, 1992). Alternative approaches for making the transfers were investigated. Different brands of equipment and techniques were compared in a laboratory setting (Garg, Owen, Beller, and Banang, 1991a, 1991b).

Implementation began after the best alternatives were known. The alternatives were based on the capabilities of each resident. For example, residents who could not bear their own weight were transferred using a portable hoist. Many of the stressful transfers were eliminated. One example was the use of a shower instead of a bathtub for certain residents. They were transported to the shower on a portable shower chair, and washed with a flexible shower hose while remaining in the chair. Stressful tasks that could not be eliminated were made less stressful by introducing ergonomic belts that were put around the resident's waist before a transfer. These belts had loops on the sides and back for the nursing assistants to hold during transfers. Training was provided for the nursing assistants who were to use new equipment and techniques.

Evaluation was based on multiple measures. One measure was acceptability. Monitoring the nursing assistants revealed acceptability rates ranged from 87 to 100%. For those transfers not eliminated, a comparison of exposures before and after the intervention revealed a reduction in the perceived exertion of the low back muscles and a reduction in the biomechanical stresses in the lower backs of the nursing assistants. The back injury rate dropped from 83 to 47 per 200,000 hours.

31.4 Elements of Ergonomics Programs in Health Care

Different authors have different ideas about the elements of effective ergonomics programs in health care settings. This section summarizes the ideas of three authors and concludes with a tabular listing of the elements of an ergonomics program for health care facilities.

A back injury prevention program with an ergonomics emphasis was implemented at the University of Massachusetts Hospital. It focused on back injuries associated with patient handling tasks because such injuries constituted a large portion of the hospital's total injuries. The hospital had 32% of all injuries coming from the nursing department, and many of these were sprains/strains associated with patient handling. From the experiences with this program, Fragala (1994) suggests that hospitals include the following five phases in a back injury program with an ergonomics emphasis.

1. Risk identification and assessment.
2. Risk analysis.
3. Formulation of recommendations.
4. Implementation of recommendations.
5. Monitoring and evaluation.

Notice that these phases do not expressly mention the medical processes of health surveillance and medical-case management. Also, training is not identified as a separate phase. However, health surveillance is the core of the second phase, and Fragala sees medical management and training as being incorporated into Phase 4 — implementation of recommendations. Thus, the Fragala model stresses the parts of an ergonomics program aimed at changing the high-risk tasks by making appropriate equipment

TABLE 31.3 Elements of Ergonomics Programs in Health Care Establishments

Ergonomics Committee Effectiveness	Processes to Affect Working Conditions	Processes to Reduce Lost Time
Management commitment	Hazard identification	Case management
Supervisory support and participation	Evaluation of risk	Rehabilitation program
Worker support and participation	Hazard control identification	Job descriptions with physical demands
Employee Health Dept. and/or Occ. Med. participation and support	Implementation approval and support	Policy for job modifications to facilitate early return to work
Committee leadership	Funding for changes	Monitoring
Training for committee members	Implementation	Evaluation
Written plan with realistic goals and delegation of work	Monitoring	
Performance evaluation	Evaluation	

available. He sees medical management as an already established program within the hospital that complements the ergonomics program.

MacLeod (1994) presented the following list as the elements of an ergonomics program for a hospital:

1. Organization
2. Training
3. Communication
4. Job Analysis
5. Job Improvements
6. Medical Management
7. Monitoring Progress

Garg and Owen (1994) presented a list of elements they found effective for their ergonomics program in a nursing home.

1. Secure management commitment
2. Enlist worker participation
3. Determine patient characteristics
4. Select and order equipment
5. Train nursing personnel
6. Gather feedback
7. Determine effectiveness

The three lists of program elements all differ. Much of the difference is due to failure to distinguish among elements of effective committee performance, processes for effecting improvements in working conditions, and processes for reducing lost time. Table 31.3 lists key elements for each of these areas.

31.5 Summary

Data cited in this chapter show how large and diverse the health care industry is. Of the different sectors within the health care industry, nursing homes have the greatest problem with back injuries. Hospitals have problems with back injuries as well, primarily among nursing staff. The home nursing sector has problems with back injuries among home health aides. Compared to back injuries, carpal tunnel syndrome is not a very significant problem in these health care sectors. However, carpal tunnel syndrome is a concern for dental hygienists.

Patient handling is the activity most closely associated with back injuries among nursing personnel. Traditionally, hospitals and nursing homes have attempted to prevent back injuries by emphasizing personal fitness and the use of proper body mechanics when performing patient-handling tasks.

The point is made that ergonomics has not been used in health care as extensively as in some other industries. During the 1980s ergonomics began getting recognition as a useful means of reducing the stresses imposed on the backs of nursing personnel when performing patient-handling tasks. A demonstration project in one nursing home showed how stressful patient-handling tasks can be eliminated or made less stressful.

Elements of ergonomics programs for health care facilities are discussed. A summary of elements is provided in a table arranged into three groups:

1. Elements of effective ergonomics committees
2. Processes to bring about improvements in working conditions
3. Processes to reduce lost time

References

- Adelman, S. and Elsner, K. 1982. Arm pain in a dentist; pronator syndrome, *J. Am. Dental Assoc.* 105: 61-62.
- Aird, J.W., Nyran, P., and Roberts, G. 1988. Comprehensive back injury program: an ergonomics approach for controlling back injuries in health care facilities, *Trends in Ergonomics/Human Factors V*, Ed. F. Aghazadeh, 705-712. Elsevier (North-Holland Div.), Amsterdam.
- Christensen, H. and Finsen, L. 1994. Musculoskeletal disorders among dentists and lack of variation in the dental work, *Proceedings of the Triennial Congress of the International Ergonomics Association, Volume 2*, Ed. R. Norman, p. 105-107. Human Factors Association of Canada, Mississauga, Ontario, Canada.
- Cook, R.I. and Woods, D.D. 1996. Adapting to new technology in the operating room, *Human Factors* 38(4): 593-613.
- Finsen, L. and Christensen, H. 1994. Postural loads in the neck and shoulder region during dental work, in *Proceedings of the 12th Triennial Congress of the International Ergonomics Association, Volume 2*, Ed. R. Norman, p. 102-104. Human Factors Association of Canada, Mississauga, Ontario, Canada.
- Flynn, E.A. et al. 1996. Relationships between ambient sounds and the accuracy of pharmacists' prescription-filling performance, *Human Factors* 38(4): 614-622.
- Fragala, G. 1994. Applying ergonomics to back injury prevention programs in health care, in *Ergonomics in Health Care Facilities*, Ed. K.M. Tomasik, p. 7-14. Joint Commission on Accreditation of Healthcare Organizations, Oakbrook Terrace, IL.
- Gagnon, M. and Lortie, M. 1987. A biomechanical approach to low-back problems in nursing homes, in *Trends in Ergonomics/Human Factors IV*, Ed. S.S. Asfour, p. 795-802.
- Garg, A. and Owen, B.D. 1992. Reducing back stress to nursing personnel: an ergonomic intervention in a nursing home, *Ergonomics* 35: 1353-1375.
- Garg, A. and Owen, B.D. 1994. An ergonomic approach to preventing back injuries from patient lifting, in *Ergonomics in Health Care Facilities*, Ed. K.M. Tomasik, p. 15-22. Joint Commission on Accreditation of Healthcare Organizations, Oakbrook Terrace, IL.
- Garg, A., Owen, B.D., and Carlson, B. 1992. An ergonomic evaluation of nursing assistants' job in a nursing home, *Ergonomics* 35: 979-995.
- Garg, A., Owen, B.D., Beller, D., and Banaag, J. 1991a. A biomechanical and ergonomic evaluation of patient transferring tasks: bed to wheelchair and wheelchair to bed, *Ergonomics* 34: 289-321.
- Garg, A., Owen, B.D., Beller, D., and Banaag, J. 1991b. A biomechanical and ergonomic evaluation of patient transferring tasks: wheelchair to shower chair and shower chair to wheelchair, *Ergonomics* 34: 407-419.
- Grether, W.F. 1986. The genesis of human engineering, *Aviation, Space, and Environmental Medicine*, 57(10, Suppl.): A37-43.
- Hoover, S.A. 1973. Job-related back injuries in a hospital, *American J. of Nursing* 73: 2078-2079.

- Hubley-Kozey, C.L., Westers, B.M., Stanis, W.D., and Wall, J.C. 1985. An investigation into the incidence of low back pain in hospital workers, *The Nova Scotia Medical Bulletin* 64(1): 8-10.
- Jensen, R.C. 1990a. Back injuries among nursing personnel related to exposure, *Appl. Occup. and Envir. Hyg.* 5(1): 38-45.
- Jensen, R.C. 1990b. The increasing occupational injury rate in nursing homes, in *Advances in Industrial Ergonomics and Safety Research II*, Ed. B. Das, p. 569-576. Taylor and Francis, London.
- Jensen, R., Nestor, D., Myers, A., and Rattiner, J. 1988. *Low Back Injuries Among Nursing Personnel, An Annotated Bibliography*. Injury Prevention Center, School of Hygiene and Public Health, The Johns Hopkins University, Baltimore, Maryland.
- Jensen, R.C. 1987. Disabling back injuries among nursing personnel: research needs and justification, *Research in Nursing and Health* 10(1): 29-38.
- Jensen, R.C. 1985. Events that trigger disabling back pain among nurses, in *Proceedings of the Human Factors Society 29th Annual Meeting*, p. 799-801. Human Factors Society, Santa Monica, CA.
- Joseph, B.S. and Jimmerson, G. 1996. Development and Implementation of an Ergonomics Process in the Automotive Industry, in *Handbook of Occupational Ergonomics*, Ed. A. Bhattacharya and J. McGlothlin, p. 501-517. Marcel Dekker, New York.
- Lehto, T.U., Helenius, H.Y.M., and Alaranta, H.T. 1991. Musculoskeletal symptoms of dentists assessed by a multidisciplinary approach, *Community Dental Oral Epidemiology* 19: 38-44.
- Lewy, R. 1981. Prevention strategies in hospital occupational medicine, *J. of Occupational Medicine* 23: 109-111.
- Liss, G.M. et al. 1995. Musculoskeletal problems among Ontario dental hygienists, *Am. J. of Independent Med.* 28(4): 521-540.
- Lloyd, P., Tarling, C., Troup, J.D.G., and Wright, B. 1987. *The Handling of Patients: A Guide for Nurses, 2nd ed.* Back Pain Association, Middlesex, England.
- Lortie, M. 1985. L'identification des activités à risque en milieu hospitalier, in *Proceedings of the Human Factors Association of Canada, 18th Annual Meeting*, p. 119-122. Human Factors Association of Canada, Mississauga, Ontario.
- Lortie, M. 1986. Analyse du travail de manutention de patients des aides-soignants dans un hôpital pour soins prolongés, *Le Travail Humain* 49: 315-332.
- MacKensie, C.F. et al. 1996. Comparison of self-reporting of deficiencies in airway management with video analyses of actual performance, *Human Factors* 38(4): 623-635.
- MacLeod, D. 1994. Setting up ergonomics programs in health care organizations, in *Ergonomics in Health Care Facilities*, Ed. K.M. Tomasik, p. 33-38. Joint Commission on Accreditation of Healthcare Organizations, Oakbrook Terrace, IL.
- Morrow, D.G., Leirer, V.O., Andrassy, J.M., Tanke, E.D., and Stine-Morrow, A.L. 1996. Medication instruction design: younger and older adult schemas for taking medication, *Human Factors* 38(4): 556-573.
- Murtomaa, H. 1982. Work-related complaints of dentists and dental assistants, *Int. Arch. Occup. Environ. Health* 50: 231-236.
- Myers, A., Jensen, R., Nestor, D., and Rattiner, J. 1994. Low back injuries among home health aides compared with hospital nursing aides, *Home Health Care Services Quarterly*, 14(2/3): 153-160.
- Öberg, T., Karsznia, A., Kadefors, R., and Sandsjö, L. 1994. Muscular load, fatigue, and pause distribution patterns in dental hygiene: a study with a portable recording and analysis equipment, in *Proceedings of the 12th Triennial Congress of the International Ergonomics Association, Volume 2*, Ed. R. Norman, p. 99-101. Human Factors Association of Canada, Mississauga, Ontario, Canada.
- Öberg, T. and Öberg, U. 1993. Musculoskeletal complaints in dental hygiene. *J. Dental Hygiene* 67, 257-261.
- Obradovich, J.H. and Woods, D.D. 1996. Users as designers: how people cope with poor hci design in computer-based medical devices. *Human Factors* 38(4): 574-592.
- Owen, B.D. 1996. Back injuries in the home health care setting. *Home Health Care Consultant* 3(3): 25-39.
- Pines, A., Cleghorn de Rohrmoser, D.C., and Pollak, E. 1985. Occupational accidents in a hospital setting: an epidemiological analysis, *J. of Occupational Accidents*, 7: 195-215.

- Shugars, D., Miller, D., Williams, D., Fishburne, C., and Strickland, D. 1987. Musculoskeletal pain among general dentists, *General Dentistry* 4:272-276.
- Stubbs, D.A., Buckle, P.W., Hudson, M.P., Rivers, P.M., and Worringham, C.J. 1983. Back pain in the nursing profession: I. Epidemiology and pilot methodology, *Ergonomics* 26: 755-765.
- Stubbs, D.A., Buckle, P.W., Hudson, M.P., and Rivers, P.M. 1983. Back pain in the nursing profession: II. The effectiveness of training, *Ergonomics*, 26: 767-779.
- Wood, D.J. 1987. Design and evaluation of a back injury prevention program within a geriatric hospital. *Spine* 12(2): 77-82.
- Xiao, Y-H. et al. 1996. Task complexity in emergency medical care and its implications for team coordination. *Human Factors* 38(4): 636-645.

32

Ergonomics Efforts in the Package Delivery Industry

32.1	Ergonomics in the Package Delivery Industry	32-1
32.2	Technology-Driven Ergonomic Change.....	32-1
	Current Job and Work Methods • Methodology • Assessment • Training • Surveys • Commitments	
32.3	Workplace Statistics and Job Requirements	32-4
	Overview • Surveys • Potential Solutions • Old Equipment and Method • New Equipment and Method • Results	

Steven W. Thompson
United Parcel Service

32.1 Ergonomics in the Package Delivery Industry

Ergonomics in the service industry, particularly those that are heavily intensive in manual material handling, presents a unique set of challenges in attempting to meet the needs of the office worker as well as the needs of the manual material handlers. This chapter will attempt to answer some of these challenges by discussing:

- A. Technology-driven ergonomic change
- B. Workplace statistics and job-requirement-driven ergonomic change

32.2 Technology-Driven Ergonomic Change

Change, especially technological change, presents an opportunity to enhance a work environment with the proper attention to ergonomics and the impact that it can have on the changing job. The following case illustrates this point.

Current Job and Work Methods

The current method requires the workers to locate individual shipments by thumbing through paper records manually to locate the delivery information. The worker sits at a standard metal office desk surrounded by cabinets containing the shipment records. These cabinets are generally six feet wide and eight feet tall. The top of the desk would commonly contain a telephone, computer, monitor, adding machine, and writing instruments. This job was scheduled to be combined with other functions as technology advances allowed the tracing of these shipments to be completed with a computer rather than manually.

Methodology

A cross-functional team consisting of ergonomics, health and safety, industrial engineering, plant engineering, and the involved workers was formed. The first part of the plan was to determine the exact job requirements of each worker. These included written job procedures of current and future jobs as they continue to evolve into the future.

The next step was to gather information on the frequency and importance of each item located on the desk. These were placed in order of times used and the importance of being located within a functional reach. The workspace needed for each function was analyzed as well as close and remote storage capabilities. A benchmark of all activities was established and a monthly monitor system was established to track the progress of the group (Congleton, 1993).

A survey of body part discomfort was distributed to all employees. This survey along with written comments allowed all of the employees to rate their level of discomfort and to explain why they thought this level of discomfort existed. These surveys were collected and summarized by function to allow the team to concentrate on the body parts of concern.

All of the information above was used to help develop an ergonomic level of risk of discomfort. The three levels chosen were light, medium, and heavy.

This information was needed to help design new workstations and ergonomic accessories. Each work group was classified into a level of risk of discomfort, and a workstation was developed for that work group.

Training documents from the MTM Association for Research and Standards (1985) was used to develop the following variables (MTM, 1985):

Frequency of use of computer

- Infrequent Less than ½ hour per day
- Frequent ½ hour to 4 hours per day
- Constant Greater than 4 hours per day

Mode of use of computer

- Entry Continuous input of information; little analysis of display information
- Inquiry Analysis of displayed information; entries to access files through menus
- Combination Time is almost equally divided between entry and inquiry modes

Assessment

A final assessment was needed to determine how often an employee was required by his job to leave his chair. (Kroemer et al., 1994) This was categorized into less than once an hour, once an hour, and more than once an hour. All of these elements were combined to determine the ergonomic risk of discomfort.

Ergonomic Risk of Discomfort

Light	Medium	Heavy
Infrequent Use of Computer	Frequent Use of Computer	Constant Use of Computer
Inquiry Mode of Use of Computer	Inquiry Mode of Use of Computer	Entry or Combination Mode of Use of Computer
Leave Seat More Than Once an Hour	Leave Seat about Once an Hour	Leave Seat Less Than Once an Hour

The furniture levels were determined for each level of ergonomic risk:

Light	Medium	Heavy
Adjustable chair with armrests (if in seat greater than 2 hours)	Adjustable chair with armrests	Adjustable chair with armrests
Work surface at a comfortable height for paperwork	Rear work surface for computer monitor	Rear work surface for computer monitor (with a range to accommodate sitting and standing postures for 5th% female to standing 95th% male (Eastman Kodak, 1983)
Modular panel walls (height dependent on communication needs)	Maintenance adjustable	Independently adjustable front surface for keyboard
	Modular panel walls (height dependent on communication needs)	Modular Panel Walls (height dependent on communication needs)
	Other accessories: footrest, wrist rest, glare screen	Wrist rest Other accessories: footrest, glare screen
	Document holder, headset (as needed)	Document holder, headset (as needed)

The workstation developed was a counterbalance mechanism that allows the worker to adjust the station with fingertip control. This will give the worker total control on the decision to sit or stand as changes in the job occur (Kroemer, 1983). The height of the back work surface and the front work surface are independently adjustable. They may be raised or lowered individually or in tandem to comfortably fit the sitting or standing posture of the worker. The modular walls were designed to reduce the noise level and create a sense of privacy. The height of the panel (42") allowed most workers to see above the panels when standing to refocus their eyes. This reduced the feeling of confinement that a taller panel produced. The lighting was designed for an office interior and supplemented with task lighting where needed for paperwork (Sanders and McCormick, 1987).

Training

A training program was developed to help train the workforce on all of the new ergonomic features. This program taught the basic principles of human factors and ergonomics and stressed how comfort could be attained through good work methods, micro stretches, and posture. A safe work methods evaluation was then developed to help the supervisors follow up on this training. The safe work methods evaluation stressed the need to use proper methods and to utilize the new workstations, chairs, and accessories properly.

Surveys

A survey was conducted to determine how much time employees spent standing at their workstation. The survey included full time as well as part-time employees. The average amount of time spent standing was 23% and they adjusted their workstations to a standing position an average of 3.6 times per day. According to the survey, almost every employee (91%) adjusted his workstation sometime during his workday (Nerhood and Thompson, 1994). To determine the effectiveness of the new workstations and

ergonomic accessories, the following items were tracked prior to, during, and following the introduction and training of the new equipment:

- Body part discomfort surveys
- Injury/illness rates
- Productivity
- Absenteeism

The last results were taken one year following the introduction of the new equipment. Body part discomfort ratings improved by 26% following the office improvements. The number of work-related injuries or illnesses decreased by 28%, and lost time injuries decreased by 82%. The cost associated with these occurrences decreased by 95%. The productivity increase was conservatively estimated at 17% when compared to a similar site that had not received the new equipment. Absenteeism and tardiness did not change significantly. A follow-up review of the use of the new furniture in three locations showed that the lost time injury frequency was 69% less than at similar sites that did not receive the new equipment. The nonlost time injury frequency was 89% less in these sites versus similar sites that did not receive the new furniture.

Commitments

Based on the results of these ergonomic interventions, resources have been committed to provide the following:

- Adjustable chairs for employees seated for longer than 2 hours
- Adjustable workstations that allow employees to sit or stand while working and provide keyboard adjustments
- Training videos for chairs and adjustable workstations
- Office accessories catalog including choices for many items including chair, footrest, headset, monitor arm, task light, lumbar pillow, adjustable keyboard surface, etc.
- Classroom training in ergonomics for management and non-management employees
- Safety training program for the entire company including tips for office work area set-up and micro stretches

32.3 Workplace Statistics and Job Requirements

Workplace statistics and job requirements sometimes trigger review of a particular job. The trailer unload job is an example. The following factors led to review of this particular job:

1. Unacceptable injury frequency
2. High percentage of new employees starting in this job
3. Difficult to automate
4. Need for high production rates
5. Wide range of motions required

Overview

A cross-functional team comprised of health and safety, industrial engineering, operations, plant engineering, and our outside insurance carrier was formed. This team was tasked with reviewing the unload job and determining short-term and long-term changes to improve this working environment.

Over a period of six months, this team visited several different locations in various geographical regions. Prior to their arrival in a location, the management team would address all the work groups and explain that the team was coming. They would inform the workers that the team was specifically interested in their opinions of how the workplace could be improved.

Surveys

Several types of surveys and interviews were collected. All surveys were completed with a team member available to clarify any questions and collected immediately after completion. All of the surveys and interviews were completed with total confidentiality for the respondent. The first two surveys were for the part-time and full-time management. These surveys asked safety questions pertaining to:

- Training
- Performance
- Methods
- Job set-up

All available management people were interviewed.

The hourly employee surveys were divided into seniority and new employee surveys. These surveys included safety questions pertaining to:

- Methods
- Training
- Support
- Job set-up

The surveys also addressed the occurrences of injuries.

The health and safety groups for each work area participated in a focus group meeting to discuss their ideas. This was generally comprised of both management and hourly employees.

The use of videotape proved to be advantageous in this project. Two types of videotaping were utilized. The first was to fix several multiplex video cameras in place and film an unload area over several days. These tapes were then analyzed for any trends that developed over time. These tapes were also utilized for any unsafe working conditions or unsafe work practices. The second method was to utilize handheld video cameras to film specific actions and flow rates. Several buildings were selected from various parts of the country. All of the injury reports from their unload operations were analyzed. A statistical analysis of various "contributing factors" was developed. The final tool employed was an ergonomic model that calculated the kilocalorie burned for each portion of the unload job. All of the data were analyzed for trends, and solutions were sought for all of the areas that impacted the injury frequency.

Potential Solutions

A list of potential solutions was developed for each function. This list included development of new equipment, equipment modification, new method development, and new training programs. A significant contribution of this team was the development and deployment of a variable height extendor. This device extends into the trailer to carry the packages out of the trailer to the sorter. The variable height extendor adjusts from the floor to over the person's head and from side to side. A new unload stand was also developed to utilize with the variable height extendor. This new stand has a larger standing surface area and was more stable than the old unload stand. This helps the unloader to always handle packages in the power zone. The power zone is from the person's knuckle height to shoulder height. The following is a short description of the old equipment and method versus the new equipment and method.

Old Equipment and Method

- Equipment
 - Fixed height rollers
 - Conveyor with minimum mobility
 - Load stand

- Method
 - Overhead reaching
 - Low lifting
 - Twisting
 - Carrying

New Equipment and Method

- Equipment
 - Adjustable height, extending conveyor with side to side adjustment
 - New unload stand
- Method
 - Transferring — less bending
 - Leveraging
 - Pivoting

Results

This new extendor reduced the kilocalorie requirements and significantly reduced the twisting, turning, and bending requirements. The new extendor allowed greater quality, improved productivity, and required less effort.

The success of both of these projects was due to the involvement of the workers and the utilization of the cross-functional teams. Ergonomics is designing the workplace to fit the worker. It is most appropriate to involve workers in what fits best in their workplace. The cross-functional teams provide the expertise to make the necessary equipment changes, and provide the training and methods needed.

References

- Congleton, J.J. (1993). *Awareness of Ergonomics in the Workplace*. College Station, TX.
- Eastman Kodak Company. (Vol. 1, 1983; Vol. 2, 1986). *Ergonomic Design for People at Work*. New York: Van Nostrand Reinhold.
- Kroemer, K.H.E., Kroemer, H.B., and Kroemer-Elbert, K.E. (1994). *Ergonomics: How to Design for Ease and Efficiency*. Englewood Cliffs, NJ: Prentice Hall.
- Kroemer, K.H.E. (1983, March). Fitting the workplace to the human and not vice versa. *Industrial Engineering*, 55-61.
- Nerhood, H.L. and Thompson, S.W. (1994). Adjustable sit-stand workstations in the office. *Proceedings of the Human Factors Society 38th Annual Meeting*. 668-672.
- Sanders, M.S. and McCormick, E.J. (1987). *Human Factors in Engineering Design*. New York; McGraw Hill.
- The MTM Association for Standards and Research. (1985). *Ergonomics and Human Factors Training Student Training Manual*. Fairlawn, NJ.

Ergonomics in the Construction Industry

33.1	Introduction — The Size and Scope of the Problem	33-1
33.2	Using Surveillance Data to Identify High-Risk Trades	33-1
33.3	The Risk Factors Associated with Different Trades.....	33-2
33.4	Exposure Assessment for Ergonomic Risk Factors in Construction	33-2
33.5	Types of Interventions in Construction.....	33-4
33.6	Introduction and Implementation of Interventions in Construction	33-7
33.7	Regulatory Standards.....	33-7
33.8	Conclusion.....	33-8

Scott P. Schneider*

The Center to Protect Workers' Rights

33.1 Introduction — The Size and Scope of the Problem¹

There is substantial evidence that musculoskeletal injuries are a major problem in the construction industry (Schneider, 1997a). The lost-time injury rate for “sprain and strain” injuries in construction is about 50% higher than that in manufacturing and second only to the rate for the transportation industry. In 1995, the construction rate was 158.7 lost workday cases per 10,000 full-time workers, or about 1.6 cases per 100 workers (BLS, 1997). The rate in private industry overall was 107.5 cases per 10,000 workers. While this rate dropped in 1995 by almost 12% from 1994, the rate is still very high and much higher than in other industries. The rates for cumulative trauma disorders, like carpal tunnel syndrome and tendonitis, on the other hand, tend to be much lower in construction than in manufacturing industries, most likely due to increased awareness in manufacturing and, perhaps, to the less repetitive nature of construction work, in general. In 1995, the rate of lost workday injuries for carpal tunnel was only 2.8 cases per 10,000 full-time workers, compared with 8.0 in manufacturing and 3.9 in all private industry. The 1995 rate for tendonitis was 2.1 for all construction, 5.5 for manufacturing, and 2.7 for all private industry.

33.2 Using Surveillance Data to Identify High-Risk Trades

While construction work, in general, is risky for musculoskeletal injuries, the industry is diverse and the risks vary depending on the trade and the type of work done by that trade. BLS Annual Survey data show the roofing, siding, and sheet metal industry to have the highest risk of sprains and strain lost workday injuries (234.2 per 10,000 in 1995), followed by masonry contractors (202.4) and plumbing and heating

¹ Currently with the Laborers’ Health and Safety Fund of North America

(190.8). Painting and electrical contractors had the lowest lost workday injury rates in construction for sprains and strains in 1995 (128.0 and 125.2, respectively). Rates for carpal tunnel syndrome and tendonitis also varied dramatically, with carpenters having the highest rate of carpal tunnel lost workday injuries (12.1 per 10,000) and masonry contractors having the highest rate for tendonitis (7.8 per 10,000).

Hsiao and Stanevich (1996) analyzed workers' compensation data from 21 states in 1987 (the BLS Supplementary Data System) to rank construction occupations in terms of injury risks to set priorities for future research and interventions. They identified construction laborers, carpenters, roofers, and drywall installers as the four highest risk construction occupations. Overexertion injuries were the most common injury type for construction laborers, drywall installers, plumbers, electricians, and structural metal workers, (representing about 22 to 29% of injuries) and the second most common injury for roofers and carpenters.

Analyses of workers' compensation data from Washington state also show construction occupations to be risky in terms of musculoskeletal disorders (WA DL&I, 1996), showing wallboard installation, roofing and concrete construction to be three of the top 10 occupations in terms of incidence rates (first, third, and tenth, respectively).

Surveys of musculoskeletal symptoms among construction workers also show different prevalence patterns among different construction trades (Cook et al., 1996a; Engholm et al., 1997; Holmström et al., 1995, Rosecrance et al., 1977; Zimmermann et al., 1997a). Knee injuries are highest among plumbers, roofers, floorlayers, and sheet metal workers whose jobs require a lot of kneeling. Shoulder problems are most common among scaffold erectors, insulators, and painters who have to work overhead a great deal. Low-back problems are common among most trades, but highest among roofers, floor layers, and scaffold erectors who have to do a lot of heavy-materials handling and stooping. Bricklayers have high rates of elbow and shoulder symptoms apparently because of the awkward postures during work (Cook et al., 1996b). Operating engineers, who operate heavy equipment, had the lowest rates of musculoskeletal symptoms because of the nature of their work, primarily sedentary (Zimmermann et al., 1997b). These trade-specific profiles should be helpful in identifying high-priority trades and areas for intervention.

33.3 The Risk Factors Associated with Different Trades

Certain construction trades have been extensively studied while others have not. Some trades are easier to study in that they perform a more limited number of tasks, like bricklayers and concrete reinforcement workers. Other trades, like carpenters and construction laborers, perform a wide variety of work and only certain subtrades, like drywall installers, have been well studied. Table 33.1 summarizes the state of research on ergonomic problems in the construction trades (CPWR, 1996).

For most trades, there is substantial information of the types of musculoskeletal injuries occurring in that trade. For many of the trades there has been a delineation of the tasks they perform, and high-risk tasks have been identified. Interventions have been identified for some trades, but few have been evaluated. The largest problem remaining for research is identifying the barriers to adoption of these interventions and how these barriers could be overcome.

Trades that have been thoroughly studied include: concrete reinforcement workers (rodmen) (Saari et al., 1978; Wakula et al., 1997), bricklayers (Cook et al., 1996b; Schierhorn, 1996), carpet layers (Thun et al., 1987; Tanaka et al., 1989), and operating engineers (Zimmermann, 1997b).

33.4 Exposure Assessment for Ergonomic Risk Factors in Construction

Most ergonomic exposure assessment for exposure to risk factors has taken place in industries where workers have relatively short cycle jobs, like assembly line work. Recently though there has been a growing interest in looking at long cycle jobs, like those in construction. The approach has generally been to look at the risk factors for individual tasks and either sum up the stresses based on estimates of time spent in the task or use the information to prioritize tasks for intervention. Systems that have been adapted or

TABLE 33.1 Status of Research on Ergonomic Problems in Construction by Trade

Trade	WMD	Tasks	Hi Risk	Intervention	Barriers
Bricklayers	√	√	√	√	*
Carpenters					
drywall	√	√	√	√/*	*
concrete form	√	√	√	*	*
frame	√	*	*	*	*
finish	√	*	*	*	*
pile driver	*	*	*	*	*
ceiling	√	√	√	*	*
tile, terrazzo	*	*	*	*	*
lather	*	*	*	*	*
cabinetmaker	*	*	*	*	*
scaffolder	√	√	√	*/√	*
carpet/floorlayer	√	√	√	*/√	*
diver	*	*	*	*	*
exhibit	*	*	*	*	*
millwright	*	*	*	*	*
maintenance	√	*	*	*	*
Cement Masons	√	√	*	*	*
Electricians	√	*	*	*	*
Elevator Constructors	*	*	*	*	*
Insulators	*	*	*	*	*
Ironworkers					
structural	√	√	*	*	*
rodmen	√	√	√	*/√	*
ornamental	*	*	*	*	*
shop	*	*	*	*	*
Laborers	√	*	*	*	*
Operating Engineers					
operators	√	√	√	√	*
stationary	*	*	*	*	*
Painters	√	*	*	*	*
carpet/floorlayer	√	√	√	*	*
glaziers	*	*	*	*	*
Plasterers	√	√	*	*	*
Plumbers	√	√	*	*	*
Pipefitters	√	√	*	*	*
Roofers					
residential	√	*/√	*/√	*	*
commercial	√	*/√	*/√	*	*
Sprinklerfitters	*	*/√	*/√	*	*
Sheet Metal					
shop	*	√	*	*	*
field	√	√	*	*	*
Teamsters	*	*	*	*	*

* = needs more research

√ = unknown

created for ergonomic exposure assessment in construction include the OWAS method (Kivi and Mattila, 1991; Mattila et al., 1993), ARBAN method (Wagenheim et al., 1986), PATH method (Buchholz et al., 1996), and MAS method (Schildge et al., 1997; Wakula et al., 1997). These methods tend to estimate the percentage of time spent in awkward postures during given tasks. Time spent in a task is estimated by diaries, self reports, or expert observers. Studies are now under way to validate these methods against more quantitative methods, like dosimeters. Checklists for exposure assessment in construction are also being studied (Everett, 1997; Buchholz et al., 1996). Exposure assessment in construction is still at an early stage. Its importance will grow, particularly as a tool to measure the efficacy of interventions.

33.5 Types of Interventions in Construction

Ergonomics has often been associated with manufacturing and office work environments. Consequently, consideration of ergonomics in construction appears disconcerting. Contractors and workers seem to believe that construction work is hard manual labor and there is nothing that can be done to change it. This is despite the evidence of how the work has actually changed over the past 10 to 15 years. Construction work, while it has not become automated like assembly-line work, has become more mechanized. More and different kinds of equipment are now used on job sites to move materials and to do some of the heavy work. Hoists and cranes are commonly used for materials handling. Boom trucks are used to lift materials to roof level. Scissors lifts are commonly used to move workers up to work at heights. Motorized buggies are used to move materials around on sites. Powered equipment like roof cutters, powered brooms and gravel removal equipment, and powered roof tear-off equipment all have reduced the risk of strains and sprains in roofing tear-off work. Asphalt is now pumped to the roof rather than being mixed in small batches in a kettle. Circular saws, powered screw guns (battery-operated), and pneumatic nail guns have made carpenters' work easier. Robots even exist now for doing demolition work. Yet even with this new equipment there is still a high risk of injury and a significant amount of manual work and work in awkward postures. In some cases, the contractors are too small to afford or use such equipment. In other cases, the demands of a particular job may not allow their use. In addition, many jobs cannot be mechanized.

Ergonomic interventions in construction do not all revolve around mechanization or automation. In fact, most "ergonomic" changes in construction involve little more than proper planning of the job.

Interventions to reduce the risk of musculoskeletal disorders in construction can be classified as follows: (A) new materials, (B) new tools and equipment, (C) improved work practices, (D) improved work organization and planning, (E) education and exercise, and (F) personal protective equipment.

A) New materials. Construction materials have changed over the past few decades. Drywall has essentially replaced plaster walls. Poured concrete has replaced a lot of brick walls. Many sections of houses now come prefabricated. Sometimes the changes are beneficial from an ergonomic point of view. Other times they trade one hazard for another. Drywall work, as mentioned earlier, is one of the most hazardous trades in construction for musculoskeletal injuries. The trend in newer materials can be useful when lighter-weight materials are designed. For example, the Army Corps of Engineers worked with the University of Nebraska to design a new masonry block, the Nebraska A block, which is half the weight of a traditional block but just as strong (Hooker, 1996). Another solution instituted in Germany was the design of a new masonry block that has hand holds to make it easier to handle (Kaiser and Linke-Kaiser, 1992). The weight and the diameter (normally 4 ft) of drywall make its use hazardous. In Sweden, the industry has been promoting the use of 3 ft wide (90 cm) drywall boards, which are easier to install than the larger size, but consequently increase the amount of drywall taping and screwing required. (Isakson et al., 1992; Björklund et al., 1991). The use of fiberglass ladders reduces the weight of handling compared with wood ladders. Plastic pipe has also reduced the weight of materials for plumbers.

B) New tools and equipment are constantly being invented to make construction work easier. Tool catalogues from tool suppliers and trade publications are a good source for keeping up with such tools. These tools are designed to reduce the need for bending, e.g., allow for work from a standing height, like guns for fastening roofing insulation and automatic feeding screwguns for fastening flooring. Hand tools can reduce the stress on the hand by having softer, easier-to-hold surfaces. Handles are available to make carrying materials easier. Carts and dollies can be used to help move materials around a site and reduce the need for manual handling. Pulleys and hoists make it easier to lift materials. Stands, like pipe stands, can be used to bring work to waist height. Sit-stand stools or matting can reduce the risk of back injury from standing on concrete all day (Redfern, 1995). Racks can be used for storing materials at waist height.

Power tools can be purchased with vibration dampening to reduce the amount of vibration transmitted to the hands. Construction vehicles now have better-designed cabs available which are more comfortable and reduce the transmission of whole-body vibration through the seat. Many of the best tools have been designed or invented by tradespeople who felt they needed something new to do the job right or easier

(Wigmore and Moir, 1997). The proper design of tools requires usability testing with tradespeople to understand the way tools are used in the field and the demands placed on them by workers (Bobjer and Jansson, 1997). The design of any new tool or equipment should include an evaluation to demonstrate reduced risk of injury or, at least, a reduction in risk-factor exposure.

C) Improved work practices involve changing how the work is done. By substituting a scissors lift for a ladder, workers can get to overhead work more easily and position themselves closer to the work, requiring less work with arms above shoulder level. Getting two workers to carry drywall (e.g., using drywall handles on the front and back) or relying on carts and dollies can reduce the risk of injury from materials handling. For those tasks where manual handling is unavoidable, teaching better work technique is important. For example, lifting heavy bags from ground level should be done from a kneeling position by sliding the bag onto the knee and then standing. Drywall boards should first be tipped on end before being picked up (CSAO, 1991). Studies have shown that work techniques of older, experienced workers may be more efficient than and ergonomically preferable to those of apprentices or novices (Authier et al., 1996). Training in these techniques could help reduce the risk of musculoskeletal injuries although it is unclear at this point how effective such training is.

D) Improved work organization means changing the way the work is organized to reduce the risk of injury. The foreman and superintendent on a job have a major role to play in the proper planning of the job to make sure it gets done on time and gets done safely. Through proper planning these two goals can complement each other. They need to make sure that materials are delivered on time and as close to the work area where they will be used as possible. They also want to avoid ordering or delivering too much material at once which leads to problems with storage and a cluttered worksite. They need to make sure work is done by the various subcontractors on time in order to not delay the subsequent contractors and place them under heavy production pressures to catch up. A Swedish project called "Building for the 21st Century" has called for bringing workers into the production planning process as the best method to improve planning and reduce production pressures (Kortabygtider).

Sufficient helpers, apprentices, or materials handlers should be available to make sure workers are supplied with the materials and equipment they need when they need it. They need to ensure the availability and usability of materials-handling devices (carts, dollies, hoists, cranes). Crane time can sometimes be at a premium and proper scheduling of crane time can significantly reduce manual materials handling. A proper break schedule is also critical. Insufficient rest breaks lead to fatigue and reduce productivity as well as increasing risk of injury. In addition to scheduled rest breaks, short mini-breaks (e.g., 30 second "micropauses") have been shown to reduce fatigue and increase productivity in drywall installers (Anderson, 1991). Piece rate work has been shown to be a risk factor for musculoskeletal injuries (Brisson et al., 1989). In construction, drywall installation is one of the few jobs which is commonly paid on a piece rate. This may be one reason it has one of the highest risks for injury. The distribution of workload is another important work organization issue that needs to be addressed.

Improved housekeeping has also been shown to be related to reduced risk of injury (Oxenburgh, 1991). This is an important work organization issue, because it requires the cooperation and coordination of all subcontractors on the site. Superintendents must make clear that each subcontractor is responsible for its own housekeeping to avoid creating a hazard for others. Sometimes they take on more responsibility and develop joint clean-up crews to organize housekeeping on a site-wide basis.

Job rotation, e.g., rotating workers between physically demanding and less physically demanding jobs, can sometimes be done in construction. In addition, teaming of workers who can often rotate tasks is possible. Another concern is that often young workers carry a disproportionate amount of the heavy work on a site. This increases their risk of injury, particularly the chronic injuries that will accumulate later in life. While the heavy work cannot be redistributed to the older or less physically capable workers, they need to be sensitive to not straining or pushing the younger workers too hard. By reducing the workload for all workers, the work can be distributed more evenly and more fairly.

Architects and engineers also have a major role to play upstream, while the project is being designed. By specifying lighter-weight materials, e.g., 3-foot-wide drywall, they can reduce the load on the construction workers. In Sweden, designers placed pipes on the wall of a utility tunnel instead of overhead,

reducing the amount of overhead work (Björk, 1984). The more ergonomics can be considered in the design of buildings, the less we have to rely on *post hoc* changes as the building is being built. Superintendents and foremen also need to structure the job so that issues of ergonomics can be incorporated into their regular safety program and walk arounds. A construction ergonomics checklist has been designed specifically to get safety personnel thinking about ergonomic issues on their worksite (CPWR, 1997).

E) Education and exercise have also been suggested as effective interventions for ergonomic risk factors in construction. Ergonomics training is becoming more common in the construction trades. The Carpenters Union has developed a half-day training program on ergonomics for carpenters which is given through their apprenticeship schools (UBC Safety & Health Fund, 1996). The Building Trades Department of the AFL-CIO is developing a training module on ergonomics to be given to all apprentices as part of their safety training. Contractors who do ergonomics training tend to focus on proper lifting technique and stretching exercises, while these new training programs focus on identification of risk factors and problem solving to identify potential solutions. They also tend to include more participatory training techniques, where workers are active participants in the learning process, which appear to be more effective and allow workers to share their knowledge of conditions and experiences in crafting solutions (Shurman et al., 1994).

Labeling of the weights of materials to be manually handled may also help reduce the risk of musculoskeletal injuries (Butler et al., 1993). It has been suggested that construction materials be labeled where possible with the weight and color coded labels to indicate if it was safe to lift manually or alone (Schneider, 1994a).

Exercise or stretching programs have become popular among construction contractors over the past few years. They operate on the assumption that by stretching the muscles and tendons prior to work, they can better adjust or acclimate to the stresses placed on them later in the day. There have been two evaluations done on stretching programs in the construction industry, one in Sweden and one in the U.S. (Cederqvist 1994; Hecker and Gibbons, 1997). Both were surveys of workers involved in a pre-job stretching program. Both found positive results. Workers who did the stretching exercises liked them and felt that they helped in reducing fatigue and increasing awareness of ergonomic risk factors. In general they felt better at the end of the day. A large percentage also continued doing the exercises on weekends and said they would continue doing them on their next job. While this does not necessarily translate into lower injury rates, these positive indicators are some support for continuing these programs and further evaluation of their impact.

F) Personal protective equipment (PPE) is normally the last resort in terms of intervention strategies. It allows the continued presence of a risk factor and the worker must rely on the proper use of a device to intervene and modify the effect of the exposure. This is a less reliable strategy. Yet in construction, there are several instances where PPE can be necessary. While some work can be modified to allow work to be done from a standing height, there will still be some work required at floor level. Kneeling will have to be done at some point. Large amounts of time spent kneeling has been correlated with knee disorders. So clearly knee pads can play an important role in prevention of knee disorders in construction. The problem is that workers do not like to wear knee pads. The straps used to keep them on bind against the back of the legs and make them uncomfortable to wear. One possible solution is pants with knee pad pockets in front of the legs. Shoulder pads are also available for construction workers who have to carry materials on their shoulder, where contact stresses can pinch nerves and tendons and contribute to shoulder disorders. There are also shoe insole pads designed to reduce stress on the back for those workers who have to walk around all day on concrete.

The most controversial protective equipment issue in ergonomics for construction workers is the use of back belts. During the 1990s they have become increasingly popular among contractors. Yet there is little evidence to support their use in preventing back injuries in the first instance (NIOSH, Back Belt Working Group, 1994), although a recent study indicated they may have some efficacy (Kraus et al., 1996). If they are used, use should be voluntary and should be accompanied by an education and training program on proper use. They should also be used under the supervision of a physician who can certify that workers are fit to wear them. It should be emphasized that use of the belt does not allow a worker

to lift more than he normally would. They should only be considered a supplement to a complete ergonomics program and not a substitute for one. There should also be a program of quality assurance to make sure people are using the belts properly.

33.6 Introduction and Implementation of Interventions in Construction

While there are many potential ergonomic interventions in construction, few have been adopted. Making ergonomic changes in construction is difficult, but there are many possible interventions (Schneider, 1995; Schneider et al., 1995). The construction industry is inherently conservative. Workers tend to be individualistic and safety culture is difficult to change. This is in part due to the nature of the work, where workers are changing jobs frequently and may also change employers. Ergonomic challenges also change as the job site changes. There are four different levels of ergonomic changes available in construction: industry-wide changes, company-wide changes, site-specific changes, and changes on the individual level (Schneider, 1996b). Industry-wide changes include: development of new ergonomically designed tools, changes in materials used (e.g., switching to 3-ft-wide (90 cm) drywall), and availability of new equipment (e.g., adjustable height scaffolding). These changes are the most difficult to accomplish, because of the investment required for the development of new tools and equipment and the level of proof required before contractors will adopt new methods. Company-wide changes depend primarily on individuals in authority within those companies who have the vision or commitment to safety and are willing to try out changes. Site-specific changes depend on the job superintendent, if he or she is willing to try out new methods and chance their potential impact on the production schedule. Sometimes change on an individual site depends as well on the owners of the project. If they are open to new methods and willing to pay for interventions (which hopefully will result in some payback in less lost work time and injuries), then superintendents are willing to go along with such programs. Changes on the individual level are the most difficult to sustain in that each individual's behavior must be changed and monitored. Workers who have been doing a job one way for many years are often reluctant to change. Such changes are most effective when introduced early in their careers when they are learning as apprentices. But teaching a person how to lift heavy materials properly does not solve the problem the way a foreman or superintendent can, by ensuring carts or dollies are available and in good working order or by ensuring that materials are delivered as close as possible to where they will be used. Also the fundamental problems posed by poor planning can only be solved by superintendents, working in conjunction with the workers, on a site-wide level. Changes on the site-wide or company-wide level have much more potential for reducing the risk of injury than individual changes.

There are numerous problems in making changes in construction. If changes are primarily motivated by the need to save money and the promise of increased productivity, workers may be resistant to changes, since higher productivity means doing more work with fewer workers. This is also true if changes, in making the jobs easier, also deskill the work. Lower skill required often means less pay for workers, which means workers can be expected to resist these changes as well. Recently, several participatory ergonomic projects have been tried in construction with great success (Bronkhorst et al., 1997; van der Molen et al., 1997b; Moir, et al., 1996). Workers have been included in the process of identification of high-risk tasks and potential solutions. Projects have led to the development of successful interventions for scaffold erectors, glaziers, and other trades. By including workers in each phase of the process, acceptance of interventions and changes is much easier.

33.7 Regulatory Standards

Another way to effect change in an entire industry is through regulation. For the past several years, the federal government has been working on the development of an OSHA standard for the prevention of

musculoskeletal injuries. A draft of this proposed standard was circulated in March 1995. The OSHA Advisory Committee for Construction Safety and Health (ACCSH) set up a work group which reviewed the draft and proposed changes to make it more useful in construction (Schneider, 1996a).

In 1997, California OSHA promulgated a standard for the prevention of cumulative trauma disorders. While this standard would have exempted much of the construction industry, because it exempted employers with nine or fewer employees, the California Supreme Court struck down that provision in September 1997.

In the meantime, the U.S. Army Corps of Engineers, one of the largest construction employers in the U.S., issued a “cumulative trauma prevention” standard in September 1996 which applies to all contractors doing work for the Corps (Schneider, 1997b). It is a programmatic standard requiring job hazard analyses before each job to identify potential ergonomic risk factors and potential solutions to be instituted. Workers must get ergonomic training. Contractors must also reduce vibration exposures to below the ACGIH TLV.

The ASC Z 365 committee is finalizing its draft standard for the prevention of cumulative trauma disorders of the upper extremity, which would also apply in the construction industry. It was approved in Spring 1998. While this is a voluntary standard, these standards do set some minimum expectations with regard to safety programs which often become industry-wide standard practice. This draft standard is also a programmatic one which requires employers to identify high-risk jobs or tasks, develop potential solutions, implement and evaluate those solutions, and develop a medical management program for injured workers to help them return to work (Armstrong, 1997).

Other countries have developed or implemented standards to prevent musculoskeletal injuries in construction. Germany and Sweden have issue rules limiting the weight of masonry blocks that can be lifted manually (Swedish Standards, Kuger et al., 1992). (Masonry union contracts in the U.S. also contain weight limits for blocks that can be lifted by one person.) In The Netherlands, the Stichting Arbouw (a joint labor–management group) has developed “Guidelines for Physical Workload in the Construction Industry” which contain limits on lifting, carrying, pushing and pulling, static postures, and repetitive work. The guidelines prescribe red (interventions required), yellow (interventions should be planned), and green (permissible) levels of effort (Stichting Arbouw, 1997, van der Molen, 1997a).

33.8 Conclusion

Musculoskeletal injuries are a major problem in the construction industry. They constitute a large percentage of the lost workday injuries and workers’ compensation cases and costs. They also result in shortened careers for many construction workers. Ergonomics is the process by which these injuries can be addressed and many of them prevented. High-risk trades can be identified through injury and symptom surveillance and associated with specific types of injuries. High-risk tasks can be identified through observations and focus groups of workers and through quantitative measurements of exposures to well-known risk factors, like awkward postures. A wide range of interventions are available, although few have been tested for efficacy. Interventions include: materials handling equipment, improved tools, new work methods, better work organization and planning, worker training, exercise programs, and personal protective equipment. The most effective strategies are those which effect change in the design of the work and those which include workers in each and every step of the process (a participatory ergonomics program). There are several recent examples of such successful projects in the construction industry. But change in the construction industry is difficult. There has to be an acknowledgment of the problem and a willingness to try new ideas and techniques, even though they may not prove effective. But those firms which are committed to attacking this problem properly will find a great potential for success.

Acknowledgments

This research was funded through a cooperative agreement (# CCU/02-312014) from the National Institute for Occupational Safety and Health (NIOSH) to the Center to Protect Workers' Rights (CPWR), the research arm of the Building and Construction Trades Department of the AFL-CIO.

References

- Anderson, P: Manual screw tightening with and without micro pauses, *Bygghälsan Bulletine*, 91-09-16, 39-40, 1991.
- Armstrong, T: Development of a voluntary standard for the control of work-related cumulative trauma disorders in the United States: ANSI Z365, *Proceedings of the 13th Triennial Congress of the International Ergonomics Association*, June 29–July 4, Tampere, Finland, 3: 483-485, 1997.
- Authier, M; Lortie, M; Gagnon, M: Manual handling techniques: comparing novices and experts, *International Journal of Industrial Ergonomics*, 17: 419-429, 1996.
- Björk, L: Survey of working environment in the plumbing sector, *Bygghälsan Bulletine*, 1984-09-01, pgs. 4-5, 1984.
- Björklund, M; Helmerskog, P; Nordberg/Bohlin, M; et al.: 90-sheets for the 90s, *Bygghälsan Bulletine* 91-09-16, pgs. 35-36, 1991.
- Bobjer, O; Jansson, C: A research approach to the design of ergonomic hand tools. The 11-point approach, *Proceedings of 13th Triennial Congress of the International Ergonomics Association*, June 29–July 4, Tampere, Finland, 2: 193-195, 1997.
- Brisson, C; Vinet, A; Vézina, M; Gingras, S: Effect of duration of employment in piecework on severe disability among female garment workers. *Scandinavian Journal of Work, Environment and Health*, 15:329-334, 1989.
- Bronkhorst, RE; Vink, P; Koningsveld, EAP: Ergonomic improvements for the glazier — new working methods and tools do improve the working conditions, *Presentation to the 13th Triennial Congress of the International Ergonomics Association*, June 29–July 4, Tampere, Finland, 1997.
- Buchholz, B; Paquet, V; Punnett, L; Lee, D; Moir, S: PATH: A work sampling-based approach to ergonomics job analysis for construction and other non-repetitive work, *Applied Ergonomics*, 27(3): 177-187, 1996.
- Bureau of Labor Statistics (BLS), Data from the 1995 Annual Survey of Occupational Injuries and Illnesses, Data obtained from BLS Website (<http://www.bls.gov>).
- Butler, D; Andersson, GBJ; Trafimow, J; Schipplein, OD; Andriacchi, TP: The influence of load knowledge on lifting technique, *Ergonomics* 36 (12): 1489-1493, 1993.
- Cederqvist, T: Prevention of musculo-skeletal injuries in the swedish construction industry— experience from five years of a pre-work warm-up program, *Proceedings of the 12th Triennial Congress of the International Ergonomics Association*, August 15-19, Toronto, Canada, 2: 60-62, 1994.
- Center to Protect Workers' Rights, (CPWR). *Construction safety and health research: five years of progress and proposals for the future* — Report of the CPWR-NIOSH Program Planning Conference *Joint Strategies to Advance Research in the Construction Industry*, Cincinnati, OH April 1–2, 1996.
- Center to Protect Workers' Rights, (CPWR). "Construction Ergonomics Checklist," 6 pages, 1997.
- Construction Safety Association of Ontario (CSAO), *Stand, Lift, Carry*, Revised, 1993 edition, 41 pages, Toronto, Ontario.
- Cook, TM; Rosecrance, JC; Zimmermann, CL: *The University of Iowa Construction Survey*, The University of Iowa and the Center to Protect Workers' Rights, Washington, D.C. April 1996a.
- Cook, TM; Rosecrance, JC; Zimmermann, CL: Work-related musculoskeletal disorders in bricklaying: a symptom and job factors survey and guidelines for improvement, *Applied Occupational and Environmental Hygiene*, 11 (11): 1335-1339, November 1996b.

- Engholm, G; Holmström, H: Physical exposures, psycho-social factors and patterns of prevalence of musculoskeletal disorders in various groups of Swedish construction workers, Presentation to the 13th Triennial Congress of the International Ergonomics Association, June 29–July 4, Tampere, Finland, 1997.
- Everett, JG: Application of U.S.A. OSHA Draft Ergonomic Protection Standard to Construction Tasks, *Proceedings of the 13th Triennial Congress of the International Ergonomics Association*, June 29–July 4, Tampere, Finland, 6: 93-95, 1997.
- Hecker, S; Gibbons, B: Evaluation of a prework stretching program in the construction industry, *Proceedings of the 13th Triennial Congress of the International Ergonomics Association*, June 29–July 4, Tampere, Finland, 6: 115-117, 1997.
- Holmström, E; Ulrich M; Engholm, E: Musculoskeletal disorders in construction workers, *Occupational Medicine: State of the Art Reviews*, 10(2), April 1995, pgs. 295-312, *Construction Safety and Health*, Eds. K. Ringen, A. Englund, L. Welch, J. Weeks and J. Seegal, Hanley & Belfus, Philadelphia, 1995.
- Hooker, KA: Specialty block for special uses, *Masonry Construction* 9(5): 198-201, May 1996.
- Hsaio, H; Stanevich, RL: Injuries and ergonomic applications in construction, Chapter 27, Pgs. 545-568 in *Occupational Ergonomics: Theory and Applications*, Eds. A. Bhattacharya and J.D. McGlothlin, Marcel Dekker, New York, 1996.
- Isakson, H; Kling, J: Fitting 900mm and 1200 mm plasterboard sheets, *Bygghälsan Bulletine*, 91-09-16, pgs. 37-38, 1991.
- Kaiser, R; and Linke-Kaiser, G: Verbesserung der Arbeitsbedingungen im Mauerwerksbau *ErgoMed*, 16: 14-25, 1992.
- Kivi, P; Mattila, M: Analysis and improvement of work postures in the building industry: application of the computerised OWAS method, *Applied Ergonomics*, 22(1): 43-48, 1991.
- Kortabyggtider, Building for the 21st Century: Results from the Development Programme Tight Construction Schedules, a publication from a joint employer-employee working group in Sweden.
- Kraus, JF; Brown, KA; McArthur, DL; Peek-Asa, C; Samaniego, L; Kraus, C: Reduction of acute low back injuries by use of back supports, *Int. J. Occup. Environ. Health*, 2: 264-273, 1996.
- Mattila, M; Karwowski, W; Vilkki, M: Analysis of working postures in hammering tasks on building construction sites using the computerized OWAS method, *Applied Ergonomics*, 24(6): 405-412, 1993.
- Moir, S; Buchholz, B: Emerging participatory approaches to ergonomic interventions in the construction industry, *Am. J. Industrial Medicine*, 29, 425-430, 1996.
- NIOSH Back Belt Working Group, *Workplace Use of Back Belts: Review and Recommendations*, National Institute for Occupational Safety and Health, Centers for Disease Control, U.S. Department of Health and Human Services, July 1994.
- Oxenburgh, M: *Increasing Productivity and Profit through Health and Safety*, CCH International, Chicago, 309 pgs., 1991.
- Redfern, MS: Influence of flooring on standing fatigue, *Human Factors*, 37(3): 570-581, 1995.
- Rosecrance, JC; Cook, TM; Zimmermann, CL: Work-related musculoskeletal symptoms among construction workers in the pipe trades, *Work*, 7: 13-20, 1996.
- Saari, J; G. Wickström: Load on back in concrete reinforcement work, *Scan. J. Work Environ. Health*, 4 suppl. 1: 13-19 (1978).
- Schierhorn, C: Jobsite ergonomics, *Masonry Construction*, 9(5): 202-207, May 1996.
- Schildge, B; Wakula, J; Rohmert, W: Ergonomic Analysis of load on the knees at the tile-setter's work, *Proceedings of the 13th Triennial Congress of the International Ergonomics Association*, June 29–July 4, Tampere, Finland, Volume 6: pgs. 163-165, 1997.
- Schneider, S: Musculoskeletal injuries in construction: are they a problem?, *Proceedings of the 13th Triennial Congress of the International Ergonomics Association*, June 29–July 4, Tampere, Finland, Volume 6: pgs. 169-171, 1997a.
- Schneider, S: The U.S. Army Corps of Engineers ergonomics standard, *Applied Occupational and Environmental Hygiene*, 12(7): 460-461, July, Ergonomics Column, 1997b.

- Schneider, S: OSHA's draft standard for the prevention of musculoskeletal disorders: the construction revision, pp. 953-955, *AIHA Journal*, 57 (10), October 1996a.
- Schneider, S: CYBERG 96 paper, September, *Making Ergonomic Changes in Construction*, 1996b.
- Schneider, S: Implement ergonomic interventions in construction, *Applied Occupational and Environmental Hygiene*, 10(11): 822-824, October, Ergonomics Column, 1995.
- Schneider S; Punnett L; and Cook T: Ergonomics: applying what we know, in *Construction Safety and Health*, in the *Occupational Medicine: State of the Art Reviews* series, Vol. 10 (2):385-394, Eds. K. Ringen, A. Englund, L. Welch, J. Weeks and J. Seegal, Hanley & Belfus, Philadelphia, 1995.
- Schneider, S: Ergonomic safety data sheets, *Applied Occupational and Environmental Hygiene*, 9(6): 402-403, June, Ergonomics Column, 1994a.
- Schneider, S; Susi, P: Ergonomics and construction: a review of potential hazards in new construction, July 1994, *American Industrial Hygiene Association Journal*, 55 (7): 635-649, 1994b.
- Shurman, S; Silverstein, BA; Richards, SE: Designing a curriculum for healthy work: reflections on the United Automobile, Aerospace and Agricultural Implement Workers — General Motors Ergonomics Pilot Project, *Occupational medicine: State of the Art Reviews*, 9(2): 283-304, 1994.
- Stichting Arbouw, *Arbouw Foundation Guidelines on Physical Workload for the Construction Industry*, Amsterdam, May 1997, 19 pgs.
- Swedish Standards for Masonry Block Work (Svenska Standard SS 22 72 30), Swedish Ministry of Labour.
- Tanaka, S; ST Lee; W.E. Halperin; M. Thun; Smith, AB: Reducing knee morbidity among carpetlayers, *Am. J. Public Health*, 79(3): 334-335, 1989.
- Thun, M; S. Tanaka, AB; Smith, WE; Halperin, ST; Lee, ME; Luggen; EV Hess: Morbidity from repetitive knee trauma in carpet and floor layers. *Br. J. Indus. Med.*, 44: 611-620, 1987.
- UBC Safety and Health Fund of North America, *Ergonomics for Carpenters*, Washington, D.C., 88 pgs., 1996.
- van der Molen, HF; Delleman, NJ; Arbouw guidelines on physical workload for the construction industry, *Proceedings of the 13th Triennial Congress of the International Ergonomics Association*, June 29–July 4, Tampere, Finland, Volume 6: pgs. 197-199, 1997a.
- van der Molen, HF; Vink, P; Urlings, IJM: A participatory ergonomic approach to the redesign of scaffolders work, *Proceedings of the 13th Triennial Congress of the International Ergonomics Association*, June 29–July 4, Tampere, Finland, Volume 1: pgs. 450-452, 1997b.
- Wagenheim, M; Samuelson, Björn; Wos, H: ARBAN-A force ergonomic analysis method, Chapter 21 in *The Ergonomics of Working Postures*, International Occupational Ergonomics Symposium, April 15-17, 1985, Zadar, Croatia (Yugoslavia), Eds. Nigel Corlett, John Wilson, and Ilija Manenica, London, Taylor and Francis, pages 241-255, 1986.
- Wakula, J; Wimmel, F; Linke-Kaiser, G; Hoffman, G; Kaiser, R: Ergonomic Analysis of load on the back in concrete work, *Proceedings of the 13th Triennial Congress of the International Ergonomics Association*, June 29–July 4, 1997, Tampere, Finland, Volume 6: pgs. 191-193, 1997.
- Washington State Department of Labor and Industries (WA DL & I), *Work-Related Musculoskeletal Disorders: Washington State Summary 1992-1994*, October, 84 pages, 1996.
- Wigmore, D; Moir, S: Bright ideas: construction worker's innovations on the job, Presentation to the American Industrial Hygiene Conference and Exposition, Dallas, TX, May 19, 1997.
- Zimmermann, CL; Cook, TM; Rosecrance, JC: Trade-specific trends in self-reported musculoskeletal symptoms and job factor perceptions among unionized construction workers, *Proceedings of the 13th Triennial Congress of the International Ergonomics Association*, June 29–July 4, Tampere, Finland, Volume 6: pgs. 214-216, 1997a.
- Zimmermann, CL; Cook, TM; Rosecrance, JC: Work-related musculoskeletal symptoms and injuries among operating engineers: a review and guidelines for improvement, *Applied Occupational and Environmental Hygiene*, 12 (7): 480-484, July 1997b.

Ergonomics Issues in Air Traffic Management

Karol Kerns

The MITRE Corporation

Philip J. Smith

The Ohio State University

C. Elaine McCoy

Ohio University

Judith Orasanu

NASA Ames Research Center

34.1	Introduction	34-1
34.2	System Overview	34-2
34.3	Human Factors in Air Traffic Control	34-4
	Missions and Tasks within the ATC System • Ergonomic Issues in ATC	
34.4	Human Factors in Traffic Flow Management.....	34-14
	Sample Control Methods within the TFM System • Traffic Flow Management — Conceptual Framework • Ergonomics in TFM	
34.5	Issues in the Design of the Future ATM System	34-18
	New Philosophies and Procedures	
34.6	Conclusion.....	34-21

34.1 Introduction

The air traffic management (ATM) system poses a broad set of human factors challenges. These range from the design of tools to support work by individual controllers, to the development of procedures and tools to support cooperative work by flight crews, controllers, traffic managers, and dispatchers, to the allocation of tasks within an overall system architecture such that the cognitive demands of the work performed by individuals are at acceptable levels while still achieving a high level of system performance (Wickens, Mavor, and McGee, 1997).

This chapter describes a system-wide view of the human factors in the current and future ATM system. The term, air traffic management, is a relatively new one that denotes both of the system's primary functions, air traffic control (ATC) and traffic flow management (TFM). This term also recognizes the ongoing changes in the organizational culture and operating philosophy of the system, with greater emphasis on service to and collaboration with system users, less on control. With this in mind, this chapter provides an overview of the main human factors topics in ATM and an explanation of the operational context in which they occur. A major focus of the chapter is on the current and future operating philosophies, processes, and technologies and their implications for human performance and human factors research and practice.

This chapter first briefly outlines the components of the system as it exists in the United States (which is the context that will be used for discussing human factors issues). Then, the air traffic control system is discussed, giving a broad survey of the current and emerging issues and an assessment of the role and status of human factors. Following that, the traffic flow management system is discussed, emphasizing the importance of the impact of the overall system architecture on the demands placed on individuals within the system. Finally, there is a discussion of the human factors implications of proposed future designs for the air traffic management system in the United States.

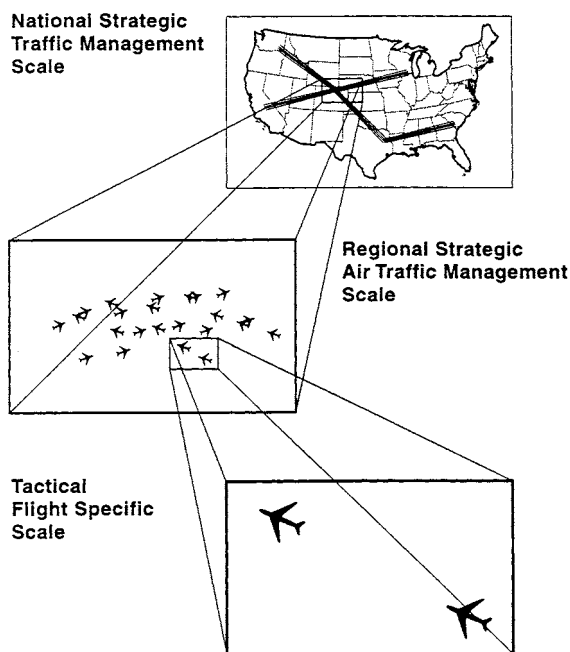

FIGURE 34.1 The hierarchical nature of air traffic management. (From Klein, G. 1992. *The Human Air Traffic Management Role in a Highly Automated Air Traffic System*. MITRE Technical Report # ARDATMR-MTR-92W0000075, McLean, VA. With permission.)

34.2 System Overview

The design of the ATM system reflects important concepts about information management and social organization. Figure 34.1 illustrates the basic hierarchical nature of this design and of the management domains that make up the air traffic environment. Information regarding air traffic can be partitioned into a hierarchy of domains based on its quality and granularity. As is shown in the figure, long-run strategic planning based on aggregate traffic demand data must be done to make decisions about resource allocations and about rules and procedures, along with daily strategic traffic flow management decisions, while tactical activities, based on flight-specific data, must be done to assure separation of individual aircraft. The goal of these strategic planning activities is to ensure that controllers, pilots, and dispatchers can safely coordinate the activities of specific aircraft in order to assure safe, effective utilization of the airspace and airport facilities (Klein, 1992).

The ATM system is also organized hierarchically to take advantage of the informational structure (see Figure 34.2). At an organizational level, the ATM system has a hierarchical structure in which the tactical and strategic air traffic management functions are allocated among various ATC and TFM organizational units. Although it is useful to discuss these functions as if they were associated with discrete organizational units, in practice, the elements of the functions are intertwined with overlapping and redundant responsibilities to ensure system reliability.

At the lowest level of organization, the ATM system is organized to assure aircraft separation throughout all phases of flight from takeoff to landing. To accomplish this, the ATC component of the system is composed of controllers and specialists working in several different types of facilities. These include:

1. Towers at airports, with air traffic controllers responsible for directing arrivals and departures
2. Terminal radar-approach control facilities (*TRACONS*), with controllers guiding flights for roughly the first and last 40 miles of flight
3. Air route traffic control centers (*ARTCCs*), with controllers in charge of flights while en route
4. Flight service stations (*FSSs*) with flight service specialists providing services such as flight plan filing preflight and inflight weather briefings to general aviation pilots

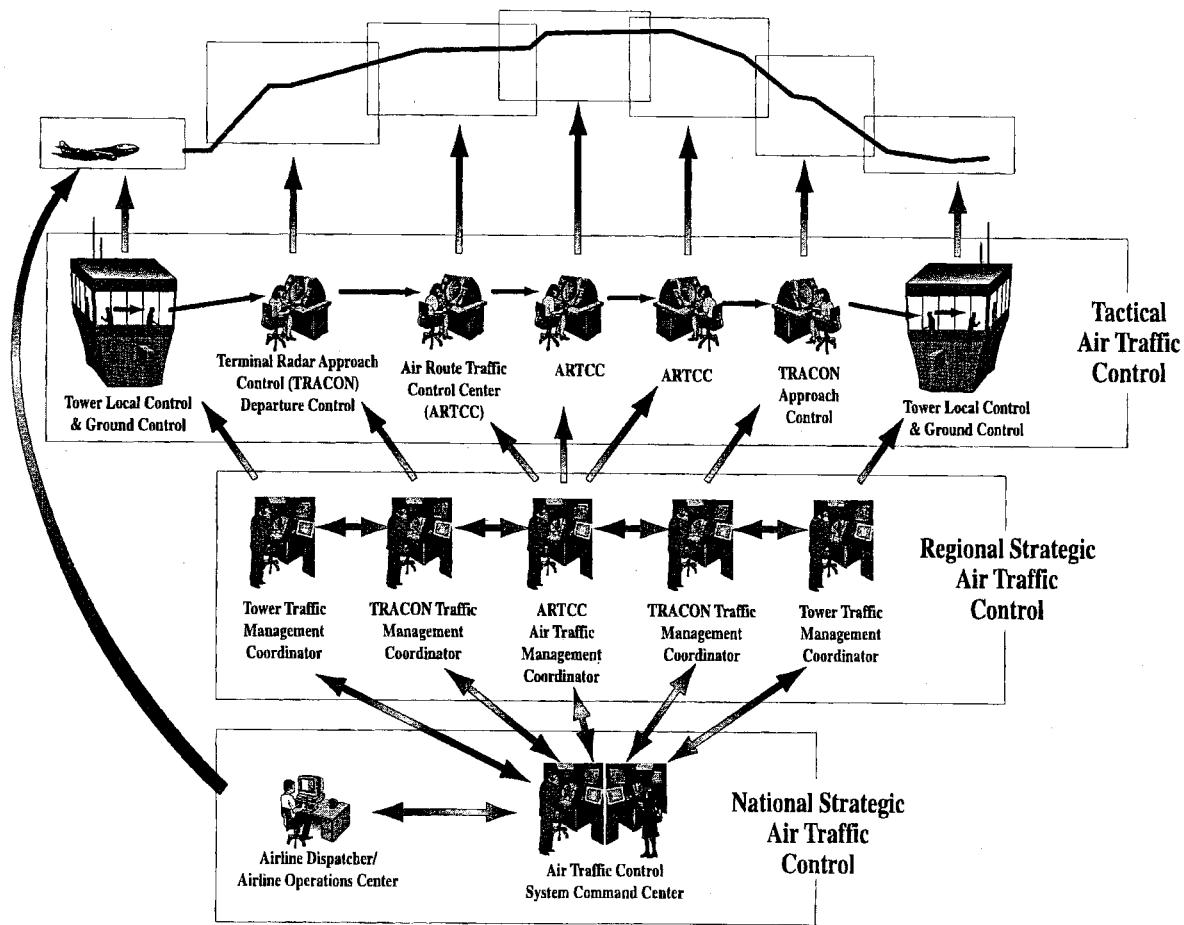

FIGURE 34.2 Representation of air traffic management organizational structure.

Pilots file a flight plan and obtain a clearance in order to fly through airspace controlled by the system. Once the initial clearance has been obtained, the pilot maintains radio communication with the controllers at these facilities to receive ATC services. The controllers monitor specific flights within the airspace (sectors) that they are in charge of and issue instructions to pilots in order to ensure safe separation and efficient use of the airspace.

At an intermediate level of organization, the ATM system includes local TFM units. Each ARTCC and TRACON also has a traffic management unit, and there are a few towers where traffic management coordinator positions have been established. These organizations are responsible for helping to plan and adjust the flow of traffic within their airspace.

At the national level, a centralized facility, the Air Traffic Control Systems Command Center (ATCSCC) coordinates the activities of the local units (Garland, Hopkin, and Muller, 1996). Finally, the dispatchers within airline operations centers (AOCs) have an increasingly significant impact on traffic flows, and thus must be considered in any discussion of the system. Details on the tactical and strategic operations within this structure are discussed in the following sections.

34.3 Human Factors in Air Traffic Control

The function of the ATC system is to provide safe, orderly, and expeditious flow of air traffic to its users. In accomplishing this function, the ATC system operates on two fundamental principles. First, the system exists to serve the users. The users are the pilots, aircrews, and passengers on board the aircraft being controlled by the system, plus the owners and operators of the aircraft. Control of aircraft by the ATC system also benefits operations of aircraft not being controlled directly, because ATC operations provide a systematic environment in which such “non-controlled” aircraft may be flown safely and efficiently.

Second, the system’s direct service is provided by the controllers. This service consists of outputs which include the following:

1. Clearances and control instructions
2. Advisories on traffic or other flight conditions
3. Manual flight data handling, including keyboard entries, handling of entries on Flight Progress Strips or notepads or other flight data displays
4. Controller-to-controller voice coordination and controller–pilot voice communication
5. Plans for and selection of control techniques and actions

In addition, first-line supervisors in ATC facilities support and coordinate the operational outputs of the controller positions, including coordination of requests for traffic volume control and metering services (Kinney, Bell, and Ditmore, 1982).

As discussed earlier, the ATM system has evolved a specialized, hierarchical structure in which the traffic flow management (TFM) component works to simplify and expedite traffic flows, ensuring that the operational environment is compatible with the capabilities of the controllers and pilots responsible for conducting tactical flight operations. Safety or separation assurance is the first aim of the ATC component of the ATM system. Efficiency is second, implying orderliness more than expedience.

Controllers collaborate with pilots to provide ATC services to participating (commercial, general aviation, and military) aircraft during takeoff, while en route, and upon landing. The nature of the controller’s mission, the ATC organization, the technological systems, and the operating environment vary across the different ATC facilities that support aircraft during each of these flight phases.

The following section describes the organizational, technological, and operational environments in which controllers are embedded. It also discusses factors such as mission requirements and operational constraints that affect the performance and workload of controllers. For each environment, examples of human factors and ergonomic issues are also discussed.

Type of Facility	Terminal Area Facilities		En Route Facilities	
Controlling Facility	Airport Traffic Control Towers	Approach Control Facilities	Air Route Traffic Control Centers (ARTCCs)	
Type of Control	Ground Traffic Control Takeoff and Landing Control	Approach and Departure Control	ATC during Transition and Cruise	
Airspace	Airport Traffic Area Typically 5 nmi and 3,000 ft AGL	Approach Control (Tracon Area) Typically Extending Up to 40 nmi and 10,000 ft msl from the Airport	En Route Airspace Transitional Phase Typically 50-150 nmi from Airport	
			Cruise Phase Up to 60,000 ft	
Typical Flight Time	Typical Ground Time 5-10 min	Typical Flight Time 10-20 min	Typical Flight Time 10-20 min	Typical Flight Time 20 min to Several Hours
Flight Profile				

FIGURE 34.3 The role of terminal and en route facilities in ATC. (From Mundra, A.D. 1989. A Description of Air Traffic Control in the Current Terminal Environment. MTR88W167, The MITRE Corporation, McLean, VA. With permission.)

Missions and Tasks within the ATC System

Air traffic control specialists or controllers may work in one of three areas: terminal, en route, or flight service. The terminal area includes controllers working in the airport traffic control towers (henceforth called simply towers) and the approach control environment. The en route area includes controllers working in ARTCCs or en route centers that manage the domestic and the oceanic airspace environments. The flight service area includes specialists working in FSSs that provide a variety of information and support services to general aviation pilots throughout the system. Because the flight service specialists do not provide services to active flights operating under the control of the ATC system, they are not discussed further in this section.

Figure 34.3 shows the role of the terminal and en route areas by depicting the ATC phases through which an aircraft passes from its point of origin to its destination (Mundra, 1989). Towers control the surface movement of aircraft and their landings and takeoffs. Once an aircraft takes off and before it lands the aircraft is under the control of the terminal radar approach control (TRACON). TRACON airspace generally extends about 40 nautical miles from the airport. Outside of this region, an en route center has responsibility for control of the flight. The cruise phase of an aircraft may be conducted within one or more centers. For international flights, the aircraft may pass into oceanic airspace and be handed over to an international control facility. The oceanic airspace is divided into flight information regions operated by non-U.S. civil aviation authorities.

Terminal Environment — Tower Operations

The FAA operates over 400 towers to control traffic on airport runways and taxiways and in the immediate vicinity of the airport. ATC in the tower is based on the visual confirmation and pilot reports of aircraft locations and face-to-face-interaction between controllers. Tower equipment types vary depending on each facility's operational needs, and the equipment configuration is often customized to a given tower's structure. As in all ATC environments, flight strips are used to record, maintain, and coordinate flight plan and clearance data. Many towers also have radar displays to aid visual acquisition of arriving aircraft, surface surveillance equipment for displaying aircraft locations on the airport surface, and a data link communications system for transmitting selected messages to pilots.

The tower may be staffed with a local, ground, clearance delivery/flight data, and supervisor position. Each position has different responsibilities depending on an aircraft's phase of flight. Only the local and ground controllers have traffic movement responsibility.

For departing aircraft, the flow of information and responsibility goes from flight data/clearance delivery to ground control and then to local control. The flight data/clearance delivery position processes flight plan data and manages the predeparture clearance (*PDC*) process. This process ensures that the aircraft has received current airport information (the Automatic Terminal Information Service (*ATIS*)) and an approved flight plan. At most major airports, controllers prepare digital messages and pilots request the *ATIS* and *PDC* by using a data link. The ground controller is responsible for issuing the taxi clearance and directing the aircraft through the system of taxiways that lead to the runway. The local controller has responsibility for the active runway and clears the aircraft for takeoff.

For arriving aircraft, the flow goes from local to ground control. The local controller clears the aircraft to land and issues instructions regarding where the aircraft should exit the runway. The local controller then directs the movement of the aircraft toward a gate.

Research on the tower operations highlights some characteristics of the environment that have important effects on controller performance and workload. Tower controllers spend a considerable amount of their task time, approximately one-third, visually tracking traffic movements outside the tower (Bruce, 1996). The task of visually tracking aircraft and knowing how to communicate with them is not a trivial one (Wickens, Mavor, and McGee, 1997). It entails extensive cross referencing of display aids, controller movement around the tower to view aircraft movements, and face-to-face interactions with the other controllers. Although tower controllers accomplish many tasks concurrently such as moving flight strips and cueing the radio microphone while looking out the tower cab window, they do not conduct keystroke entries or read display information.

For several years, the FAA and the National Transportation Safety Board have been concerned with reducing runway incursions and related surface incidents. These incidents may result from a variety of causes, including errors made by controllers as a result of reduced visibility. Display-based aids for detection of unauthorized movement of aircraft on runways are now being deployed by the FAA. However, because tower controllers have a major responsibility to continuously scan the terminal airspace, such aids must be carefully integrated with the controller's visual and auditory scanning tasks (Bales, Gilligan, and King, 1989).

Another important characteristic of the tower environment is that it is communications-intensive. Tower communications are generally time sensitive and often time critical. During busy periods, a tower controller accomplishes time-critical communications at a rate only marginally ahead of air traffic movements around the airport. Moreover, the only way tower controllers can manage their workload in heavy traffic situations is to delay aircraft movements (Bruce, 1996). Analyses of tower communications indicate that a variety of factors are adversely affecting the pilot's ability to correctly understand and remember controller instructions (Adam, Kelley, and Steinbacher, 1996; Burki-Cohen, 1995). In order to minimize time on the radio frequency at busy times, there is a tendency for controllers to speak more rapidly, making it difficult for pilots to understand messages. Furthermore, many of the messages transmitted by tower controllers, such as taxi instructions, are complex and lengthy, making them difficult for pilots to remember. Finally, frequency congestion, a pervasive problem at busy towers, often prevents

pilots from reading back their instructions to ATC, eliminating the verification that the pilot has heard and understood the instructions.

Terminal Environment — Approach Control

Approach control facilities provide ATC services to arrival and departure aircraft transitioning between the tower and the en route airspace. In most busy terminals, the TRACON room is housed in the same building as the tower. ATC in the TRACON, as in the en route domestic airspace, is primarily radar based. However, the equipment, traffic environment, and control procedures used in the TRACON are quite different from those in the en route environment. The automated radar terminal system equipment which provides a radar display of air traffic is fairly standard across facilities, but system capabilities may vary somewhat depending on the level of traffic handled by the facility. Flight strips are also used in the TRACON.

A typical TRACON control room includes two arrival feeder, two final, and two departure positions. Each position is assigned responsibility for a sector of airspace with arrival and departure traffic segregated into dedicated airspace corridors. The arriving traffic in the terminal area funnels in from higher altitudes and speeds for landing. The arrival controllers sequence and space the aircraft. A pair of arrival or feeder controllers each work the arriving traffic for one side of the airspace, e.g., north or south arrivals, establishing the aircraft on their initial approach to the airport. Two final controllers, one for each side, are responsible for the final approach phase.

The departing traffic fans out to higher altitudes and speeds for the cruise phase. Departure traffic is also divided between two departure controllers who each work one side of the airspace, establishing the aircraft on headings to the planned route of flight.

The physical layout of the TRACON reflects the degree of coordination required between operational positions. The four arrival positions work as a team and are situated next to each other. The final controllers are next to each other, as they typically need to coordinate frequently. The arrival feeder controllers are each situated next to the final controller they feed. Departure positions are separated from the arrival positions, mirroring the segregation of arrival and departure traffic.

Mundra (1989) identified several characteristics of the TRACON operating environment that affect the performance and workload of the controllers. There is high frequency of aircraft maneuvering in altitude, speed, and heading, and a rapid convergence of many traffic streams. Once within the TRACON airspace, aircraft are neither expected to nor allowed to follow a predefined route; instead control is exercised through headings (i.e., vectoring), altitude, and speed instructions. As a result, system performance is sensitive to controller skill level in planning and achieving throughput and aircraft efficiency (fuel-efficient speeds, altitudes, or paths).

The TRACON lacks planning data and a route structure on which to base flight planning for individual aircraft. Instead, it uses a vectoring plan that only the controller knows. Today, the path flown is a specific response to a tactical situation, and must be visualized in the controller's mind. The controller must also keep track of the situation and required actions under high workload conditions.

Because of the high frequency of controller-initiated maneuvering, voice communication is a significant portion of the controller's workload. This implies many of the same communication problems discussed in the preceding section.

The uncertainty and rapid pacing of activity in the TRACON environment requires flexibility and teamwork. The limited advance information on controlled traffic and the lack of any advance information on uncontrolled traffic means that controllers must respond quickly to adapt their plans and fit in new traffic and share or redistribute tasks.

En Route Environment — En Route Domestic

The FAA operates 22 en route centers to separate aircraft traveling between airports. The host computer system, display equipment, and facility designs in the en route centers are standardized. ATC in the en route centers is radar based and each operational position is equipped with a radar display of traffic and flight strips. However, this common equipment configuration accommodates a wider range of staffing

plans, missions, and tasks than is found in other ATC environments. En route centers provide an ATC link with other centers, with TRACONS, and with towers. As in the TRACON, the physical layout of the sectors in the en route facility reflects the degree of coordination required between controller positions.

En route ATC operations are divided into various types of airspace sectors. Each operational position is assigned responsibility for a sector and each sector may be staffed with one to three controllers, depending on the volume of traffic. When multiple controllers work a sector, task assignments vary among teams. Typically, a radar (R) controller is in charge of the sector operation. This controller uses the radar situation display and voice communications to apply radar separation procedures and separate the aircraft from all others within the sector. A radar associate or data (D) controller is responsible for separation planning activities. The D controller uses flight strips which provide advance information on the aircraft's planned route and interphone communications with other controllers to identify potential problems and coordinate preventive control actions. When the sector is too busy for the R and D controllers to handle, a radar coordinator (tracker) or handoff (H) controller may share the R controller's load, serving as a redundant "set of eyes and ears" to support situation monitoring and as a second pair of hands to perform data entry and intersector coordination tasks.

En route sectors can be classified into types according to various sector and duty characteristics. High altitude sectors, generally above 24,000 feet, handle departure traffic climbing to cruise altitude, overflying en route traffic flying level, and traffic descending to a lower level in preparation for arrival. Low altitude sectors normally have a mixture of aircraft which fly at lower altitudes, slower speed arrival and departure traffic, and higher performance aircraft transitioning to the high altitude sectors. Within these two broad divisions, finer breakdowns can be made based on the homogeneity of the traffic flows and the sector's mission. For example, en route arrival/departure sectors coordinate traffic flow in and out of approach or airport control; transition high and transition low sectors have a majority of their traffic climbing or descending to reach cruise altitude; and en route high and en route low sectors have most of their traffic flying level.

Controller tasking and taskload in different sectors results from a combination of static and dynamic factors. Static factors, such as the type of traffic flow and the service that must be provided each aircraft, imply routine tasks that are known in advance and performed for every aircraft or for a specific subset of the traffic such as a particular flow. For example, en route controllers currently have a major responsibility to implement routine ATC procedures, such as routing and altitude constraints specified in interfacility directives, and flow management procedures to establish an orderly flow of traffic within the airspace. Dynamic factors are associated with the particular airspace delegated to the sector (e.g., size of the airspace for radar vectoring, time an aircraft remains in the sector), the number and characteristics of aircraft within the airspace, and the nature and frequency of requests by users to alter their flight plans. One dynamic factor thought to be an important determinant of complexity involves the number and pattern of potential conflicts that can occur within the sector airspace for a given period of time. The decision-making process associated with the detection and resolution of conflicts has a great impact on determining controller workload and sector capacity.

In the current environment, a mix of procedural solutions and automated capabilities is used to anticipate and manage complexity and controller workload. On a scheduled basis, controller positions are closed and opened and responsibility for sector airspace is combined and decombined under a position. Staffing arrangements also vary with sector load. During busy rush periods throughout the day, en route sectors are routinely staffed with two and sometimes three controllers. When traffic volume is expected to exceed the sector's capacity for an extended period of time, traffic flow management is alerted by an automated monitor alert function and procedures are activated to limit the volume of traffic handled by the sector.

The controller's ability to manage traffic in the current environment is also affected by equipment. The three-person sector team poses problems in performance because the sector equipment is set up and laid out for a two-person operation and is awkward for three-controller staffing (Kinney, 1977). For example, when the H controller sits down, the R controller moves farther away from the flight strips and has difficulty reading them. The three-controller operation also requires coordination between the R and

H controllers, a task that does not exist with the two-person sector. In general, the fact that equivalent tools and technological capabilities are not available on each side at the en route position limits the ability of the assistant controllers to contribute substantially to team performance (Shingledecker and Darby, 1995). Finally, the outdated message composition, editing, and list management capabilities available on the workstation may be contributing to deficiencies in controller performance with manual inputs. Early research on manual data entry tasks indicated that these tasks which make up a large part of the controller's workload are demanding and time consuming and that data entry errors appeared as contributing causes in many system error case histories (Kinney, 1977).

En Route Environment — En Route Oceanic

The FAA also provides ATC service within a large area of international airspace, including the western half of the Atlantic Ocean, the Gulf of Mexico, and a significant portion of the Pacific Ocean (Nolan, 1990). In contrast to the domestic en route airspace, oceanic airspace has no radar coverage over most of the area. For this reason, monitoring and control of the oceanic traffic is based on flight plan data, position estimates, and relayed voice position reports from the pilots. Route structures are used to impose order and separate the traffic flows. In addition, controllers apply a diverse set of nonradar separation criteria to provide ATC services over the ocean. Paper flight strips constitute the primary information display for aircraft separation; these are updated by controllers with the current flight plans and latest position reports for each aircraft. The oceanic computer system also provides a plan view display of traffic positions based on the pilot's reports. Unlike the other ATC environments, air-ground communications over the ocean are indirect. Controllers use a telecommunications processor to send messages to a service provider who relays them to pilots. The telecommunications processor is also capable of sending data link messages directly to aircraft via a satellite. In part of the airspace, controllers have begun to use the data link to communicate directly with pilots.

An oceanic controller is assigned responsibility for a sector of airspace. However, oceanic sectors are significantly larger than those in the domestic airspace environment (e.g., an oceanic sector may be several thousand miles in length) and a single controller may have responsibility for many more aircraft than in the en route environment. Procedural ATC requires large lateral and longitudinal separation between aircraft that takes into account the lack of timely, independent surveillance and the uncertainties and delays associated with the communications. Oceanic controllers plan for separation by mentally calculating fix crossing time differences between aircraft, based on flight strip data. If aircraft are not traveling on structured routes, controllers may evaluate separation visually on the plan view display or estimate distance spacing by plotting position data on charts (Coulouris, 1985). To ensure that the planned separations are maintained, controllers monitor flight progress based on pilot reports submitted as they cross compulsory reporting fixes (hourly or every 10 degrees longitude/latitude). With each progress report, the controller reexamines the traffic situation and searches for potential conflicts.

Hamrick and Reiersen (1993) discuss some characteristics of the oceanic environment that affect the controller's performance and workload. Separation planning is complex and must allow for uncertainty and delay. It often requires that controllers plan a sequence of clearances involving several aircraft in order to enable aircraft at different altitudes on the same route to climb or to merge traffic onto a single route.

Separation assessment entails significant mental calculations of fix crossing time differences and often requires cross referencing and integrating information from multiple sources to form a single "picture" of the situation. A variety of techniques and separation standards are currently applied in the oceanic airspace (FAA, 1992). Determining the applicable separation criterion is not a trivial task. It requires consideration of multiple factors, such as aircraft type, method of navigation, altitude, geographic region, speed, route of flight, flight origin, and destination. In some regions, many standards apply and the controller will select the standard that provides the best operational advantage in a given situation.

Today's oceanic controllers have few tools, and automation is limited to use for traffic visualization not separation. Use of flight strips as the primary means of separation means that controllers have a considerable taskload in bookkeeping pilot progress reports and monitoring for overdue reports. At times,

oceanic sectors have so many flight strips that the controllers must stand and walk back and forth to examine and update the flight data. At the same time, the large sector sizes that must be accommodated on the plan view display cause aircraft positions to appear to be in close proximity, making it difficult to determine if aircraft are separated just by monitoring a situation display. Because the communications system is slow and cumbersome, controllers must take extra precautions in planning separation strategies that minimize the need for communication.

Missions and Tasks within the ATC System — Summary

In all areas of ATC, controllers operate as part of a system of interacting components. These components include: the airspace and airport surface layouts, communications links, information display and management tools, and procedures, as well as pilots, other controllers, and traffic managers. Human factors and ergonomics issues in ATC arise as a result of controller interaction with each of these components. The present system is characterized by standard operating procedures that establish an orderly flow of traffic within the airspace, and controllers rely on this traffic organization to anticipate problems and manage separation. Yet, against this basic traffic organization, the process of separation planning and selection of control techniques is highly dependent on the controller and varies across environments with respect to the temporal demands and information processing and response resources involved. While the basic information required by controllers is fairly constant across environments, the quality and format of information available varies across the domains. Overall, the best information is available in the en route environment, but there is also a controller cost associated with maintaining the data. Throughout the system, air-ground communications is a demanding controller task and capacity limitations in the current communications links contribute to information transfer problems. For the most part, controllers are working with aging equipment. Equipment-related issues vary across environments, but they include lack of information integration and inefficient display formats, workstations, and equipment layouts that impede team coordination, and outdated data handling capabilities that induce errors and reentry of data. Controller and pilot workload tends to be concentrated in busy environments such as the tower and the approach control. In these busy environments, where there is a concomitant need for controllers and pilots to coordinate their activities, it is particularly difficult to time the information exchanges so that they do not interfere with higher-priority duties.

Ergonomic Issues in ATC

There is a sizable body of research literature on ergonomic issues in ATC (see, for example, Wickens, Mavor and McGee, 1997; Hopkin and Wise, 1996; Hopkin, 1988). This section focuses on the relevance and application of this research in the context of new and emerging ATC capabilities.

Some of the main ergonomic issues in ATC relate to the mental demands and uncertainties imposed by the ATC process and the environments in which the controller is embedded. Complexity management and control strategies are key issues in this area. Another source of issues relates to the cooperative nature of the activity (Leroux, 1995). Information transfer and communications are key issues in this area.

Complexity Management

Current air traffic control systems are functioning near, at, or even beyond their planned maximum traffic handling capacity, and all current projections foresee continuing and cumulative increases in air traffic for a long time (McAlindon and Gupta, 1993). Consequently, there has been a longstanding interest in understanding and quantifying the controller's traffic handling capacity and in predicting when this capacity breaks down. However, despite a lengthy history of research on controller workload and sector complexity, the operational relationship between the two concepts remains elusive, and practical application of complexity measures in the current system is limited. Today, the most widely used complexity measure is based exclusively on aircraft counts. In the field, operational decisions on complexity management continue to be made by instinct and local judgment.

Several factors make the analysis of controller workload in the current system a complex matter (Wickens, Mavor and McGee, 1997). Controller taskload has been analyzed extensively to derive traffic

and airspace characteristics that predict workload; however, this approach seems to be most applicable to measurements of the observable, motor, and manual components of workload. Research on workload has also shown that successful controllers use various adaptive strategies to manage their performance in the face of increasing complexity (Sperandio, 1971). These adaptive strategies allow the controller to handle more aircraft without error or excessive workload. Furthermore, research relating complexity and workload to operational errors tends to confirm that this relationship is probably mediated by other factors, such as control strategies. Studies of operational error reports show that errors are not uniquely associated with high complexity and workload but also occur under low to moderate complexity and workload (Canadian Aviation Safety Board, 1990; Rodgers, 1993; Kinney, 1977). However, one of the chief difficulties encountered in interpreting the error reports is that there are no normative data. The relative frequencies of the levels of traffic volume and complexity are unknown, which precludes determining whether or not the reported frequencies of errors in these levels are disproportionately related to chance.

On one hand, these results emphasize the great need for better baseline and normative data on human and system performance as standards for evaluating causal relationships (FAA, 1995; Benel, 1995; Galushka et al., 1995). On the other hand, they may suggest a practical problem with the research questions (Sarter, 1996). From the standpoint of complexity management, it may be more useful to focus on prediction of complexity with respect to a specific operational context and decision. At a tactical level, controllers need detailed information on current and predicted sector complexity to plan control actions. Supervisors need information on predicted complexity for multiple sectors in order to plan for staffing. At a more strategic level, traffic managers need summary information predicted over a longer period of time and for a larger area to plan for flow management procedures and programs (Klein, 1992).

Controller needs for complexity information are being addressed by development programs in the U.S. and in Europe (Schultheis and Tucker, 1996; Makins and Drew, 1995). Both programs are developing controller tools for conflict prediction and resolution. With these tools, an indicator of sector complexity is provided in the form of display information on the number of predicted conflicts and their temporal distribution. Currently, both the U.S. and Europe rely on a second controller to plan traffic and ensure that the primary controller is not overloaded. Advance information on conflict resolution workload should allow the second controller to better schedule and manage conflict resolution tasks. Such tasks account for a significant and increasing component of the primary controller's work. Particularly in the U.S., where the ATC environment is gradually evolving away from structured routings toward user-preferred routings, the relative contribution of the conflict resolution to overall sector workload is likely to increase, making it a better predictor of complexity (Carlson, Rhodes, and Cullen, 1996). The ultimate goal for future ATC is a control-by-exception paradigm in which controller interventions are limited in extent and duration to correct identified problems (RTCA, 1995).

Control Strategies and Efficiency

The growing demand for aviation services and the constraints on budget that both the industry and the FAA face have stimulated interest in improving the efficiency of ATC. As mentioned in the preceding section, controllers cope with increasing traffic demand and complexity by employing adaptive strategies. Research on controller strategies has identified how specific adaptations tend to lower the efficiency of individual flights and the overall traffic flow when demand is high. New ATC capabilities are helping reduce the need for these specific adaptations and preserve flight efficiency.

In general, strategies that are economical for the controller are those that preserve the primary objective of safety but take less account of secondary objectives such as flight efficiency, user-preferred paths, and fuel economy path (Bruce, 1996; Bellowini and Decortis, 1995). Early on, Sperandio (1971) showed that controllers handled an unexpected increase in traffic load by adaptively decreasing the amount of time they spend on each aircraft. For example, the controller may structure the traffic so that all of the flights are in-trail and traveling at a uniform speed, thereby reducing the difficulty of monitoring for conflicts.

Another way controllers adapt their strategies is to focus on the immediate tactical situation and abandon planned strategies. To plan and execute control strategies that are more flight efficient, controllers

must coordinate with each other. Under high workload, a shift from cooperative toward individual work has been observed in both the TRACON and en route environments. Bellorini and Decortis (1995) found that in the TRACON environment controllers shed coordination tasks under high demand, resulting in less efficient sequencing of arrival aircraft. Sperandio (1978) observed that in the en route environment, both sector controllers focus attention on the current tactical situation, reacting quickly and employing less efficient tactical control techniques. He further notes that an increase in the workload in the sector tends to make the support tasks more and more dependent on the central task and tends to overload the principal operator even more, so that the assistant becomes less and less efficient at a time when he is more and more necessary.

Controller–pilot coordination may also increase as controllers abandon planned strategies and react to the tactical situation. In many traffic situations, reactive strategies are communications intensive, with the controller assuming greater responsibility for flight paths and making continuous tactical adjustments. Increased communications tax the controller's perceptual, cognitive, and speech motor capacities and the pilot's ability to understand and respond to instructions, resulting in more frequent requests for repetition and clarification (Shingledecker and Darby, 1995; Adam and Kelley, 1996).

To preserve flight efficiency, a more proactive approach to ATC is desirable. Decision support tools for tactical planning and selection of control strategies are being tested in the en route and TRACON environments. As mentioned in the preceding section, the FAA is currently testing a conflict probe capability to provide early detection of conflicts and tools for conflict resolution in the domestic en route environment (Schultheis and Tucker, 1996). A similar capability is also under development for the oceanic environment (Hamrick and Reiersen, 1993). This capability will reduce the mental calculations and extrapolations involved in separation monitoring and afford a longer lead time to plan resolution maneuvers that are less disruptive to the user's flight intent. Team performance will be aided by providing the assistant controller with more powerful tools for visualizing the future traffic situation and evaluating proposed maneuvers. In addition, an automated coordination aid will also allow controllers to share and approve plans.

In the TRACON, controller aids for merging flows and sequencing aircraft for approach are already in use or under test at field facilities (Mundra and Levin, 1990; Lee and Davis, 1995). These tools provide advance information on the predicted sequence of arrival aircraft. One tool, the converging runway display aid (*CRDA*), has been deployed to assist the controller in conducting staggered approaches. Staggered approaches require specific separations between aircraft landing on adjacent runways as well as between in-trail aircraft. Staggered approaches have been characterized as more complicated than simultaneous approaches which have only in-trail spacing requirements (FAA, 1991). The *CRDA* reduces the complex mental calculations and extrapolations involved in staggered approaches by projecting false targets or ghosts for aircraft arriving in one of two converging streams onto the other stream, thus allowing the controller to visualize and manage simple in-trail spacing on a single approach.

Another tool, the final approach spacing tool (*FAST*) is one element of a Center TRACON Automation System (*CTAS*). *CTAS* comprises a set of tools to assist controllers handling aircraft arrivals starting at about 200 n.mi. from the airport and continuing to the final approach fix. *FAST* provides the controller with landing sequence numbers and runway assignments to achieve an accurately spaced flow of traffic onto the final approach course (Davis et al., 1991). Based on the displayed sequence, the controller formulates appropriate instructions for merging and spacing the arrivals. Research indicates that *FAST* advisories improve the runway delivery precision and reduce controller workload by reducing the number of vectors issued to each aircraft and reducing the need for (verbal) coordination between controllers (Credeur et al., 1993; Lee et al., 1995).

Communications

There is ample evidence in the research literature that controller–pilot communications are a common and persistent problem in today's operations (Kerns, 1994). Analyses of incident and error reports and of recordings of routine controller–pilot communications offer a cogent explanation of how often and why problems occur. Field experience and simulation studies on data link offer a useful perspective on how this technology can be used in the operational environment to improve communications.

Some of the primary factors which contribute to communications problems arise from the use of spoken language to transfer information. ATC communications have been designed to ensure that spoken dialogues can be conducted efficiently and with minimum possibility of error or misunderstanding (Hopkin, 1988). Controllers and pilots have adopted a standardized phraseology, language conventions, and procedures which define the process for conducting the dialogue, including the cues that tell a listener when a transaction has been completed and whether a readback is required. However, despite years of refining the language and procedures, research confirms the intractable nature of many of the problems inherent in the exclusive use of spoken language for controller–pilot communications. Grayson and Billings (1981) analyzed aspects of human speech processing and conversational behavior that mediate communication performance. Their analysis found that a tendency to fill-in information, the expectancy factor, and timing problems were implicated in many types of controller–pilot communication problems. The expectancy factor contributes to misinterpretations and inaccuracies because controllers and pilots sometimes hear what they expect to hear. This generates what have been called “readback and hearback” errors in which, respectively, a pilot perceives what he expected to hear in the instruction transmitted by the controller and a controller perceives what he expected to hear in the readback transmitted by the pilot.

Congestion on the voice radio frequency has also been implicated in communications problems. During busy periods, controllers issue longer, more complex messages in an attempt to minimize use of the radio frequency. However, as more transmissions are crowded onto the frequencies, the procedural steps (callsign identifications, readbacks) that assure communication are being dropped (Adam, Kelley, and Steinbacher, 1994; Cardosi, 1993). Analyses of routine communications (Morrow et al., 1993; Cardosi, 1993; Cardosi, Brett and Han, 1996) have highlighted the contribution of message complexity and the resulting memory burden to miscommunications. In both the terminal and en route environments, errors and procedural deviations increased as clearances increased in complexity.

The frequency congestion problem is most pronounced in the tower environment where controller transmission rates have been observed at 3.9 and 8 transmissions per minute for the local and ground controllers, respectively, as compared to 1.8 transmissions per minute in the en route environment (Burki-Cohen, 1995). A concentration of controller and pilot workload in the tower environment also accounts for failures to transmit information and untimely transmissions in busy environments. Because of high workload, controllers may fail to initiate lower priority traffic advisory messages, precisely when the pilot’s need for this information is greatest. Conversely, pilots may be preoccupied with external vigilance and flight control tasks. They may not wish to receive messages and may fail to respond.

One of the ways the FAA is responding to communications problems is by developing alternative means of information transfer. Data link communications have already been introduced in environments where communications problems and limitations are the most severe: the tower and the oceanic en route. The PDC and the ATIS are being transferred via data link at many major airports. Direct controller–pilot communications via a satellite data link are being conducted in the oceanic airspace. The selection and design of these services have benefited directly from research on human interaction with voice and data link communication systems (Kerns, 1991;1994).

Research indicates that data link offers several advantages for transfer of lengthy, repetitive messages such as PDC and ATIS. Data link capabilities for message storage and retrieval reduce the controller’s burden when preparing messages and the pilot’s memory burden when receiving them. Data link also allows controllers and pilots to pace the transmission and processing of the information, thus avoiding conflicts with higher-priority tasks.

In the oceanic environment, the tempo and highly structured format of the controller–pilot communication is well suited to data link transmission. The design of the controller and pilot data link communication protocols and their message-handling capabilities have also been guided by data link simulation research (Kerns, 1994). Based on the study results, operational communication protocols that minimize switching between voice and data link media have been implemented. Moreover, the procedural steps required to conduct communications within each medium are consistent. In terms of the level of automation, message-handling capabilities have been designed so that controllers and pilots have the final authority to approve the transfer of information to each other and to their automation systems. At

the same time, computer aiding of message composition has been implemented using menu style user interfaces to minimize input errors and relieve the human operators of these functions.

Although the experience and results to date indicate that these initial applications of data link offer important operational benefits at little or no cost to the human operators, future applications of data link must be selected carefully, addressing key human engineering challenges. Visual display and manual control of transmitted information may not be appropriate in environments where the controller or pilot visual and manual resources are already reaching an overload state. Delay factors associated with message composition may limit the utility of data link in rapidly changing conditions while transmission delays may limit its utility for time-critical transmissions. Finally, new procedures will be needed to maintain team performance when the communication medium is silent and may be less readily observable by multiple operators.

34.4 Human Factors in Traffic Flow Management

The function of the traffic flow management (TFM) system (Nolan, 1990; Odoni, 1987) is to provide strategic planning and control when necessary to try to avoid situations where potentially unsafe or inefficient operations are likely to arise. As discussed earlier, within the United States (which is the ATM system that will be used to provide examples in this chapter), the FAA has organized this system into a hierarchical structure including ATCSCC (which supervises and coordinates planning at a national level), traffic management units at en route centers and TRACONs, as well as FAA staff at towers and airport facilities. In addition, although not a formal part of the FAA's TFM system, AOCs (Airline Dispatchers Federation, 1995) play an increasingly important role in influencing traffic patterns.

Sample Control Methods within the TFM System

To make the concept of TFM clearer, several examples are provided below.

Predeparture Interventions by ATCSCC

There is a variety of situations where the normal flow of traffic into an airport or some portion of the airspace needs to be restricted, and where information is available early enough to change plans before the affected flights depart. Such situations include forecasts of bad weather (thunderstorms, low visibility at an airport, etc.), runway restrictions or closures, and forecasts of heavy traffic congestion.

Under such circumstances, traffic managers at ATCSCC (in consultation with the affected traffic management units) may choose to employ a variety of procedural tools to reduce traffic. They may, for example, initiate a ground delay or ground stop for flights departing from airports within one or more centers. Alternatively, they may prevent AOCs from filing flights along a particular jet route or may reduce the flow of traffic along that route by requiring additional spacing between aircraft (for instance, requiring aircraft to fly 25 miles-in-trail). They may also give an airline several options to choose from in filing a particular flight.

Predeparture Interventions by AOCs

When capacity-limiting situations arise, the airlines may also choose to change their plans without any intervention by ATCSCC. They may, for example, cancel a number of their flights to a particular airport that is expected to have a reduced arrival rate due to bad weather, because a failure to do so could result in expensive diversions of some of their flights. Similarly, they may choose to file their flights along an alternative route because they are forecasting poor weather along the normally preferred routing.

At the other extreme, they may choose to file a few additional flights over and above the forecast arrival rate for an airport expected to have bad weather in order to provide a "reservoir" of flights to take advantage of the situation if the forecasted bad weather does not develop. (In this latter situation, they run the risk of having to divert these additional flights if the forecast weather does develop, and must fuel the aircraft to handle the resultant diversion to an alternate airport.)

Interventions While En Route

Situations also arise that require interventions while flights are airborne. As examples, traffic managers at en route centers may ask controllers to reroute certain flights to avoid predicted traffic congestion somewhere further along their routes, or may impose metering over an arrival fix, limiting the number of flights arriving at that fix within some period of time. Airline dispatchers may similarly request their flight crews to request rerouting if they foresee some problem further along the route.

Sample Actions — Summary

The point of these examples is, first, that strategic planning decisions are made to try to avoid situations that could affect safety or efficiency. A second point is that there is a variety of alternative tools to influence traffic flow. A third is that, in the current TFM system, some of the decisions are made by FAA traffic managers, while others are made by individual AOCs (and that these decisions clearly interact with each other to determine the ultimate impact on traffic flow).

Traffic Flow Management — Conceptual Framework

To better understand the interactions of these organizational units that make up the TFM system, and to understand the performances of the individuals within them, it is useful to describe it as a distributed cognitive system, where the primary task is planning in the face of uncertain events. It is distributed in many senses, both within these organizational units and across them (Layton, Smith, and McCoy, 1994).

Distributed Problem-Solving

There are many senses in which TFM can be viewed as a distributed problem-solving task (Davis and Smith, 1983). First, the organizations (ATCSCC, ARTCCs, TRACONS, Towers, and AOCs) are geographically separated, so that direct face-to-face communication cannot occur. Second, in many cases, information access is distributed among these different organizations, so that a traffic manager at an en route center may not have the same information as a dispatcher at an AOC or a specialist at ATCSCC. Third, different types of knowledge or expertise are distributed among these organizations. Fourth, different types of decision-support tools are available at the different organizations.

Tasks and responsibilities are not only distributed across organizations, they are also distributed within organizations. There are specialists at the command center to deal with weather forecasting, to design severe weather avoidance programs, etc. Similarly, dispatchers at AOCs have responsibility for developing flight plans for flights in different parts of the world, and interact with airline meteorologists and specialists with expertise in such things as aircraft maintenance, crew scheduling, and aircraft scheduling.

Competing and Complementary Goals

Another important characteristic of this cognitive system is that different organizations and individuals have different goals and priorities. FAA traffic managers have as their primary responsibility ensuring traffic flows that allow the safe separation of traffic from all sources (commercial airlines, general aviation, and Department of Defense flights). They are also concerned with the efficient use of airspace capacity. Some of the decisions they make further require consideration of equity among the different airlines.

AOC staff likewise have the safety of their flights as the most important consideration. However, within that constraint, their goal is the efficient and effective operation of their own airline's schedule, as they are in competition with the other airlines.

Thus, even from a broad systems perspective, disagreements between FAA traffic managers and AOC staff must be expected. When constraints such as workload and information access further intervene, or when there are differences of opinion about weather or traffic forecasts, such disagreements are even more likely to occur.

Decision-Making Under Uncertainty

A third major factor that must be considered to understand human performance within the TFM system is the high degree of uncertainty associated with decisions. Weather is a major issue (Andrews, 1993),

whether it concerns a forecast regarding the development of a line of thunderstorms, a snowstorm closing east coast airports, strong crosswinds impacting a particular runway at an airport, or low visibility due to fog. There is also considerable uncertainty about traffic patterns. Flight departures are frequently delayed, for instance, which can influence traffic congestion at some further point along their routes, and there are numerous reasons why runway use at an airport must be restricted. Finally, controller staffing and workload limitations can introduce unexpected capacity constraints.

Conceptual Framework — Summary

In short, to cope with the complexities of managing traffic in the face of numerous sources of uncertainty, the TFM system has evolved into a very complex network of organizations and individuals where subtasks are allocated to specific individuals or organizations in order to reduce the cognitive demands on any one individual. This task decomposition includes considerable redundancy to catch errors and inefficiencies. This task decomposition also introduces all of the classic concerns associated with finding localized (suboptimal) solutions to problems, as well as the classic concerns regarding the strengths and weaknesses of group decision-making processes.

Ergonomics in TFM

The conceptual framework provided above begins to suggest some of the main ergonomic issues that arise in TFM (Wiener and Nagel, 1988). These concerns stem from the fact that this is a very complex group decision-making process under conditions with a high degree of uncertainty, and are highlighted in the subsections below. It is also worth noting that these same characteristics (the complexity resulting from a large number of factors interacting to influence performance, and the fact that it is the interaction of a network of organizations and individuals) have had a significant influence on the type of research conducted thus far. With a few exceptions (Layton, Smith, and McCoy, 1994), the research has been limited to descriptive observational studies of performance in field settings.

Goal Allocation as a Strategy to Reduce Complexity

To deal with complexity, the TFM system has been designed to distribute responsibility between FAA TFM facilities and the airlines by distributing responsibility for different goals. Traffic managers within the FAA have as their primary responsibility assuring safe and efficient use of overall system capacity. Thus, if an airport is predicted to have a reduced arrival rate due to a forecast of low visibility, ATCSCC, in consultation with the affected ATC facilities, will select a control strategy, such as an “all centers” ground stop for all flights to that airport for a certain period of time. This strategy is then simply imposed on the airlines, as ATCSCC has the ultimate authority in making such a decision. Under such a “control by directive” paradigm, the airlines’ business concerns are considered only in the limited sense that safe, efficient overall use of the system’s capacity is desirable from an airline perspective as well.

Such a paradigm reduces the complexity of the decision-making task faced by traffic managers, as they do not have to consider as many factors in making decisions. However, it also clearly can lead to suboptimal decisions from an industry perspective (as there can be several alternatives that are equivalent from a TFM perspective in terms of safety and overall use of system capacity, but which are quite different in terms of their economic impacts on individual airlines).

As a result, the system has been evolving toward formal procedures for incorporating airline preferences in TFM decisions (Lacher and Klein, 1993; Scardina, Simpson, and Ball, 1996; Wambsganss, 1995). Initial efforts in this regard focused on the process for approving the flight plans filed by airlines prior to departure. This evolution began in the early 1990s with the implementation of the National Route Program (Federal Aviation Administration, 1992). This gave the airlines a mechanism for requesting permission to file flights on routes other than FAA preferred routes. Such requests for “nonpreferred routes” were submitted to ATCSCC on a daily basis, and were evaluated for approval by command center specialists in consultation with traffic managers in the affected centers.

This “control by permission” paradigm maintained the distribution of goals, as FAA traffic managers did not have to directly consider airline business concerns in approving requests for nonpreferred routes. They just had to evaluate the flights plans submitted by the airlines in terms of their impact on safety and system utilization. Similarly, airline dispatchers did not have to consider the impact of alternative routes for a flight on overall system utilization or on air traffic congestion; they just had to evaluate the routes in terms of safety and cost-effectiveness for their company. Hence, it provided a means for limiting the complexity of the decision-making task for any one individual (a traffic manager or a dispatcher), but provided a means for arriving at closer to optimal solutions.

The available data suggested that such a paradigm shift did indeed produce more cost-effective performance without any indication that safety was being compromised (McCoy, Smith, and Orasanu et al., 1995; Smith, McCoy, and Orasanu et al., 1996a). There were, however, two concerns expressed regarding the ultimate effectiveness of this approach:

1. Such interactions to get permission to fly non-preferred routes were costly in terms of the staffing requirements for both AOCs and the FAA
2. Continuing to give FAA traffic managers responsibility for evaluating airline requests provided insufficient impetus to explore the feasibility of new routings (as the traffic managers and controllers involved could achieve the goals for which they were primarily responsible — safe and efficient overall use of system capacity — without significantly changing the status quo).

As a result, a new order was implemented, referred to as the expanded NRP (Federal Aviation Administration, 1995), which gave the airlines greater autonomy (Denning et al., 1996). Under the expanded NRP, subject to certain constraints, the airlines were allowed to file flight plans (preflight) without seeking permission from ATCSCC (Carlson, Rhodes, and Cullen, 1996). This new paradigm was an example of “control by exception” (Sheridan, 1987, 1992), in the sense that, under its rules, the ATC system was supposed to intervene only after a flight had been launched, taking corrective actions to deal with traffic bottlenecks tactically, rather than preflight. (Under some circumstances, such as the development of a broad area of bad weather, traffic managers could still revert back to “control by directive” by canceling the NRP.) The available data indicate that this further paradigm shift has resulted in additional efficiencies for the airlines (Corlouris and Dorsky, 1995; Smith, McCoy, Orasanu et al., 1996b).

Distributing Information and Knowledge to Support Decision-Making

Although such paradigm shifts in the locus of control appear to have produced efficiencies, the available data indicate that, to maximize gains from such paradigm shifts, there is a need for improvements in access to information and knowledge, and for tools to help decision-makers cope with the added complexities that such shifts in control introduce. Indeed, after experience with this “control by exception” paradigm, dispatchers made such comments as “under the expanded NRP, it’s like shooting ducks in the dark,” and “it used to be the weather that was the biggest source of uncertainty. Now it’s the air traffic system” (Smith, McCoy, Orasanu et al., 1996b).

Empirical studies indicate that such a lack of information about air traffic bottlenecks can result in fuel losses instead of fuel gains when flights filed under the expanded NRP along fuel efficient routes are rerouted by the ATC system to avoid excessive traffic congestion. As an example of a worst case scenario, Smith, McCoy, and Orasanu et al. (1996b) found that flights scheduled to fly NRP routes from Los Angeles to Dallas, and to arrive during the noon rush, on average burned 1.9% more fuel than they would have if filed on the FAA preferred route, instead of achieving the 4.5% fuel savings expected from the NRP route.

The implication of such studies is that, if the locus of control is shifted without a concomitant shift in access to information and knowledge (in this case dealing with ATC responses to air traffic bottlenecks), benefits may be less than expected.

Developing Alternative Models of Cooperative Problem-Solving to Cope with Complexity

The “control by permission” model described earlier represented a model for cooperative problem-solving that reduced complexity for any one individual (traffic manager or dispatcher) by continuing to distribute responsibility for certain goals between AOCs and traffic managers. The “control by exception” paradigm potentially reintroduces this complexity for the dispatcher, as, potentially, he or she is now expected to integrate a much broader set of factors in order to develop “optimal” plans to meet the needs of an airline’s schedule. (As discussed earlier, traffic managers still serve as a safety net to identify and prevent situations where traffic flows could impact safety or overall efficiency in the use of system capacity, and do this by reverting back to a “control by directive” paradigm.)

A number of approaches are being explored to deal with this (Adams et al., 1996; Billings, 1997; McCoy et al., 1991; Pujet and Feron, 1996; RTCA, 1995; Smith, McCoy, Orasanu et al., 1996c). Some of them focus on enhancing data exchange and collaboration between AOCs and traffic managers, including the use of “white-boards” to enhance interactions and provide a framework for developing shared mental models and for sharing knowledge (McCoy, Orasanu et al., 1995; Orasanu, 1991). Others focus on distributing responsibilities within AOCs, essentially changing the organizational structures to reduce the complexity for any one individual. Still others are exploring the use of decision-support systems to reduce the workload and complexity for individuals. Finally, some proposals focus on reformulating the problem by changing the parameters of control. Under these proposals, instead of having the FAA impose detailed solutions, such as implementing an “all Centers” ground stop, the FAA would instead place a constraint on airline generated solutions, such as “each airline must reduce its arrival rate at a particular airport by 50%.”

Ergonomic Issues in TFM — Summary

As outlined above, at a macroscopic level, the critical question regarding the design of the TFM system has been identifying the truly important determinants of performance. In recent years, a number of approaches for revising the design of the system have been discussed. Some of these, such as shifts in the underlying paradigm of control from “control by directive” to “control by permission” to “control by exception,” have actually been implemented for some aspects of the TFM system. Others, such as changing the parameters for controlling airline performance, have thus far only been proposed. To understand the impact of such factors, a number of observational studies have been conducted. These studies indicate that such changes can in fact have a significant impact on performance, but because of the inherent confoundings in such studies, they do not definitively establish the relative contributions of the different changes that have been made to the system.

Thus, the fundamental human factors question remains: in an environment where capacity is limited and where there are competing goals (among the airlines), how do we design a system where the cognitive demands on individuals are reasonable, and yet still achieve high levels of performance?

34.5 Issues in the Design of the Future ATM System

Recently, the FAA and the aviation industry reached general consensus on a strategic direction for the ATM system in the United States called “free flight” (RTCA, 1995). The goal of free flight is an ATM system based on two fundamental premises:

1. The FAA retains and strengthens its safety mandate for separation of aircraft
2. The users of the system are given the flexibility to make decisions that allow them to extract the maximum economic benefit from the ATM system

Among other characteristics, free flight assumes a shift way from the current ground-based, tactical ATC operations toward a more cooperative arrangement in which users have greater flexibility to select and manage their flight paths and to participate routinely in airspace management decisions. As the ATM system evolves toward free flight, consideration of the human element will be critical to the realization

of new operating philosophies, design of new functional architectures for integrating ATM system components, and application of advanced technologies to support ATM operations.

New Philosophies and Procedures

TFM

Under free flight, the fundamental goal for future TFM is to identify new operating philosophies and procedures that remove restrictions, allowing users to make choices based on business considerations subject to the constraints necessary to ensure safety.

Historically, TFM decision-making has been characterized by gaming, in which the users, armed with limited information about the state of the system and the rationale for denying or approving requests, attempt to achieve an advantage over their competitors and “the system” by hiding their true intentions and preferences. This gaming has led to mistrust and suspicion among the participants. In the future, a team perspective is likely to provide important insight into many of the issues in TFM. The team literature addresses the functional requirements for interpersonal collaboration as well as the social dynamics (Fleishman and Zaccaro, 1992; Scerbo, 1996). With regard to team functions, human factors knowledge and research can contribute to the definition of processes which meet system needs for acquiring and distributing information, coordinating the sequence and timing of participants’ responses, evaluating team performance, establishing team objectives and means to resolve disputes, and monitoring for compliance with policies. With regard to social dynamics, a progressive research approach is needed to accumulate experience in real-world settings that will allow participants to practice team performance and assess the effectiveness and reliability of the collaborative process. Real-world experience will also help refine the decision-making process and reduce decision-maker biases and mistrust among the participants.

ATC

Currently in ATC, the basic rule of separation is that every controller is responsible for separation of participating aircraft for the duration of time the aircraft is within the controller’s sector of responsibility (Nolan, 1990). In future ATC, the free flight goal is to evolve toward a more strategic operation that better accommodates user preferences. Under this philosophy, controllers may assume more responsibility for solving each other’s problems as strategic predictions allow for early ATC interventions. In addition, as new technologies provide pilots with information and capabilities commensurate with or surpassing those of the controller, they may also be called upon to participate in solving ATC problems.

As in TFM, a team perspective is likely to be a major focus in addressing human factors issues in future ATC. Considerable research and analysis has addressed the controller’s role (often as a single operator) within an ATC domain. There is much less work that addresses the multi-operator perspective (Benel, 1995). Wickens, Mavor, and McGee (1997) also note that team training is less formal in ATC than on the flight deck, but teamwork is likely to be a critical component of ATC for the foreseeable future. Drawing on the literature in team performance will help identify functional requirements for collaboration in ATC. In the initial stages of orientation and trust building, laboratory and field evaluations can be used to work out task redesigns, clarify goals and roles, and establish commitment. To sustain team performance, the collaborative philosophy of ATC will need to be clearly communicated to the controller workforce and reinforced through training, experience, and feedback programs that address concerns.

Functional Architecture

Already, new ATM technologies such as CTAS cut across traditional divisions of responsibility between en route and TRACON controllers, while strategic planning tools such as conflict probe tend to blur the distinction between ATC and traffic management responsibilities. It is also likely that workload concentrations in the tower environment will motivate further reallocation of tasks across ATC environments and additional capabilities for smoothing workload through greater human control over the tasks, their timescales, their scheduling, and their sequencing (Laios and Giannacourou, 1995). At the same time,

imbalances in air and ground system capabilities in the oceanic environment will motivate exploration of alternative allocations of functions between controllers and pilots which increase the pilot's role in ATC. These forces, taken together with the new operating philosophies envisioned under free flight, will drive a progression toward new relationships among system participants.

Analyses of human factors issues in free flight identified the design of a new functional architecture as a key issue that cuts across all environments (Federal Aviation Administration, 1995). In TFM, human factors can help analyze the roles and interactions of TFM players, including central and local traffic managers and the AOC personnel. For example, laboratory simulations can resolve issues regarding human cognitive capacities and performance parameters, such as how much and how fast information can be assimilated. These results on the timing and quality of feedback needed by decision makers will help discriminate among alternative allocations of functions and define the interrelationships among groups of decision makers. In ATC, human factors can help evaluate the allocation of responsibility between controllers and pilots in all of the operational environments. And within the ATM organization, human factors can help analyze and evaluate the allocation of responsibility between controller team members and between controllers and traffic managers. For example, laboratory simulations can be used to explore the feasibility and effectiveness of new roles, such as a planner/coordinator controller role that uses automated tools to support multiple sector controllers. Such a role might combine functions currently performed by a D controller, supervisor, and traffic manager.

Advanced Technologies

At present, the technologies needed to support collaborative TFM are still in conceptual stages. Commercial off-the-shelf technologies and prototypes exist for facilitating meetings between participants at remote locations, but their application to real-time operational environments such as TFM will take some exploration (Roberts, Zobell, and Blanchard, 1993). At this stage, human factors can assist in development of advanced technology that is designed with the express purpose of supporting teams. For example, research has shown that process behaviors tend to degrade under conditions of high workload. Automating team processes themselves may allow teams to perform more effectively (Bowers et al., 1996). In addition, distributed decision-making may require multiple modes of information transfer (e.g., text, graphics, and voice) to ensure successful communication (Scerbo, 1996).

In ATC, U.S. research and development on the next step in the evolution of ATC automation is aimed at automated advisories for final approach spacing and conflict resolution. This level of automation will have a profound impact on the way ATC is performed. Not surprisingly, there is considerable concern in the human factors community over the impact of such automation on the controller's situation awareness and ability to provide back-up for the automation system when necessary. An alternative approach is being pursued in Europe which focuses more on highly interactive problem-solving tools, including display formats that enable the controller to plan more efficient strategies (Makins and Drew, 1995). In the current environments, the en route and TRACON controllers' displays are optimized for vector solutions to separation and spacing problems (Kerns, 1994). Alternative formats, such as graphical displays of the temporal distribution of problems and predictive displays depicting a vertical view of the traffic situation, may facilitate situation awareness and strategy planning.

It is likely that both the U.S. and European approaches have application in the operational environment. Before questions on human roles can be addressed, more fundamental questions must be answered regarding the efficiency of the alternatives in different task environments and the nature of the back-up mechanisms. Laboratory simulations can help answer questions regarding the efficiency of controller tools under various traffic scenarios. Requirements for maintaining situation awareness and controller skills will vary according to the need for manual back-up in the future environment (Wickens, Mavor, and McGee, 1997). Human factors analyses can help specify these requirements under various back-up mechanisms.

34.6 Conclusion

There are major challenges ahead in analyzing functional requirements and the allocation of functions between human and automated elements of the future ATM system. At this point, there is an opportunity for proactive research in human factors to gain insight and perspective on issues surrounding collaborative ATM. Multiple research approaches, including the review and application of existing data and knowledge, will make it possible to prove the value of new concepts regarding human roles and interrelationships and their impact on the quality and efficiency of the ATM system. As the discussion above indicates, however, this is a system that has historically attempted to match the capabilities of the people with the demands of the system by distributing roles and responsibilities, and by imposing structure. Efforts to enhance efficiency through increased flexibility and shifts in the locus of control need to be based on an understanding of the complexity inherent in this system, and on a realistic assessment of the strengths and limitations of the technologies being considered to support controllers, pilots, traffic managers, and dispatchers in their new roles.

Defining Terms

AOC: Airline Operations Center
ARTCC: Air Route Traffic Control Center
ATC: Air Traffic Control
ATCSCC: Air Traffic Control Systems Command Center
ATIS: Automated Terminal Information Service
ATM: Air Traffic Management
CRDA: Converging Runway Display Aid
CTAS: Center TRACON Automation System
FAA: Federal Aviation Administration
FAST: Final Approach Spacing Tool
PDC: Predeparture Clearance
TFM: Traffic Flow Management
TRACON: Terminal Radar-Approach Control Facility

Acknowledgment

Portions of this chapter are based on research supported by the FAA Office of the Chief Scientist and Technical Advisor for Human Factors, the MITRE Corporation Center for Advanced Aviation System Development, and by the NASA Ames Research Center.

References

- Adam, G.A., Kelley, D.R., and Steinbacher, J.G. 1994. *Reports by Pilots on Airport Surface Operations: Part 1. Identified Problems and Proposed Solutions for Surface Navigation and Communications*. The MITRE Corporation MTR94W60.V1.
- Adam, G.A. and Kelley, D.R. 1996. *Reports by Pilots on Airport Surface Operations: Part 2. Identified Problems and Proposed Solutions for Surface Operational Procedures and Factors Affecting Pilot Performance*. The MITRE Corporation MTR94W60.V2.
- Adams, M., Koltitz, S., and Odoni, A. 1996. Evolutionary concepts for decentralized air traffic flow management. *Proceedings of the 1996 AIAA Guidance Navigation and Control Conference*. San Diego, CA, 1-11.
- Airline Dispatchers Federation and Seagull Technology, Inc. 1995. *Airline Operational Control Overview*. Cooperative Research and Development Agreement 93-CRDA-0034, Washington, D.C.

- Andrews, J. 1993. Impact of weather event uncertainty upon an optimum ground-holding strategy. *ATC Quarterly*, 1: 59-84.
- Bales, R.A., Gilligan, M.R., and King, S.G., 1989. An Analysis of ATC-Related Runway Incursions with Some Potential Technological Solutions, MTR-89W21, The MITRE Corporation, McLean, VA.
- Benel, R. 1995. The human role in aircraft-air traffic automation integration: what we don't know can't help us, in *Human Factors in Aviation Operations: Proceedings of the 21st Conference of the European Association for Aviation Psychology*, Eds. Fuller, R., Johnston, N., and McDonald, N. p. 102-108.
- Bellorini, A. and Decortis, F. 1995. A stress-based analysis in Air Traffic Control, in *Human Factors in Aviation Operations: Proceedings of the 21st Conference of the European Association for Aviation Psychology*, Eds. Fuller, R., Johnston, N., and McDonald, N. p. 95-102.
- Billings, C. 1997. *Aviation Automation: The Search for a Human-Centered Approach*. Lawrence Erlbaum Associates: Mahwah, NJ.
- Bowers, C., Oser, R.L., Salas, E., and Cannon-Bowers, J.A. 1996. Team performance in automated systems, in *Automation and Human Performance: Theory and Applications*, Eds. Parasuraman, R. and Mouloua, M. p. 243-266. Lawrence Erlbaum Associates: Mahwah, NJ.
- Bruce, D.S. 1996. *Physical Performance Criteria for Air Traffic Control Tower Specialists*. Washington, D.C.: U.S. Department of Transportation, Federal Aviation Administration.
- Burki-Cohen, J. 1995. *An Analysis of Tower Controller-Pilot Voice Communications* (DOT/FAA/AR-96/19) Washington, D.C.: U.S. Department of Transportation, Federal Aviation Administration.
- Canadian Aviation Safety Board, 1990, Report on a Special Investigation into Air Traffic Control Services in Canada, No. 90-SO001. *Supply and Services Canada Catalog No. TU4-5/1990E*.
- Cardosi, K. 1993. *An Analysis of En Route Controller-Pilot Voice Communications* (DOT/FAA/RD-93/11) Washington, D.C.: U.S. Department of Transportation, Federal Aviation Administration.
- Cardosi, K., Brett, B., and Han, S. 1996. *An Analysis of TRACON Controller-Pilot Voice Communications* (DOT/FAA/AR-96/66) Washington, D.C.: U.S. Department of Transportation, Federal Aviation Administration.
- Carlson, L., Rhodes, L., and Cullen, M. 1996. *Effects of Unstructured Routes on En Route Controllers' Work Activities and Operational Environment*, MITRE Technical Report MTR 96W0000019, Mclean VA.
- Coulouris, G. 1985, *Study of U.S. Oceanic Airtraffic Control Consolidation and Automation* DOT/FAA/ES-85-5, U.S. Department of Transportation, Federal Aviation Administration, Washington, D.C.
- Coulouris, G. and Dorsky, S. 1995. *Advanced Air Transportation Technologies (AATT) Potential Benefits Analysis*. Cupertino CA: Seagull Technology.
- Credeur, L., Capron, W.R., Lohr, G.W., Crawford, D.J., Tang, D.A., and Rodgers, W.G. 1993. A comparison of final approach spacing aids for terminal ATC automation, *Air Traffic Control Quarterly*, 1(2):135-177.
- Davis, R. and Smith, R. 1983. Negotiation as a metaphor for distributed problem-solving. *Artificial Intelligence*, 20: 63-109.
- Davis, T.J., Erzberger, H., Green, S.M., and Nedell, W. 1991. Design and Evaluation of an air traffic control final approach spacing tool. *Journal of Guidance Control and Dynamics*. 14: 848-854.
- Denning, R., Smith, P.J., McCoy, E., Orasanu, J., Billings, C., Van Horn, A. and Rodvold, M. 1996. Initial experiences with the expanded national route program. *Proceedings of the 1996 Annual Conference of the Human Factors and Ergonomics Society*. Philadelphia: Sept. 2-6, 98-101.
- Federal Aviation Administration 1992. *Concept of Operations: A Description of the Baseline Oceanic ATC System*. Air Traffic Plans and Requirements Service Department of Transportation Federal Aviation Administration Washington, D.C. DOT/FAA/AT-93-2
- Federal Aviation Administration 1991. *Precision Runway Monitor Demonstration Report* (DOT/FAA/RD-91/5) Washington, D.C.: U.S. Department of Transportation, Federal Aviation Administration.
- Federal Aviation Administration 1992. *National Route Program*, Advisory Circular 90-91, ATM 100, April 24, 1992.
- Federal Aviation Administration 1995. *Advancing Free Flight Through Human Factors: Workshop Report*. U.S. Department of Transportation, Federal Aviation Administration: Washington, D.C.

- Federal Aviation Administration 1995. *National Route Program (NRP)*, FAA Order 7110.128, Free Flight, ATM 100, effective Jan. 9, 1995.
- Fleishman, E.A. and Zaccaro, S.J. 1992. Toward a taxonomy of team performance functions, in *Teams: Their Training and Performance*, Eds. Swezey, R.W. and Salas, E. p. 31-56: Ablex: Norwood, NJ.
- Galushka, J., Frederick, J., Mogford, R., and Crois, P. 1995. *Plan View Display Baseline Research Report*. (DOT/FAA/CT-TN95/45) Washington, D.C.: U.S. Department of Transportation, Federal Aviation Administration.
- Garland, D., Hopkin, V.D., and Muller, J. 1996. *The Air Traffic Control System Command Center's Operational Workplace: Volume II — Human Factors Recommendations*. Daytona Beach, FL: Embry-Riddle Aeronautical University.
- Grayson, R.L. and Billings, C.E. 1981. Information transfer between air traffic control and aircraft: Communication problems in flight operations, in *Information Transfer Problems in the Aviation System* (NASA Technical Paper 1875), Eds. Billings, C.E. and Cheaney, E.S. Moffett Field, CA: NASA Ames Research Center.
- Hamrick, L.Y. and Reiersen, J.D., 1993, Operational Concept for the Enhanced Oceanic Conflict Probe, MTR93W67, The MITRE Corporation, McLean, VA.
- Hopkin, V.D. 1988. Air traffic control, in *Human Factors in Aviation*, Eds. Weiner, E.L. and Nagel, D.C. p. 639-662. Academic Press, San Diego.
- Hopkin, V.D. and Wise, J.A. 1996. Human factors in air traffic system automation, in *Automation and Human Performance: Theory and Applications*, Eds. Parasuraman, R. and Mouloua, M. p. 319-336. Lawrence Erlbaum Associates: Mahwah, NJ.
- Kerns, K. 1991. Data link communication between controllers and pilots: a review of the simulation literature. *The International Journal of Aviation Psychology*, 1(3): 181-204.
- Kerns, K. 1994. *Human Factors in ATC/Flight Deck Integration: Implications of Data Link Simulation Research* MP94W98 The MITRE Corporation, McLean, VA.
- Kinney, G.C. 1977. *The Human Element in Air Traffic Control: Observations and Analyses of the Performance of Controllers and Supervisors in Providing ATC Separation Services*, MITRE Technical Report MTR 7655. The MITRE Corporation: McLean, VA.
- Kinney, G.C., Bell, G.L., and Ditmore, M.A., 1983, *The Human Element in Air Traffic Control: Factors in System Recovery and Revitalization*, MTR-82W151, The MITRE Corporation, McLean, VA. (not in Public Domain).
- Klein, G. 1992. *The Human Air Traffic Management Role in a Highly Automated Air Traffic System*. MITRE Technical Report # ARDATMR-MTR-92W0000075, McLean, VA.
- Lacher, A. and Klein, G. 1993. *Air Carrier Operations and Collaborative Decision-Making Study*, MTR 93W0000244, The MITRE Corporation, Mclean VA.
- Laios, L. and Giannacourou, M. 1995. Human factors issues of advanced ATC systems, in *Human Factors in Aviation Operations: Proceedings of the 21st Conference of the European Association for Aviation Psychology*, Eds. Fuller, R., Johnston, N., and McDonald, N., p. 108-113. Ashgate Publishing Limited: Cambridge, England.
- Layton, C., Smith, P. J., and McCoy, E. 1994. Design of a cooperative problem-solving system for en route flight planning: An empirical evaluation. *Human Factors*, 36: 94-119.
- Lee, K. K. and Davis, T.J. 1995. The development of the final approach spacing tool (FAST): A cooperative controller-engineer design approach. *Proceedings of the International Federation of Automatic Control Conference: Automated Systems Based on Human Skill*, Berlin, Germany. 219-226.
- Lee, K.K., Pawlak, W.S., Sanford, B.D., and Slattery, R.A. 1995. Improved navigation technology and air traffic control: A description of controller coordination and workload, in *Proceedings of the Eighth International Symposium on Aviation Psychology*, Columbus, OH. 444-449.
- Leroux, M. 1995. ERATO: cognitive engineering applied to ATC, in *Human Factors in Aviation Operations Proceedings of the 21st Conference of the European Association for Aviation Psychology*, Eds. Fuller, R., Johnston, N., and McDonald, N. 89-94.

- Makins, N. and Drew, A. 1995. *Integrating FMS Data Into Air Traffic Control: A Prototyping Exercise Exploring the Operational Consequences and Possible Effects on Controller Roles*. EC Note No. 28/95 EUROCONTROL Experimental Center, Bretigny-sur-Orge, France.
- McAlindon, P.J. and Gupta, U.G. 1993. A structured approach to the verification and validation of expert systems, in *Verification and Validation of Complex Systems: Additional Human Factors Issues*, Eds. Wise, J.A., Hopkin, V.D., and Stager, P., 15-23. Embry-Riddle Aeronautical University Press: Daytona Beach FL.
- McCoy, E., Orasanu, J., Smith, P. J., VanHorn, A., Billings, C., Denning, R., Rodvold, M., and Gee, T. 1995. Situational awareness at different levels of abstraction: Distributed cooperative problem-solving in ATCSCC-airline interactions. *Proceedings of the International Conference on Experimental Analysis and Measurement of Situation Awareness*. Daytona Beach, FL, Nov. 1-3.
- McCoy, C. E., Smith, P. J., and Layton, C. 1991. Research in cooperative problem-solving systems for aviation. *Proceedings of the 1991 Aviation Psychology Symposium*, Columbus, OH, 894-903.
- McCoy, C. E., Smith, P. J., Orasanu, J., Billings, C., VanHorn, A., Denning, R., Rodvold, M., and Gee, T. 1995. Airline dispatch and ATCSCC: A cooperative problem-solving success story with a future. *Proceedings of the 1995 Aviation Psychology Conference*, Columbus, OH, 456-460.
- Morrow, D., Lee, A., and Rodvold, M. 1993. Analysis of problems in routine controller-pilot communications. *The International Journal of Aviation Psychology*, 3(4): 285-302.
- Mundra, A.D. 1989, A Description of Air Traffic Control in the Current Terminal Airspace Environment, MTR88W167, The MITRE Corporation, McLean, VA.
- Mundra, A. D. and Levin, K. M. 1990. *Developing Automation for Terminal Air Traffic Control: Case Study of the Imaging Aid*. MP90W29, The MITRE Corporation, McLean, VA.
- Nolan, M. 1990. *Fundamentals of Air Traffic Control*. Belmont, CA: Wadsworth.
- Norman, D.A. and Bobrow, D.G. 1975. On data limited and resource limited processes. *Cognitive Psychology*, 7: 44-64.
- Odoni, A.R. 1987. The flow management problem in air traffic control, in *Flow Control of Congested Networks*, Eds. Odoni, A.R., Bianco, L., and Szego, G. Springer-Verlag: Berlin.
- Orasanu, J. 1991. Shared problem models and flight crew performance, in *Aviation Psychology in Practice*, Eds. Johnston, N., McDonald, N., and Fuller, R. Avebury: Brookfield, VT., 255-285.
- Pujet, N. and Feron, E. 1996. Flight plan optimization in flexible air traffic environments. *Proceedings of the 1996 AIAA Guidance Navigation and Control Conference*. San Diego, CA, 1-10.
- Roberts, G. 1993. *Visual Collaboration in Air Traffic Control*. (MTR-W0000247). The MITRE Corporation: McLean, VA.
- Roberts, G., Zobell, S. and Blanchard, J., 1993, *Visual Collaboration in Air Traffic Control*, MITRE Technical Report MTR-W000247, The MITRE Corporation, McLean, VA. (Not in Public Domain.)
- Rodgers, M.D. 1993, An Analysis of the Operational Error Database for Air Route Traffic Control Centers, DOT/FAA/AM, Federal Aviation Administration, Washington, D.C.
- RTCA 1995. *Final Report of RTCA Task Force 3: Free Flight Implementation*. RTCA Incorporated, Washington, D.C.
- RTCA 1995. *Report of the RTCA Board of Directors' Select Committee on Free Flight*. RTCA Incorporated, Washington, D.C.
- Sarter, N.B. 1996. Cockpit automation: from quantity and quality, from individual pilot to multiple agents, in *Automation and Human Performance: Theory and Applications*, Eds. Parasuraman, R. and Mouloua, M. p. 267-280. Lawrence Erlbaum Associates: Mahwah, NJ.
- Scardina, J., Simpson, T., and Ball, M. 1996. ATM: The only constant is change. *Aerospace America*, March, 20-40.
- Scerbo, M.W. 1996. Theoretical perspective on adaptive automation, in *Automation and Human Performance: Theory and Applications*, Eds. Parasuraman, R. and Mouloua, M. p. 37-64. Lawrence Erlbaum Associates: Mahwah, NJ.
- Schultheis, S. and Tucker, M. 1996. *User Request Evaluation Tool (URET) Evaluation Report*, MTR96W64, The MITRE Corporation, McLean, VA.

- Sheridan, T. 1987. Supervisory control, in *Handbook of Human Factors*, Ed. G. Salvendy. Wiley: New York.
- Sheridan, T. 1992. *Telerobotics, Automation and Human Supervisory Control*. Cambridge, MA: MIT Press.
- Shingledecker, C.A. and Darby, E.R. 1995. Effects of data link ATC communications on controller teamwork and sector productivity. *The Air Traffic Control Quarterly*, 3(2), 65-94.
- Smith, P.J., McCoy, C.E., Orasanu, J., Billings, C., Denning, R., Rodvold, M., Gee, T., and Van Horn, A. 1996a. Control by permission: a case study of cooperative problem-solving in the interactions of airline dispatchers with ATCSCC, *Air Traffic Control Quarterly*, 4(4): 229-247.
- Smith, P.J., McCoy, E., Orasanu, J., Denning, R., Billings, C., Owlsey, T., Boeve, E., Bullington, R., and France, E. 1996b. *An Empirical Study of the Expanded National Route Program on Flight Planning and Performance*. Cognitive Systems Engineering Laboratory, Technical Report # 1996-18, The Ohio State University, Columbus OH and Ohio University, Athens OH.
- Smith, P. J., McCoy, E., Orasanu, J., Billings, C., Denning, R., Rodvold, M., Van Horn, A., and Gee, T. 1996c. Cooperative problem-solving in the interactions of airline dispatchers with the Air Traffic Control Systems Command Center, in *Human Interaction with Complex Systems: Conceptual Principles and Design Practice*, Eds. Ntuen, C. and Park, E., p. 185-195. Kluwer Academic Publishers: Boston, MA.
- Sperandio, J.C. 1971. Variation of Operator's strategies and regulating effects on workload. *Ergonomics*, 14: 571-577.
- Sperandio, J.C. 1978. The regulation of working methods as a function of workload among air traffic controllers. *Ergonomics*, 21:195-202.
- Wambsganss, M. 1995. *Collaborative Traffic Flow Management*. Metron: Washington, D.C.
- Whitfield, D. 1979. A preliminary study of the air traffic controller's "Picture." *CATCA Journal*, Spring, 19-28.
- Wickens, C., Mavor, A., and McGee, J. 1997. *Flight to the Future: Human Factors in Air Traffic Control*. National Academy Press: Washington, D.C.
- Wiener, E. and Nagel, D., 1988 *Human Factors in Aviation*. Academic Press: San Diego, CA.

Indexes

A

Absenteeism, 6-15, 6-17, 32-4
costs, 6-8
data, 12-21
decreased, 9-16
miner, 29-2
reduction of, 12-3
stressful jobs and, 13-12

Absolute critical boundary, definition of, 20-14

Acceleration
definition of, 17-1
expression of, 17-2

Accelerometer, 17-5

Accident
investigation, 13-12
Prevention Rules, 22-14

Accounting records, 8-7

Acoustical calibrator, 16-17

Acoustical engineer, 16-31

Acoustical measurements, application of decibel scale to, 16-3

Acoustic trauma, 16-9

Acquisition costs, 6-7

Active noise reduction (ANR), 16-29

Actuarial analysis, 19-4

Acute exposure
hazard analysis, 19-11
schedule change, 19-11

ADA, *see* Americans with Disabilities Act

Administrative changes, 13-15

AEEB, *see* Automated Ergonomics Evidence Book

Affective domain, taxonomy of learning outcomes in, 15-6

Agile Manufacturing, 24-1

Agile manufacturing, human factors in, 27-1 to 14
communications, 27-5
differences between agile and traditional enterprises, 27-5 to 10
ergonomics of agile shop floor, 27-10 to 12
product data management, 27-3 to 4
product specification and automated design, 27-2 to 3
virtual prototype testing, 27-4
visualization, 27-5

AHS, *see* Automated highway system

Airline
operation centers (AOCs), 34-4
reservation desk, 20-4

Air route traffic control centers (ARTCCs), 34-2

Air traffic control (ATC), 34-1, 34-9, 34-10

Air traffic management (ATM), 34-1 to 25
defining terms, 34-21
human factors in air traffic control, 34-4 to 14
human factors in traffic flow management, 34-14 to 18
issues in design of future ATM system, 34-18 to 20
system overview, 34-2 to 4

Alertness, circadian variations in, 19-6

Alternative projects, internal rate of return for comparing, 8-12

American National Standard for Human Factors Engineering
of Video Display Workstations, 20-7

American National Standards Institute (ANSI), 13-4
standards, 16-8
Working group S12/WG11, 16-27

Americans with Disabilities Act (ADA), 13-5

ANR, *see* Active noise reduction

ANSI, *see* American National Standards Institute

AOCs, *see* Airline operation centers

Apple Computer Inc., 5-7

Armrests, 20-8, 21-8

ARTCCs, *see* Air route traffic control centers

Assembly operation, 8-2

Assumptions, 1-3, 3-9

ATC, *see* Air traffic control

ATIS, *see* Automatic terminal Information Service

ATM, *see* Air traffic management

Audio-dosimeter, 16-15

Audiometric database analysis, 16-28

Audiometric testing program, 16-25

Audits, 13-12
external, 30-4
internal, 30-4
spot-, 12-27

Automated Ergonomics Evidence Book (AEEB), 12-27

Automated highway system (AHS), 8-26
capacity, 8-28
configuration, feasible, 8-28
design speed, 8-28
-outfitted vehicles, 8-27

Automatic terminal Information Service (ATIS), 34-6

Automation, product design for, 26-2

Awareness training, 12-13, 13-10

B

Back injury reduction program, 5-6

Backward Kansei Engineering, 25-6

Barriers
knowledge-based, 12-6
organizational-based, 12-6
typical, 10-6

B/C, *see* Benefit/Cost ratio

Behavior(s)
assumption about, 3-9
modification, 3-9
unsafe, 3-9

Behavioral changes, 3-8 to 12
feedback, 3-10 to 11
follow-up, 3-11 to 12
measure baseline, 3-10
performance measurement, 3-9 to 10
theoretical background, 3-8 to 9

Benchmarking, 1-2, 5-2, 19-4

Benefit/Cost
analysis, 5-9
ratio (B/C), 6-11

Biomechanical efficiency, 20-4

Biomechanical modeling, 29-9

Black globe temperature, 18-8

Body
part discomfort surveys, 32-4
systems, 4-7

Boothroyd's principles, product design for automation using, 26-2

Bureau of Labor Statistics (BLS), 13-11

- Business
 - corporation, 7-1
 - function, establishment of ergonomics as, 11-1
 - metric, money as, 6-2
 - objectives, 10-2
 - Process Improvement, 4-1
 - Reengineering, 4-1, 24-1
- Bygghälsan, 11-2
- C**
- CAD model, 27-4
- Calculations
 - flawed, 8-3
 - present worth, 8-29
- CAM, *see* Computer-Aided Manufacturing
- CAOHC, *see* Council of Accreditation in Occupational Hearing Conservation
- Capital expenditures, 6-1, 6-11, 6-17
- Carpal tunnel
 - case, post-injury ergonomics intervention for a chronic, 9-17
 - surgery case, 7-4
 - syndrome (CTS), 15-1
- Cash flow(s)
 - diagram, 6-17, 6-18
 - repeated, 8-10
- Catalogue pages, 30-22, 30-24
- CBR, *see* Cost benefit ratio
- CEG, *see* Corporate Ergonomic Group
- CEG Ergonomics Colloquium, 5-6
- Certified Nurse's Aide (CNA), 9-15
- CET, *see* Corrected effective temperature
- Chairs, *see* Seating and chairs
- Change(s)
 - administrative, 13-15
 - engineering, 13-15
 - ergonomic, technology-driven, 32-1
 - make-it-work, costs associated with, 4-7
 - management, 4-3, 10-8
 - principles, 1-3
 - resistance to, 11-5
 - strategies, 3-14
- Chart of consequences, 30-25
- Choice reaction time, 26-9
- Chronic exposure, 19-11
- Chronobiology, 19-3
- Claim cost, measurement of, 9-4
- CNA, *see* Certified Nurse's Aide
- CNC-workstations, 24-5
- Communication(s)
 - breakdowns, 12-23
 - characteristics, ergonomics program, 12-25
 - controller-pilot, 34-12
 - electronic speech, 16-9
 - presence, 2-7, 2-8
- Communicator Crystal Award, 5-12
- Competency level, minimum, 8-29
- Competition, global, 1-1
- Competitive benchmarking, 1-2
- Component Display Theory, 15-5
- Computer(s)
 - Aided Manufacturing (CAM), 27-5
 - programming, offshore, 1-1
 - use of to overcome challenges, 12-26
 - work, psychosocial factors and musculoskeletal disorders in, 23-1 to 7
- Concurrent Engineering, 4-1
- Conduction, heat transmission by, 18-3
- Construction industry, 33-1 to 11
 - ergonomic risk factors in, 33-6
 - exposure assessment for ergonomic risk factors in construction, 33-2 to 3
 - introduction and implementation of interventions in construction, 33-7
 - regulatory standards, 33-7 to 8
 - research on ergonomic problems in, 33-3
 - risk factors associated with different trades, 33-2
 - size and scope of problem, 33-1
 - types of interventions in construction, 33-4 to 7
 - using surveillance data to identify high-risk trades, 33-1 to 2
- Consulting, 5-6
- Continuous improvement, 4-2, 4-3
- Continuous models, estimating parameter r in, 8-9
- Control by exception paradigm, 34-18
- Controller-pilot communications, 34-12
- Control by permission
 - model, 34-18
 - paradigm, 34-17
- Corporate cost avoidance using sound ergonomics technology
 - and quality-based customer services, 5-1 to 14
 - accomplishments and performance metrics, 5-7 to 11
 - community outreach, 5-13
 - Corporate Ergonomics Group, 5-2 to 3
 - project plan, 5-1 to 2
 - quality approach, 5-2
 - quality metrics and awards, 5-11 to 12
 - services developed, 5-3 to 7
- Corporate culture, influence of on cost benefit analysis, 9-10
- Corporate Ergonomic Group (CEG), 5-2, 5-4
- Corporate management duties, 7-2
- Corporate values, documented statements communicating, 9-11
- Corrected effective temperature (CET), 18-9
- Cost(s)
 - absenteeism, 6-8
 - acquisition, 6-7
 - benefit ratio (CBR), 9-14
 - benefit variables, summary of potential, 9-13
 - claim, measurement of, 9-4
 - deterioration, 8-6
 - development, 6-7
 - direct claim, 9-3
 - driver analysis, 9-12
 - employee severance, 6-7
 - ergonomic mismatch, 9-3
 - ergonomic solutions, 10-5
 - hiring, 7-9
 - holding, 8-15
 - indirect claim, 9-3
 - injury, 7-6
 - intervention, 12-17, 12-22
 - inventory, 8-15, 8-16, 8-21
 - justification methods, 7-3 to 6
 - light duty assignment, 6-13
 - one-time, 6-10, 6-17
 - production, summary of, 8-21
 - project, 10-4
 - rehabilitation, 6-13
 - repair, 8-23
 - retrofit improvements, 7-9
 - rework, 6-9
 - scrapped product, 6-9, 6-16
 - single setup, 8-16
 - soft, 9-11
 - storage, 8-15
 - training, 7-9
 - turnover, 7-9, 7-10, 9-7
 - workers' compensation, 6-8
 - claim, 9-3
 - small-industry, 13-3
- Cost benefit of ergonomics, corporate perspective of, 9-1 to 18
 - case studies, 9-14 to 18

- costs associated with ergonomic mismatches, 9-3 to 8
- influence of corporate culture on cost benefit analysis, 9-10 to 14
 - methods for justifying ergonomic interventions, 9-8 to 10
 - organizational need for ergonomics, 9-2 to 3
- Council of Accreditation in Occupational Hearing Conservation (CAOHC), 16-30
- CPU recognition system, 25-9
- Crews, ergonomics of, 8-24
- CSR index, *see* Cumulative stress reduction index
- CTDs, workers' compensation for, 12-20
- CTS, *see* Carpal tunnel syndrome
- Cuban Missile Crisis, 12-4
- Cultural change, *Tuttava* as vehicle for, 3-13
- Cultural dynamics model, 4-2
- Culture change, 10-8
- Cumulative stress reduction (CSR) index, 10-4
- Cumulative trauma, 4-13, 12-18
- Customer services, *see* Corporate cost avoidance using sound ergonomics technology and quality-based customer services

D

- DAT, *see* Digital audio tape
- Data
 - collection, 12-16, 12-17
 - entry, offshore, 1-1
- Database(s)
 - audiometric, 16-28
 - Web-based, 12-28
- Decision
 - analysis, 6-17
 - making, top-down, 12-4
- Deep mines, heat stress and, 29-10
- Defect(s)
 - detection, 4-2
 - workmanship, 4-12
- Delayed cash flow streams, 8-10
- Demand, creating and responding to, 5-7
- Department of Energy (DOE), 5-8
- Design for automation (DFA), 26-1, 26-15
- Design for human assembly (DHA), 26-1 to 17
 - human factors principles in design for assembly, 26-7
 - minimizing decision time, 26-9 to 11
 - minimizing manipulation time, 26-11 to 15
 - minimizing perception time, 26-7 to 9
 - MTM analysis of assembly process, 26-3 to 7
 - product design for automation using Boothroyd's principles, 26-2
- Design trade-offs, 27-2
- Desktop videoconferencing, 27-6
- Deterioration costs, 8-6
- Development
 - costs, 6-7
 - gridlock, *Tuttava* and, 3-8
- DFA, *see* Design for automation
- DHA, *see* Design for human assembly
- Diagnosis Information System (DIS), 24-8
- Dialogue, 22-12 to 15
- Digital audio tape (DAT), 17-4
- Direct claim costs, 9-3
- Discounted cash flows, 8-3, 8-8
- Discrete exponential model, 8-13
- Discrete series models, 8-5
- Display luminance, 22-8
- DOE, *see* Department of Energy
- Dosimeter, noise logging, 16-11
- Down-ramp series, 8-7
- Dry bulb temperature, 18-8
- Dual-task performance, 18-27

E

- Earmuffs, 16-25, 16-28
- EC, *see* Ergonomics coordinator
- Economic advantages, 8-1
- Economic analysis, 6-1 to 20
 - fundamentals, 6-2 to 13
 - method application, 6-13 to 19
- Economic–ergonomic interactions in design and management, 8-1 to 33
 - automated highway design, 8-26 to 29
 - economics of learning, forgetting, and training, 8-13 to 23
 - effects of lack of manufacturing specification on repair, 8-23
 - identification of costs, benefits, and required investments, 8-2 to 3
 - interest calculations and discounted cash flows, 8-3 to 5
 - parallel processing ergonomics, 8-24 to 26
 - personnel selection economics, 8-29 to 31
 - present worth of cash flow series and functions, 8-5 to 11
 - time savings of human operators, 8-11 to 12
- Economic justification of ergonomics process, 7-1 to 11
 - background, 7-1 to 2
 - cost justification methods, 7-3 to 6
 - determination of full cost of injury, 7-6 to 8
 - intangible benefits, 7-2 to 3
 - management duties in corporation, 7-2
 - other costs to consider, 7-9 to 10
 - prediction of future injuries, 7-9
 - tangible information, 7-3
- Economics
 - parallel processing, 8-24
 - personnel selection, 8-29
 - pragmatic principle of, 8-31
- EEO, *see* Equal Employment Opportunity
- Effective temperature (ET), 18-9, 18-22
- EI, *see* Employee involvement
- Electronic media, 27-9
- Electronic networks, participatory ergonomics and, 2-5
- Electronic speech communications, 16-9
- E-mail, 27-6
- Emergency stop button, 28-1
- Employee(s)
 - awareness, 5-6
 - complaints, 9-2
 - empowerment, 3-2
 - frustrated, 3-12
 - involvement (EI), 1-2, 3-2, 13-6, 13-7
 - reports, 13-12
 - self-interest, 4-3
 - severance costs, 6-7
- Employer's insurance provider, 9-17
- End-effector, 2801
- Energy metabolism values, 18-11
- Engineering
 - changes, 13-15
 - management, often-cited axiom of, 27-8
- Environmental, safety, and health (ES&H), 5-6
 - advanced ergonomics for, 5-6
 - manual, Sandia, 5-7
 - organization, benchmark for interdisciplinary matrixed projects within, 5-7
 - staff, budget reductions and, 5-13
- EPW, *see* Ergonomic Project Worksheet
- Equal Employment Opportunity (EEO), 13-5
- Equivalent continuous interest rate, 8-4, 8-8
- Erect posture, 20-2
- Ergo-babble, 10-7
- Ergonomic interventions, methods for justifying, 9-8
- Ergonomic mismatches, costs associated with, 9-3
- Ergonomic practitioners, 4-8
- Ergonomic problem, lowest cost method to resolve, 10-5
- Ergonomic process, 11-1 to 7

Ergonomic processes, small-industry perspective of, 13-1 to 17
 Ergonomic Project Worksheet (EPW), 6-2, 6-4, 6-5, 6-13
 Ergonomics
 coordinator (EC), 5-3
 definition of, 12-2
 /human factors, tenets of, 1-3
 initiatives, justifying, 9-14
 management view of, 10-3
 process flow chart, 12-10
 program
 communication characteristics, 12-25
 stages, 10-9
 steering team, 14-5
 Ergonomic self-reliance, 14-1
 Ergonomics process, large industry perspective of, 12-1 to 29
 background, 12-1 to 2
 computers, internets, and ergonomic communication, 12-23 to 28
 definition of ergonomics, 12-2 to 3
 lessons learned, 12-28 to 29
 organizational issues, 12-3 to 9
 recommended methods of data collection, 12-16 to 23
 recommended methods for implementing plant ergonomics program, 12-9 to 16
 statement of need, 12-2
 Ergonomics training, role of in industry, 14-1 to 10
 characteristics of good training, 14-9
 identifying audience and type of training, 14-4 to 7
 justifying need for ergonomics training, 14-3 to 4
 measuring impact of ergonomics training, 14-7 to 9
 training and macroergonomics approach, 14-2
 ErgoSmart[®], 5-7
 Error(s)
 estimation, 8-7
 -free manufacturing, 1-6
 human
 consequences, 1-2, 14-3
 participatory ergonomics and, 2-4
 process design exceeding human cognitive skills and, 4-8
 software and, 27-11
 management, 12-4
 message, 22-3
 mis-processing, 27-10
 ES&H, *see* Environmental, safety, and health
 ET, *see* Effective temperature
 ETA, *see* Event Tree Analysis
 Evaluation, categories of, 19-11
 Evaporation, sweat, 18-3
 Event Tree Analysis (ETA), 30-8
 Excel[™], 22-8
 Expert help, 10-5
 Expert training, 12-14 to 16
 Exposure–symptom association, 15-1

F

FAA, *see* Federal Aviation Administration
 Failure mode, 28-3
 Fast Fourier Transform (FFT), 17-3
 algorithms, 16-16
 analyzers, 17-3
 Fault Modes and Effect Analysis (FMEA), 30-8
 Fault tree, 2-3, 28-3
 Federal Aviation Administration (FAA), 34-16, 34-20
 Federal Highway Administration (FHA), 8-27
 Feedback
 chart, 3-10
 period, 3-11
 skills, 11-3
 systems, 12-24

Filter self rescuers (FSRs), 29-17
 Financial calculations, gradient, 8-7
 Fitting jobs to people, 12-1
 Flexible manufacturing systems (FMS), 24-6
 Flight service stations (FSSs), 34-2
 Floundering, 10-1
 FMEA, *see* Fault Modes and Effect Analysis
 Ford Motor Company, 12-8
 Forgetting, economics of, 8-13
 Forward Kansei Engineering, 25-6
 Fourier spectrum analysis, 17-4
 Free flight, 34-18
 Freehand[™], 22-8
 Fully developed losses, 9-4
 Fuzzy logic, 25-5
 Fuzzy set theory, 25-9

G

Gap effect, 8-18
 Global competition, 1-1
 Goal setting, 11-3
 example of, 3-7
 identification of, 3-6
 Good-up Bra, 25-7
 Good work practices
 Grasping, design of process to enhance, 26-12
 Grazing incident response, 16-13
 Group
 benefit, 9-6
 prediction, 19-4

H

Hand-arm vibration (HAV), 17-1
 curves, 17-11
 measurements, 17-4, 17-5
 syndrome (HAVS), 17-10
 Hazard
 analysis, 19-12
 examples, 30-6 to 8
 identification, 30-6
 Hazard and operability study (HAZOP), 28-3, 30-8
 Hazardous situation
 complex, 30-11
 injuries as result of, 30-14 to 15
 occupational diseases as consequence of, 30-16
 HCI standard, *see* Human Computer Interaction standard
 HCP, *see* Hearing conservation program
 Health care
 professional, 13-9
 sectors, fundamental concerns of, 31-3
 Health care organizations, 31-1 to 12
 common injuries and illnesses, 31-2 to 31-3
 elements of ergonomics programs in health care, 31-8 to 9
 ergonomics creeping into health care, 31-2
 ergonomics programs in health care, 31-7 to 8
 fundamental concerns of health care sectors, 31-3 to 7
 health care as large and diverse industry, 31-1 to 2
 Hearing
 conservation program (HCP), 16-23
 protection devices (HPDs), 16-23, 16-25, 16-29
 Heat
 acclimatization, 18-5
 effects, vigilant tasks and, 18-24
 measurement, metabolic, 18-10
 stress
 deep mines and, 29-10
 effects of on health, 18-5
 illnesses and disorders, 18-6 to 7

index (HSI), 18-8, 18-9
 limits, 18-19, 18-20, 18-21
 measurement of, 18-8
 problems, 18-2
 stroke, 18-5
 Heavy work, permissible working times for, 18-11
 High-technology systems, principal criterion of, 18-1
 Hip-pocket solution, 12-8
 Hiring costs, 7-9
 Holding cost, 8-15
 Hospital representative, 12-12
 Hourly workers, training for, 14-6
 Housekeeping, 3-2, 3-3
 HPDs, *see* Hearing protection devices
 HSI, *see* Heat stress index
 Human capability, 4-6, 4-9, 4-11
 Human Computer Interaction (HCI) standard, 22-17
 Human-computer interface requirements, 22-1 to 20
 future requirements for U.S., 22-17 to 18
 requirements based on ISO 6385, 22-4
 requirements and recommendations of ISO 9241, 22-5 to 17
 standards, 22-2
 systematic approach, 22-3
 Human error(s)
 consequences, 1-2, 14-3
 participatory ergonomics and, 2-4
 process design exceeding human cognitive skills and, 4-8
 software and, 27-11
 Human interfaces, realization of agility and, 27-1
 Human-machine system, 4-12
 Human merge, 2-7
 Human operators, time savings of, 8-11
 Human resources management, impact of TQM on, 1-4
 Human scrap, 9-9
 Human thermoregulation, 18-4
 Hyperacusis, 16-10
 Hyperthermia, 18-4
 Hypothermia, 18-4
 Hypoxemia, 21-2

I

IAP, *see* Intra-abdominal pressure
 ICE, *see* Interactive Collaborative Environments
 Illness costs, comparison of program costs and, 5-11
 Improvement change process, management commitment and, 4-3
 In-class training, 27-11
 In-depth training, 13-10
 Indirect claim costs, 9-3
 Industrial ergonomics, training issues in, 15-1 to 18
 overview of literature on training in ergonomics, 15-13 to 15
 systematic design of training programs, 15-2 to 13
 Industrial ergonomics programs, success factors for, 10-1 to 13
 business objectives, 10-2 to 3
 creation of strategic plan, 10-10
 creation of tactical plan, 10-10 to 11
 definition of ergonomics program purpose, 10-7
 difference between ergonomics program and practice of ergonomics, 10-10
 efficient use of resources, 10-5
 ergo-babble, 10-7
 identifying and overcoming barriers, 10-6
 low-value/high-cost solutions, 10-3
 political support, 10-13
 quantitative evaluation of ergonomics projects, 10-3 to 4
 quantitative evaluations of overall ergonomics program, 10-11 to 12

 stages of ergonomics culture change, 10-8 to 10
 tabulation of cost of projects, 10-4
 top management support, 10-12 to 13
 training supported by suitable infrastructure, 10-6
 Industrial hearing conservation program, 16-31
 Industrial Relations Manager, 12-12

Information

 flow, two-way, 2-1, 2-2
 loop, 2-7
 parallel flow of, 27-7
 sharing, 11-3
 uncertainty, 24-6

Injury(ies)

 common, 31-2
 determination of full cost of, 7-6 to 8
 incidence rates, 13-4
 knee, 33-2
 minimizing potential for, 4-12
 percentage, 30-26
 prediction of future, 7-9
 repetitive labor, 9-1
 sprain and strain, 33-1
 Input devices, requirements for, 22-9
 Instructional systems development (ISD), 15-3
 Insurance provider, employer, 9-17
 Interactive Collaborative Environments (ICE), 27-6
 Interest, 8-3 to 8-4, 8-6
 Internet, participatory ergonomics and, 2-5
 Intervention costs, 12-17, 12-22
 Interview reports, 13-12
 Intra-abdominal pressure (IAP), 15-8, 29-8, 29-9
 Intranet, Sandia, 5-7

Inventory

 buildup, present worth of, 8-16
 cost, 8-15, 8-16, 8-21
 dispensing, 8-18
 present worth, total, 8-17
 ISD, *see* Instructional systems development
 ISO 6385, 22-4
 ISO 9000, 4-1
 ISO 9241, 22-1, 22-2, 22-3, 22-5, 22-10
 ISO standards, 16-8

J

Jack leg drill, 29-17
 Job
 aid, definition of, 8-23
 analysis, 24-5
 design, poor, 12-14
 identification system, 12-19
 knowledge, lack of, 12-6
 requirements, 32-4
 rotation, 33-5

K

Kaizen, 24-1
 Kansei Engineering (KE), 25-1 to 14
 applications of, 25-6 to 12
 types of, 25-2 to 6
 Keyboard-intensive work, extremes of, 20-13
 Knee injuries, 33-2
 Knowledge -based barriers, 12-6
 Knowledge elicitation techniques, 27-2
 Knowledge skills, abilities, and other characteristics (KSAOs), 15-3

L

- Labor
 - management group, 33-8
 - representatives, training for, 14-6
- LBP, *see* Low back pain
- Learning
 - domain, training delivery techniques in, 15-10
 - economics of, 8-13
 - outcomes
 - desired, 15-4
 - taxonomy of, 15-6
 - rate improvement, 8-22
 - speed improvement, 8-22
 - theory, training and, 14-9
- LifeGuard®, 5-7
- Life-time employment, 4-6
- Lifting
 - devices, 3-7
 - injuries, 5-8
- Light duty assignment, cost of, 6-13
- Lighting equipment manufacturers (LEMs), 29-15
- Lockheed-Martin, 5-12, 5-13
- Long-term disability (LTD), 9-6
- Lordosis, 20-5
- Loss(es)
 - estimating probability and value of, 9-7
 - fully developed, 9-4
 - information, extrapolation to predict future, 9-8
 - vs. goods sold, 7-4 to 5
- Loudness
 - contours, 16-5
 - scales, 16-3
- Low back pain (LBP), 15-1
- Low-seam mines, 29-8
- Luminance, display, 22-8

M

- Machine down time, 12-23
- Macroergonomics, 2-8, 14-2
- Maintenance supervisor, 12-12
- Make-it-work changes, costs associated with, 4-7
- Malcolm Baldrige Award, 5-12
- Management
 - all purpose bit of advice for, 9-11
 - change, 10-8
 - commitment, 11-3
 - employee involvement and, 13-6, 13-7
 - improvement change process and, 4-3
 - engineering, often-cited axiom of, 27-8
 - error, 12-4
 - theory, impact of TQM on, 1-4
- Man–machine
 - environment system, 30-2
 - interface, 12-15
- Manufacturing
 - competitiveness, drive for, 13-3
 - error-free, 1-6
 - facility, action plan, 12-12
- Market-in concept, 25-1
- MARR, *see* Minimum acceptable rate of return
- Masked sound, 16-7
- Masked threshold, 16-7
- Masker, 16-7
- Masking, 16-7, 16-8
- Material(s)
 - characteristic of, 3-3
 - handling problem, 10-4
- Maximum voluntary contraction (MVC), 23-3
- Mazda, 25-3
- Medical cost system, 12-19
- Medical data collection, 12-17
- Medical devices, 31-6
- Medical management, 5-6, 6-6
- Medical treatment, task description and, 4-13
- Mental model, ease of formation of, 26-9
- Mental performance
 - simple, 18-27
 - tasks, 18-18
- Message storage, data link capabilities for, 34-13
- Metabolic heat measurement, 18-10
- Microphone
 - calibration, 16-17
 - response, 16-13
- Microphonics, 16-10
- Mine(s)
 - deep, heat stress and, 29-10
 - low-seam, 29-8
- Miner aerobic capacity, 29-4
- Mine and Safety Health Administration (MSHA), 16-23
- Minimum acceptable rate of return (MARR), 6-12, 8-5, 8-7
- Mining, ergonomics issues in, 29-1 to 23
 - characteristics of underground mining workforce, 29-3 to 5
 - defining terms, 29-18
 - demands of physical work in underground mining, 29-5 to 10
 - epidemiology of work-related musculoskeletal disorders in mining, 29-2 to 3
 - equipment and tool design, 29-12 to 17
 - hand tool design, 29-17
 - heat stress, 29-11 to 12
 - personal protective equipment, 29-17
 - physical work in restricted postures, 29-10 to 11
 - status of knowledge and unresolved issues, 29-17 to 18
- Misapplication hypothesis, 19-1
- Mis-processing errors, 27-10
- Model(s)
 - biomechanical, 29-9
 - CAD, 27-4
 - conceptual, training program function, 15-2
 - continuous, 8-8, 8-9
 - control by permission, 34-18
 - cultural dynamics, 4-2
 - discrete exponential, 8-13
 - discrete series, 8-5
 - EMG-assisted, 29-10
 - ergonomic precepts, 4-8
 - mental, ease of formation of, 26-9
 - Navon–Gopher, 8-2
 - organizational, 12-3
 - Organizational Politics, 12-4, 12-5
 - Oxenburgh's, 9-9, 9-10
 - participatory improvement, 3-4
 - project team, 305
 - Rational Actor, 12-3
 - serial, estimating parameter r in, 8-9
 - work schedule impact, 19-5
- Modification, 4-11, 4-12
- Money, time value of, 6-11
- Money pit, 10-3
- Monitor flicker, 22-7
- Most Improved Safety Record, 14-9
- Motion Time Measurement (MTM), 26-3
- Motivation, 11-3
- MSHA, *see* Mine and Safety Health Administration
- MTM, *see* Motion Time Measurement
- Musculoskeletal disorders, *see* Computer work, psychosocial factors and musculoskeletal disorders in
- Musculoskeletal injuries
 - rate of, 5-1
 - risk of, 3-14
- MVC, *see* Maximum voluntary contraction

N

National Institute for Occupational Safety and Health (NIOSH), 18-13, 29-3

- criteria developed by, 18-14
- log method, 16-26
- recommended alert limits, 18-12
- Wing's curve and, 18-17
- Work Practices Guide, 12-21

Navon-Gopher model, 8-2

Negative event

- consequence of, 30-18
- probability of, 30-17

Net Annual Worth determination (NAW), 6-11, 6-12

Net present value (NPV), 9-12

Net Present Worth determination (NPW), 6-11, 6-12

Neutral posture, 20-6

NIHL, *see* Noise-induced hearing loss

NIPTS, *see* Noise-induced permanent threshold shift

NITTS, *see* Noise-induced temporary threshold shift

Noise

- abatement, 16-2
- effects of in occupational settings, 16-6
- exposure
 - limits, 16-23
 - monitoring, 16-24
 - on-the-job, 16-11
- induced hearing loss (NIHL), 16-1, 16-9
- induced permanent threshold shift (NIPTS), 16-10
- induced temporary threshold shift (NITTS), 16-10
- levels, quantifying occupational, 16-18
- logging dosimeter, 16-11

Noise in industry, 16-1 to 32

- effects of noise in occupational settings, 16-6 to 11
- industrial noise regulation and abatement, 16-23 to 31
- measurement and quantification of noise exposures, 16-11 to 22
- sound and noise, 16-2 to 6

Nominal interest rate, 8-3

NPV, *see* Net present value

NPW, *see* Net Present Worth determination

O

Object-oriented analysis and design (OOAD), 24-2

Obstacles, example of, 3-7

Occupational physicians, training for, 14-7

Occupational Safety and Health Administration (OSHA), 13-2

- average noise level, 16-19
- citation potential, 9-2
- ergonomics standard, proposed, 9-3
- logs, 7-9, 12-18
- noise
 - dose, 16-20
 - exposure limits, 16-23
- occupational noise exposure standard, 16-16
- pressure, 12-7
- TWA, 16-20

ODAM, *see* Organizational design and management

Office-related tasks, 5-7

One-time costs, 6-10, 6-17

On-the-job noise exposure, 16-11

On-the-job training, 6-7, 6-14, 27-11

OOAD, *see* Object-oriented analysis and design

Optical character recognition systems (OCRs), 2-5

Organization

- analysis, 15-7
- based barriers, 12-6
- climate, 15-7
- culture, 9-10
- models, 12-3

structure of, 4-5

Organizational design and management (ODAM), 2-8

Organizational Politics Model, 12-4, 12-5

OSHA, *see* Occupational Safety and Health Administration

Otoacoustic emissions, 16-10

Overhead, 6-10

Overtime

- cost of, 6-7
- lost production and, 6-14, 6-15
- measurement, 7-8

Ownership cost rule-of-thumb estimate, machine maintenance, 6-10

Oxenburgh's model, 9-9, 9-10

Oxygen deficiency, 21-2

P

Package delivery industry, 32-1 to 6

- technology-driven ergonomic change, 32-1 to 4
- workplace statistics and job requirements, 32-4 to 6

Pain and suffering, reductions in, 5-8

Parallel processing economics

Participation, 12-8

Participative teams, 12-24

Participatory ergonomics, 2-1 to 9, 11-3

common knowledge, 2-5 to 7

as company-wide activity, 2-2 to 3

concept of, 2-1 to 2

dialog-style VDT guidelines, 2-4 to 5

education, 2-3 to 4

as future ergonomics, 2-8 to 9

measures for occupational safety and health problems and human errors, 2-4

original context of, 2-2

for product development, 2-4

product test charter, 2-5

steps for, 2-3

taking advantage of Internet, 2-5

team building, 2-4

in virtual environment, 2-7 to 8

Payback

method, 9-9

period, 7-4

PDM, *see* Product data manager

PEL, *see* Permissible exposure limit

People benefits, 12-10

Perceived critical boundary, 20-15

Perceived noise level, 16-6

Perception time, 26-7

Perceptual queues, 4-10, 4-11

Performance

index, 3-11

limit curves, 18-25

metrics, 5-7

-related values, 9-11

Permissible exposure limit (PEL), 16-18

Perpendicular incidence response, 16-13

Person

analysis, 15-7, 15-8

-machine-tool combinations, 8-25

Personal protective equipment (PPE), 33-6

Personnel selection

economics, 8-29

ratio, 8-29

PHA, *see* Preliminary Hazard Analysis

Physiological degradation, 18-28

Physiological strain, psychosocial demands creating, 23-2

Physiological tolerance, 18-27

Pilot data link communication protocol, 34-13

Plant ergonomics committee, 12-12

Plant ergonomics program

- recommended methods for implementing, 12-9
- training needs, 12-13 to 16
- Plant safety engineer, 12-12
- Polar response, 16-13
- Posture(s)
 - effect of on metabolic cost, 29-5
 - erect, 20-2
 - neutral, 20-6
 - restricted, manual materials handling in, 29-7
 - seated
 - ecology of, 20-10
 - system goals in, 20-3
 - static work, 23-3
 - unsupported seated, 20-5
 - upright, 20-2
 - in VDT work, 21-5
 - working, most correct, 21-6
- Potential assistance, 4-10, 4-11
- PPE, *see* Personal protective equipment
- Predetermined time and motion studies (PTMS), 26-3, 26-7
- Preliminary Hazard Analysis (PHA), 30-8
- Prescriptive zone, 18-25
- Presence communication, 2-7, 2-8
- Present worth
 - calculations, 8-20
 - changes, 8-22
 - definition of, 8-5
 - inventory buildup, 8-16
 - total inventory, 8-17
- Probability chart, 30-25
- Problem
 - analysis, 11-4
 - heat stress, 18-2
 - identification, 11-4
 - solving, 13-13
 - flexible, 4-8
 - participative, 12-7
 - skills, 10-4, 10-5
 - stratification, 10-5
 - spaces, degrees-of-freedom, 20-6, 20-11
- Process(es)
 - application of ergonomic precepts to, 4-7
 - design, human factors element of, 4-6
 - not clearly defined, 4-4
 - owners, extensive training of, 4-12
- Process-Oriented Task Analysis (PTA), 24-2
- Product
 - data manager (PDM), 27-3, 27-4
 - development, *see* Kansei Engineering
 - quality, ergonomist and, 7-1
 - test charter, 2-5
- Production
 - costs, 6-6, 8-21
 - lost, 6-14, 6-15
 - out concept, 25-1
 - time, total, 8-14
- Productivity
 - benefits, 7-9
 - changes, 6-8, 6-9
 - data, 12-21
 - demand for, 14-4
 - ergonomics and, 9-9
 - lowered, 7-7
 - measurement, 7-8
- Program
 - implementation, serious threat to, 11-5
 - record, 6-3 to 6-5
 - cost and savings included in, 6-6
 - line item values for, 6-13
 - roll-out, visualization of, 10-10
 - success, ultimate metric for, 5-9

- Project(s)
 - cost of, 10-4
 - evaluations, 6-11
 - team models, 3-5
- Proposal and schedule, 19-11
- Psychomotor domain, 15-6
- PTA, *see* Process-Oriented Task Analysis
- PTMS, *see* Predetermined time and motion studies

Q

- QPEP project, *see* Quality, Working Environment and Productivity project
- Quality
 - circles, authority and, 12-8
 - demand for, 14-4
 - goal of, 4-3, 4-5, 4-6
 - major element for achieving, 4-5
 - metrics and awards, 5-11
 - rates, data for, 12-21
 - similarities between safety and, 1-4
 - surveys, 5-11
- Quality and ergonomics, 4-1 to 14
 - human element and continuous improvement, 4-2 to 3
 - measuring results, 4-12 to 13
 - method of developing ergonomic-oriented processes, 4-8 to 12
 - organizational process orientation, 4-3 to 5
 - utilizing ergonomic precepts to design processes, 4-5 to 8
- Quality, Working Environment and Productivity (QPEP)
 - project, 1-5
- Questionnaires, self-administered, 12-18
- QWERTY keyboard, 15-1

R

- Ramp series, varieties of, 8-7
- Random incidence response, 16-13
- Rate-of-return charts, 12-10, 12-11
- Rational Actor Model, 12-3
- Reach envelopes, 20-14
- Real-time analyzers, 16-16, 17-3
- Recommended alert limits (RALs), 18-12, 18-21
- Recommended exposure limits (RELs), 18-12
- Reflex sympathy dystrophy (RSD), 9-17
- Refresher training, 13-10
- Rehabilitation costs, 6-13
- Remote masking, 16-8
- Repair, 8-23
- Repetitive labor, 9-1
- Repetitive work, problems of, 1-5
- Resonance, 17-3
- Resources room, 5-4
- Restricted postures, manual materials handling in, 29-7
- Results-oriented statistics, 6-19
- Retrofit improvements, costs of, 7-9
- Returned-call delays, 5-3
- Return-on-Investment (ROI), 5-9, 6-12, 6-19
- Return-to-Work (RTW), 4-13, 9-17
- Rework costs, 6-9
- Risk(s)
 - acceptability, 30-5
 - assessment process, efficient, 30-23
 - definition, extended, 30-19
 - elimination of, 30-21
 - evaluation, 30-16
 - factors, poor job design, 12-14
 - levels, graphic display of, 30-28
 - management scheme, 30-2
 - ranking of, 30-25

- technical, 30-23
 - Risk assessment and safety management in industry, 30-1 to 29
 - arrangements for decrease of elimination of risk, 30-21 to 22
 - assessment if requirements of obligatory regulations and standards are fulfilled, 30-14 to 16
 - assessment of system safety, 30-21
 - establishment of priorities, 30-22
 - example of risk assessment methods, 30-22 to 28
 - identification and analyses of hazardous situations, 30-8
 - identification of hazard, 30-6 to 8
 - performance of hazardous situation analyses, 30-9 to 14
 - performer of activities, 30-3 to 4
 - provision of information for assessors, 30-4 to 5
 - risk evaluation, 30-16 to 20
 - selection of assessed system, 30-5 to 6
 - Robot(s)
 - accidents, 28-2
 - code, 27-10
 - first use of for assembly, 26-1
 - risks zones for stationary, 28-4
 - Robotics, occupational safety in, 28-1 to 11
 - defining terms, 28-5 to 8, 25-9
 - risk zones for stationary robots, 28-4
 - robot accidents and safety analysis, 28-2 to 3
 - robotic safety standards, 28-5
 - ROI, *see* Return-on-Investment
 - Rotating hours, 19-3
 - Rough analysis, preliminary, 30-14
 - RSD, *see* Reflex sympathy dystrophy
 - RTW, *see* Return-to-Work
- S**
- Safety
 - arrangements priority, 30-21
 - culture, 3-12
 - improvement program, ergonomics-oriented, 4-1
 - management, *see* Risk assessment and safety management in industry
 - productivity costs related to, 9-9
 - similarities between quality and, 1-4
 - values, demonstrating, 9-11
 - Salary continuation expenses, 9-5
 - Sandia National Laboratories (SNL), 5-1
 - ES&H manual, 5-7
 - intranet, 5-7
 - Licensing and Partnership Department, 5-13
 - President's Quality Award, 5-12
 - Scaling bar, 29-17
 - SCM, *see* Strategic Cost Analysis
 - Scrapped product costs, 6-9, 6-16
 - SCSR, *see* Self-contained self-rescuer
 - SD, *see* Semantic differentials
 - Seated posture, system goals in, 20-3
 - Seating and chairs, 20-1 to 20-18
 - applications and examples, 20-7 to 15
 - biomechanical efficiency assumption, 20-4 to 6
 - defining terms, 20-16
 - design specifications, 20-6
 - envelope of postural orientations, 20-4
 - fundamentals, 20-2 to 4
 - multiple-degrees-of-freedom problem spaces, 20-6 to 7
 - Seatpan-backrest angle relationships, 20-12
 - Self-contained self-rescuer (SCSR), 29-14, 29-17
 - Self help, 10-5
 - Semantic differentials (SD), 25-2, 25-4
 - Serial models, estimating parameter r in, 8-9
 - SFB, *see* Sonderforschungsbereich
 - Shift work terms, definitions for, 19-3
 - Shop floor
 - agile, 27-10
 - culture, 27-12
 - Short-term disability (STD), 9-6
 - SIC codes, *see* Standard Industrial Classification codes
 - Signal-to-noise ratio, 16-7
 - Simple mental performance, 18-27
 - Simulation, 4-10, 4-12
 - Single setup cost, 8-16
 - Skilled help, 10-5
 - Skin eruptions, 18-5
 - Sleep, as benchmark, 19-4
 - SLM, *see* Sound level meter
 - Small business, definition of, 13-1
 - Small industry, characteristics of, 13-2
 - SNL, *see* Sandia National Laboratories
 - Soft costs, 9-11
 - Software
 - concerns, parts dealing with, 22-6
 - design, 24-2, 24-7
 - human errors, and, 27-11
 - packages, evaluation of for CEG use, 5-7
 - Software development, user-centered, 24-1 to 12
 - software design as work design, 24-2
 - stages of software life cycle, 24-2 to 10
 - Sonderforschungsbereich (SFB), 24-4
 - Sone
 - modifications of, 16-6
 - scale, 16-4
 - Sound
 - definition of, 16-2
 - intensity level, 16-3
 - masked, 16-7
 - power level, 16-2
 - pressure level (SPL), 16-3, 16-4
 - propagation of, 16-11
 - Sound level meter (SLM), 16-12
 - analog vs. digital readouts, 16-14 to 15
 - applications, 16-15
 - components of, 16-12
 - microphone considerations, 16-13
 - root mean square, 16-14
 - Spatial compatibility, 26-10
 - Spectrum analyzer, 16-15
 - Spine biomechanics, 21-2
 - Spot-audits, 12-27
 - Sprain and strain injuries, 33-1
 - SSD, *see* Strategy-based software design
 - Stakeholders, interviewing, 5-2
 - Standard Industrial Classification (SIC) codes, 13-1, 13-11, 31-1
 - Standard threshold shift (STS), 16-25
 - Statement of need, 12-2
 - Stationary robots, risk zones for, 28-4
 - Statistics, results-oriented, 6-19
 - STD, *see* Short-term disability
 - Stooping
 - coal miner, 29-2
 - handling capacity for, 29-9
 - Storage cost, 8-15
 - Strategic Cost Analysis (SCM), 9-12
 - Strategic plans, 10-10
 - Strategy-based software design (SSD), 24-7
 - Stress
 - criteria, implications for, 18-29
 - exposure limits, *see* Thermal stress, foundational case of human response to, 18-1
 - STS, *see* Standard threshold shift
 - Subunit interests, conflict between, 12-6
 - Success factors, 10-2
 - Suppliers, establishing requirements with, 5-2
 - Surveillance, 13-11, 33-1
 - Sweat evaporation, 18-3

T

Tactical plans, 10-10 , 10-12
 Tariff barriers, removal of, 1-1
 Task(s)
 analysis, 4-9, 15-7, 24-6, 27-8
 assignment, 4-10, 4-12
 chairs, 20-2
 constraints, 20-3
 demands, user performance and, 20-10
 description, medical treatment and, 4-13
 domain, 15-14
 isodecrement curves for tracking, 18-19
 mental performance, 18-18
 mining, energy expenditure for, 29-5
 VDT
 ergonomic training on, 15-14
 psychophysical, 23-2
 vigilant, heat effects and, 18-24
 TASL, *see* Total accumulated sleep loss
 Team(s)
 building, 204
 ergonomics of, 8-23
 management representatives in, 3-6
 participative, 12-24
 skills, 1-6
 TEAMS, *see* Training for Excellence in American Manufacturing and Services, Inc.
 Technical innovation, 4-6
 Technical risks, 30-23
 Technology
 -driven ergonomic change, 32-1
 standardization, 27-8
 Telepresence, 2-7
 Terminal radar-approach control facilities (TRACONs), 34-2, 34-5, 34-7
 Test-interview procedure, 8-30
 TFM, *see* Traffic flow management
 Thermal stress, foundational case of, 18-1 to 33
 current criteria, 18-14 to 18
 foundation for exposure criteria to occupational stress, 18-13 to 14
 implications for all stress criteria, 18-29 to 30
 new descriptive framework, 18-24 to 25
 physiological measures and standards, 18-2 to 13
 prevalence of heat stress, 18-13
 single versus multiple thresholds for criteria, 18-18 to 24
 theoretical foundation of limits derived, 18-28 to 29
 Threshold shift, definition of, 16-10
 Time value of money, 6-11, 7-5 to 6
 Time-weighted average (TWA), 16-18
 energy expenditure, 18-10
 OSHA, 16-20
 workplace, 16-26
 Tinnitus, 16-10
 Tooling, lowering overall costs of, 4-13
 Tools
 characteristic of, 3-3
 good work practices for use of, 3-6
 Total accumulated sleep loss (TASL), 19-6, 19-7
 Total Quality Management (TQM), 4-1
 human factors and, 1-1 to 9
 improving processes for, 4-2
 initiative, 9-15
 Tough jobs, turnover rates, 9-7
 Tracking performance, 18-27
 TRACONs, *see* Terminal radar-approach control facilities
 Trading blocs, creation of, 1-1
 Traffic
 flow management (TFM), 34-1, 34-4, 34-14
 volumes, excessive, 8-26

Training

awareness, 12-13, 13-10
 characteristics of good, 14-9
 company process, 4-8
 costs, 6-6, 7-9
 delivery techniques, 15-10
 design engineers, 14-7
 development stage, 15-9
 economics of, 8-13
 effectiveness, 15-11 to 13
 evaluation, purposes for conducting, 15-12
 expert, 12-14 to 16
 hourly workers, 14-6
 human resource managers, 14-7
 in-class, 27-11
 in-depth, 13-10
 justifying need for, 14-3
 labor representatives, 14-6
 occupational physicians, 14-7
 on-the-job, 6-7, 6-14, 27-11
 pay, 7-10
 programs
 evaluation of, 8-22
 systematic design of, 15-2
 refresher, 13-10
 research, 15-3
 transfer of, 15-13
 Training for Excellence in American Manufacturing and Services, Inc. (TEAMS), 4-2
 Turnover
 cost, 6-7, 7-9, 7-10
 rates, tough jobs, 9-7
 stressful jobs and, 13-12
 Tuttava, 3-1 to 15
 behavioral changes, 3-8 to 12
 importance of observing conditions instead of behaviors, 3-12
 job analysis and identification of improvement goals, 3-6 to 7
 organization, 3-5 to 6
 proven benefits, 3-13 to 14
 removal of technical or organizational obstacles, 3-7 to 8
 safety culture, 3-12 to 13
 strategies for improving workplaces, 3-1 to 2
 what housekeeping really can offer for workplace improvement, 3-2 to 4
 TWA, *see* Time-weighted average

U

U-Hypothesis, 8-29, 8-31
 Undiscounted cash flows, cumulative sum of, 8-6
 Union chairperson, 12-12
 United Auto Worker shops, strike by, 12-7
 Upper extremity cumulative trauma disorders (UECTDs), 7-3
 Upright posture, 20-2
 Upward masking, 16-8
 User friendliness, 22-11

V

Validity coefficient, 8-29, 8-30
 Value(s)
 actual time series of, 8-6
 chain analysis, 9-12
 corporate values, 9-11
 -focused thinking, 9-10
 VDT, *see* Video display terminal
 VDT work, seating and posture in, 21-1 to 13
 elements of spine biomechanics, 21-2

musculoskeletal disorders in VDT work, 21-3 to 5
 nutrition mechanism of intervertebral disc and
 paravertebral soft tissue, 21-2 to 3
 organizational factors, 21-9 to 10
 requirements and characteristics of VDT workstation, 21-6
 to 9
 seating and posture in VDT work, 21-5 to 6
 Vector quantity, 17-1
 Vibration
 hazard severity, underestimation of, 17-9
 measurements, 17-4
 Vibrometry, 17-1 to 13
 defining terms, 17-12
 occupational vibration standards/guides, 17-7 to 10
 vibration basics, 17-1 to 3
 vibration measurements basics, 17-4 to 7
 Video camcorder, recording of workers using, 17-6
 Video display terminal (VDT), 21-1
 -based psychophysical tasks, 23-2
 guideline(s)
 dialogue-style, 2-4
 opening part of non-parametric, 2-6
 -related tasks, ergonomic training on, 15-14
 workers, influence of physical factors on health among, 23-1
 Vigilance performance, 18-27
 Vigilant tasks, heat effects and 18-24
 Virtual Co-location, 27-6
 Virtual Corporation, 27-6, 27-10
 Virtual factory, 207
 Virtual reality, 2-2, 2-5, 25-6
 Visible improvements, 3-12
 Vision statements, examples of, 10-8
 Visual discrimination, 26-8
 Visual display requirements, 22-6
 Visualization, 27-5
 Voluntary Protection Program (VPP), 13-4
 VR, presence communication and, 2-7

W

Wages, 6-9
 Waveform, period of, 16-2
 Wavelength, 16-2
 Weather forecasting, 34-15
 Web-based databases, 12-28
 Web-based technologies, 27-6
 Wet bulb globe temperature (WBGT), 18-9, 18-22, 18-27
 Wet bulb temperature, 18-8
 Wet globe temperature (WGT), 18-9
 WGT, *see* Wet globe temperature
 Whole-body vibration (WBV), 17-1, 29-13
 comfort criteria, 17-8
 health effects, 17-9
 measurements, 17-5
 standards, 17-7

 vehicle measurements, 17-6
 Wing's curve, 18-17
 Work
 demands, high, 4-4
 habits, safely productive, 3-4
 performance, impact of TQM on theory of, 1-4
 postures, static, 23-3
 -related musculoskeletal disorders (WMSDs), 15-1, 29-2
 repetitive, problems of, 1-5
 schedule impact model, 19-5
 shift
 assessment report, 19-13
 hazards, 19-8
 implementation, 19-15
 perceptions, preliminary assessment of, 19-9
 Worker
 -management participation, 12-7
 productivity, 5-1
 satisfaction data, 12-21
 Workers' compensation
 case, chronic, 9-17
 claim, 9-3 to 4
 costs, 6-8, 13-3
 CTD, 12-120
 insurance costs, escalating, 9-2
 Working posture, most correct, 21-6
 Workmanship defects, root-cause analysis of, 4-12
 Workplace
 assessment, 19-14
 biomechanics, 5-7
 designers, lack of specific job knowledge by, 12-6
 ergonomics, vehicle for improving, 3-1
 improvements 3-1 to 2
 statistics, 32-1, 32-4
 TWA, 16-26
 Work shift usability testing, 19-1 to 18
 workplace assessment, 19-13 to 15
 work shift assessment, 19-9 to 13
 work shift implementation, 19-15
 work shift usability testing, 19-1 to 9
 Worksite evaluations (WSEs), 5-3, 5-4, 5-5
 Workstation(s)
 analysis, 13-14
 CNC-, 24-5
 Worth, present, 8-5
 calculations, 8-29
 changes, 8-22
 inventory buildup, 8-16
 total inventory, 8-17
 Wright, Frank Lloyd, 20-1
 WSEs, *see* Worksite evaluations

Z

Z-scores, 8-30